

37.0-40.0 GHz GaAs MMIC Buffer Amplifier, QFN

Features

- X 21.0 dB Small Signal Gain
- X +22.0 dBm Psat
- X +20.0 dBm P1dB
- X +30.5 dBm Output IP3
- X Variable Gain with Adjustable Bias
- X 3x3mm, QFN
- X 100% RF, DC and Output Power Testing



General Description

Mimix Broadband's three stage 37.0-40.0 GHz GaAs MMIC buffer amplifier has a small signal gain of 21.0 dB and 20.0 dBm P1dB output compression point. The device also provides variable gain regulation with adjustable bias. The device is ideally suited as an LO or RF buffer stage with broadband performance at a very low cost. The device comes in an RoHS compliant 3x3mm QFN surface mount package offering excellent RF and thermal properties. This device has been designed for use in 38 GHz Point-to-Point Microwave Radio applications.

Absolute Maximum Ratings

Supply Voltage (Vd1,2,3)	+4.3V
Supply Voltage (Vg1,2,3)	-1.5V < Vg < 0V
Input Power (Pin)	+20 dBm
Abs. Max. Junction/Channel Temp	See MTTF Graph ¹
Max. Operating Junction/Channel Temp	150 °C
Continuous Power Dissipation (Pdiss) at 85 °C	1.2 W
Thermal Resistance	47 °C/W
Operating Temperature (Ta)	-55 °C to MTTF Graph ¹
Storage Temperature (Tstg)	-65 to +165 °C
Mounting Temperature	See solder reflow profile
ESD Min. - Machine Model (MM)	Class A
ESD Min. - Human Body Model (HBM)	Class 1A
MSL Level	MSL3

(1) Channel temperature directly affects a device's MTTF. Channel temperature should be kept as low as possible to maximize lifetime.

(2) For saturated performance it recommended that the sum of (2*Vdd + abs(Vg)) < 9V

Electrical Characteristics (Ambient Temperature T = 25 °C)

Parameter	Units	Min.	Typ.	Max.
Frequency Range (f)	GHz	37.0	-	40.0
Input Return Loss (S11)	dB	-	7.0	-
Output Return Loss (S22)	dB	-	10.0	-
Small Signal Gain (S21)	dB	17.0	21.0	24.5
Reverse Isolation (S12)	dB	-	40.0	-
Output Power for 1dB Compression (P1dB)	dBm	-	20.0	-
Saturated Output Power (Psat)	dBm	19.5	22.0	-
Output IP3 (Psci = 4 dBm)	dBm	27.0	30.5	-
Drain Bias Voltage (Vd1,2,3)	V	-	4.0	4.0
Gate Bias Voltage (Vg1,2,3)	V	-1.0	-0.3	-0.1
Supply Current (Id1,2,3)	mA	-	250	300

37.0-40.0 GHz GaAs MMIC Buffer Amplifier, QFN



January 2011 - Rev 10-Jan-11

BI014-QT
RoHS

Buffer Amplifier Measurements

XB1014-QT: Small Signal Gain (S21)
Vd = 4V, Id1 = Id2 = 62.5 mA, Id3 = 125 mA

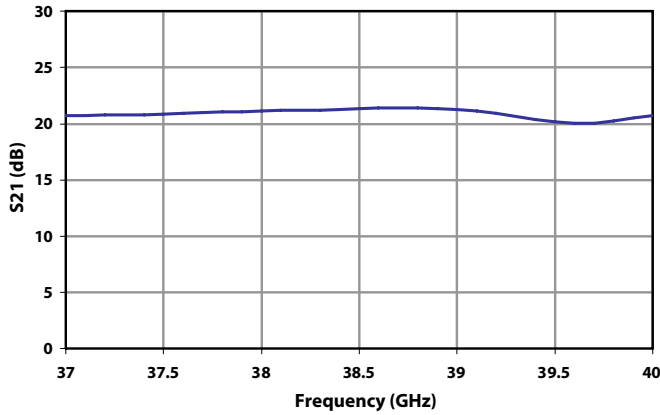

XB1014-QT: Input Return Loss (S11)
Vd = 4V, Id1 = Id2 = 62.5 mA, Id3 = 125 mA

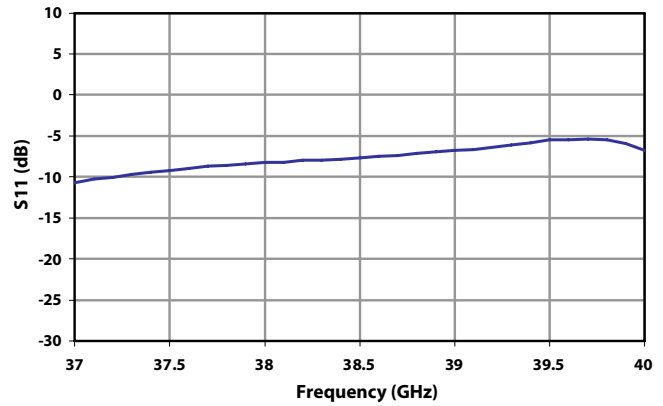

XB1014-QT: Output Return Loss (S22)
Vd = 4V, Id1 = Id2 = 62.5 mA, Id3 = 125 mA

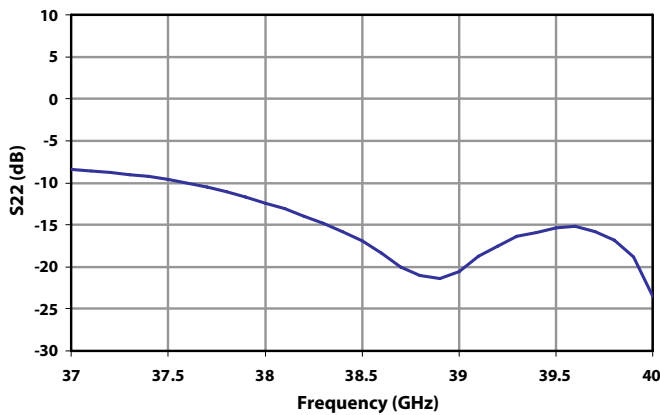

XB1014-QT: Reverse Isolation (S12)
Vd = 4V, Id1 = Id2 = 62.5 mA, Id3 = 125 mA

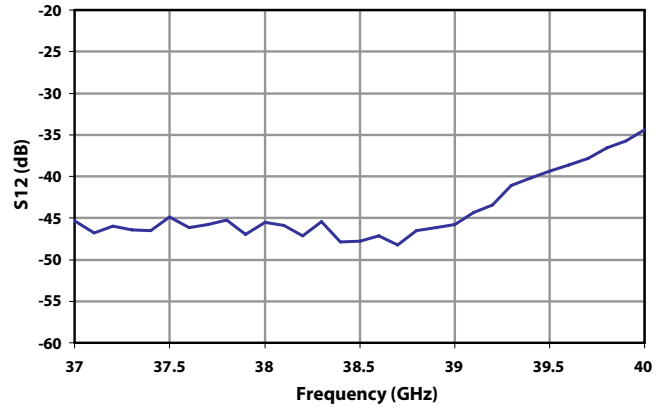

XB1014-QT: OIP3 vs Freq
Psc1 = +5dBm; Vd1,2,3 = 4.0V, Id1 = Id2 = 62.5mA, Id3 = 125mA

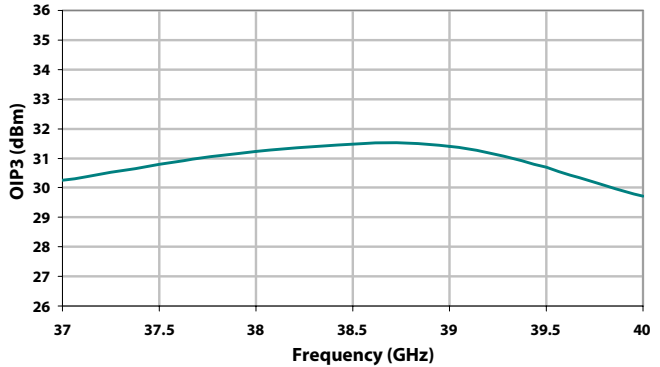

XB1014-QT: C/I3 vs Freq
Psc1 = +5dBm; Vd1,2,3 = 4.0V, Id1 = Id2 = 62.5mA, Id3 = 125mA

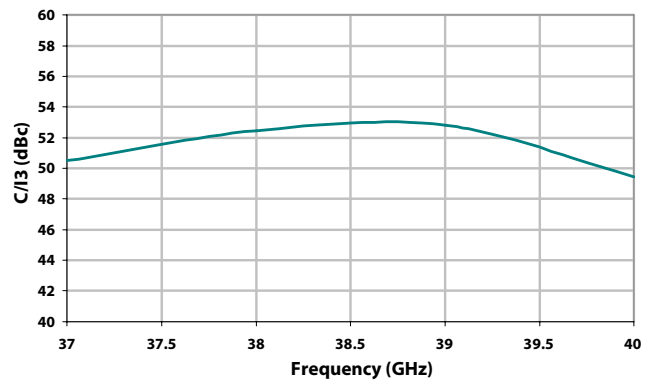

37.0-40.0 GHz GaAs MMIC Buffer Amplifier, QFN

January 2011 - Rev 10-Jan-11

Buffer Amplifier Measurements (cont.)

XB1014-QT: P1dB vs Freq
Vd1,2,3=4.0V, Id1=Id2=62.5mA, Id3=125mA

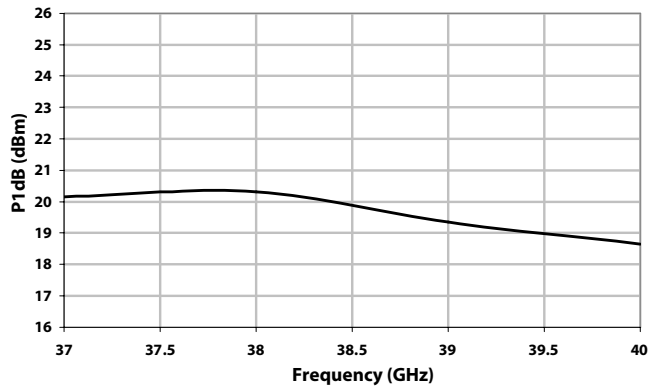

XB1014-QT: Psat vs Freq
Vd1,2,3=4.0V, Id1=Id2=62.5mA, Id3=125mA

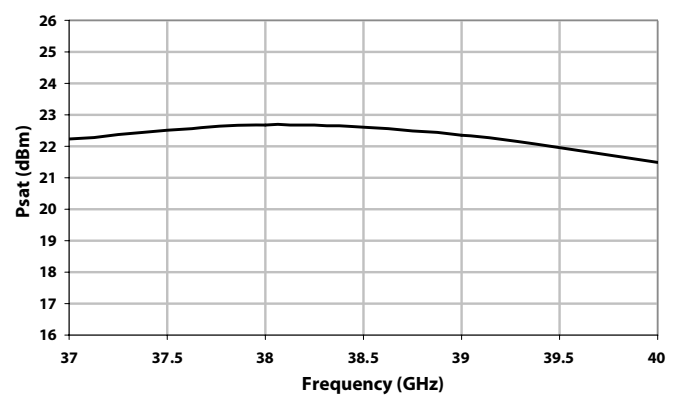

37.0-40.0 GHz GaAs MMIC Buffer Amplifier, QFN

January 2011 - Rev 10-Jan-11

Package Dimensions / Layout

QT (3x3 mm)

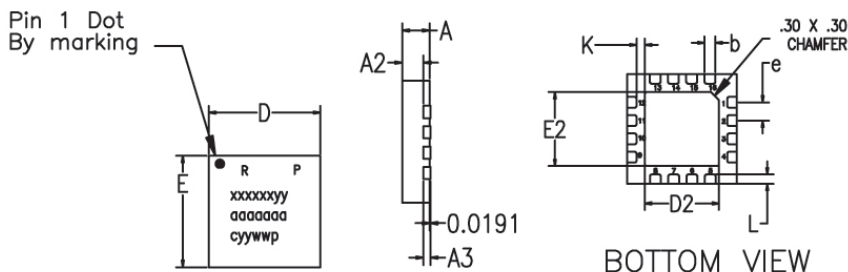

MARKINGS:
PIN 1/BOM REV/PLATING
MIMIX PART/MODEL NO.
WAFER LOT NUMBER
DATE CODE

TOP VIEW

Note:
1. ALL DIMENSIONS ARE IN mm.

RECOMMENDED SOLDER PAD PITCH AND DIMENSIONS

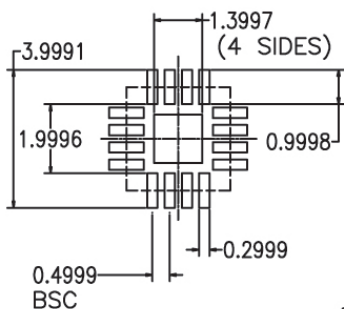

	MIN	TYP	MAX
A	0.80	0.90	1.00
A3	0.20 REF		
A2	0.00	0.65	1.00
b	0.20	0.25	0.30
K	0.20	-	-
D	3.00 BSC		
E	3.00 BSC		
e	0.50		
D2	1.50	1.65	1.80
E2	1.50	1.65	1.80
L	0.16	0.26	0.36

1. VIEWS ARE NOT TO SCALE: USE DIMENSIONS AND TABLE.

Functional Block Diagram/Pin Designations

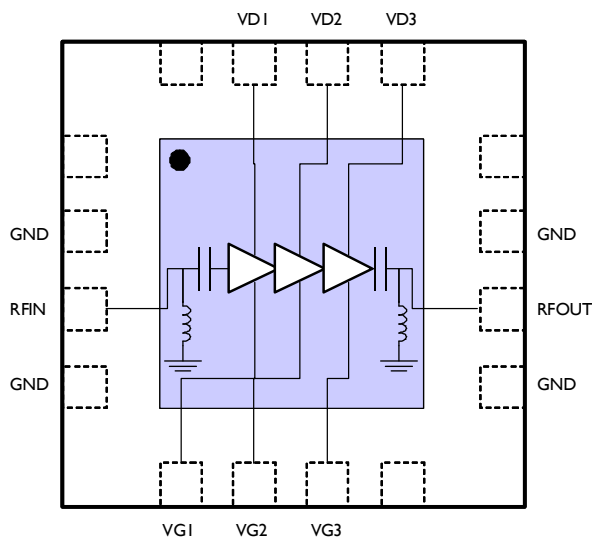

Pin Designations

Pin Number	Pin Name	Pin Function	Nominal Value
3	RF In	RF Input	-
5	VG1	Gate 1 Bias	Approx. -0.3V
6	VG2	Gate 2 Bias	Approx. -0.3V
7	VG3	Gate 3 Bias	Approx. -0.3V
10	RF Out	RF Output	-
13	VD3	Drain 3 Bias	4V, 125 mA
14	VD2	Drain 2 Bias	4V, 62.5 mA
15	VD1	Drain 1 Bias	4V, 62.5 mA

37.0-40.0 GHz GaAs MMIC Buffer Amplifier, QFN

App Note [1] Biasing - It is recommended to bias the amplifier with $V_d=4.0V$ and $I_{d_TOTAL}=250mA$. It is also recommended to use active biasing to keep the currents constant as the RF power and temperature vary; this gives the most reproducible results. Depending on the supply voltage available and the power dissipation constraints, the bias circuit may be a single transistor or a low power operational amplifier, with a low value resistor in series with the drain supply used to sense the current. The gate of the pHEMT is controlled to maintain correct drain current and thus drain voltage. The typical gate voltage needed to do this is $-0.3V$. Typically the gate is protected with Silicon diodes to limit the applied voltage. Also, make sure to sequence the applied voltage to ensure negative gate bias is available before applying the positive drain supply.

App Note [2] Bias Arrangement -

Each DC pin (V_d and V_g) needs to have DC bypass capacitance (100pF/10nF/1uF) as close to the package as possible.

MTTF

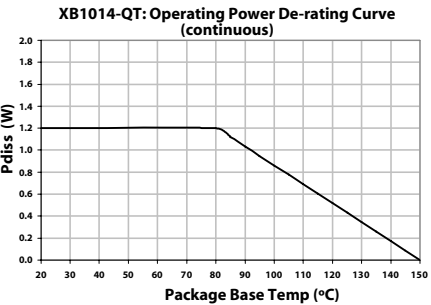
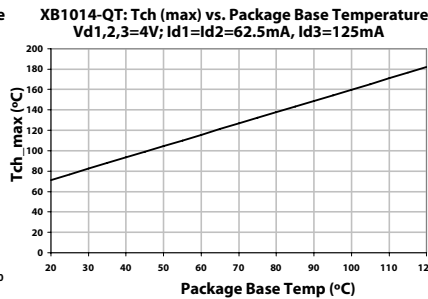
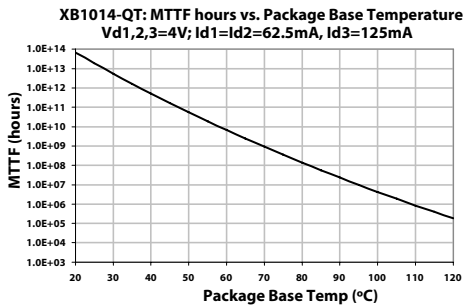

Typical Application

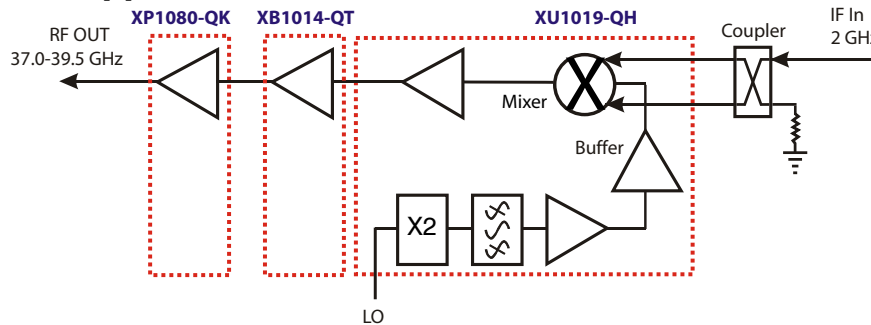

Mimix Broadband MMIC-based 37.0-40.0 GHz Transmitter Block Diagram

Factory Automation and Identification

Mimix Designator	Package Type	Number of leads offered	W Tape Width	P ₁ Component Pitch	P ₀ Hole Pitch	Reel Diameter	Units per Reel
-QT	QFN (3x3mm)	16	12mm	8mm	4mm	329mm (13in)	2000

Component Orientation: Parts are to be oriented with the PIN 1 closest to the tape's round sprocket holes on the tape's trailing edge.

Note: Tape and Reel packaging is ordered with a -000T suffix. Package is available in 500 unit reels through designated sales channels. Minimum order quantities should be discussed with your local sales representative.

37.0-40.0 GHz GaAs MMIC Buffer Amplifier, QFN

January 2011 - Rev 10-Jan-11

Handling and Assembly Information

CAUTION! - Mimix Broadband MMIC Products contain gallium arsenide (GaAs) which can be hazardous to the human body and the environment. For safety, observe the following procedures:

- Do not ingest.
- Do not alter the form of this product into a gas, powder, or liquid through burning, crushing, or chemical processing as these by-products are dangerous to the human body if inhaled, ingested, or swallowed.
- Observe government laws and company regulations when discarding this product. This product must be discarded in accordance with methods specified by applicable hazardous waste procedures.

Life Support Policy - Mimix Broadband's products are not authorized for use as critical components in life support devices or systems without the express written approval of the President and General Counsel of Mimix Broadband. As used herein: (1) Life support devices or systems are devices or systems which, (a) are intended for surgical implant into the body, or (b) support or sustain life, and whose failure to perform when properly used in accordance with instructions for use provided in the labeling, can be reasonably expected to result in a significant injury to the user. (2) A critical component is any component of a life support device or system whose failure to perform can be reasonably expected to cause the failure of the life support device or system, or to affect its safety or effectiveness.

Package Attachment - This packaged product from Mimix Broadband is provided as a rugged surface mount package compatible with high volume solder installation. Vacuum tools or other suitable pick and place equipment may be used to pick and place this part. Care should be taken to ensure that there are no voids or gaps in the solder connection so that good RF, DC and ground connections are maintained. Voids or gaps can eventually lead not only to RF performance degradation, but reduced reliability and life of the product due to thermal stress.

Typical Reflow Profiles

Reflow Profile	SnPb	Pb Free
Ramp Up Rate	3-4 °C/sec	3-4 °C/sec
Activation Time and Temperature	60-120 sec @ 140-160 °C	60-180 sec @ 170-200 °C
Time Above Melting Point	60-150 sec	60-150 sec
Max Peak Temperature	240 °C	265 °C
Time Within 5 °C of Peak	10-20 sec	10-20 sec
Ramp Down Rate	4-6 °C/sec	4-6 °C/sec

Factory Automation and Identification

Mimix Designator	Package Type	Number of leads offered	W Tape Width	P ₁ Component Pitch	P ₀ Hole Pitch	Reel Diameter	Units per Reel
-QT	QFN (3x3mm)	16	12mm	8mm	4mm	329mm (13in)	2000

Component Orientation: Parts are to be oriented with the PIN 1 closest to the tape's round sprocket holes on the tape's trailing edge.

Note: Tape and Reel packaging is ordered with a -0G0T suffix. Package is available in 500 unit reels through designated sales channels. Minimum order quantities should be discussed with your local sales representative.

Mimix Lead-Free RoHS Compliant Program - Mimix has an active program in place to meet customer and governmental requirements for eliminating lead (Pb) and other environmentally hazardous materials from our products. All Mimix RoHS compliant components are form, fit and functional replacements for their non-RoHS equivalents. Lead plating of our RoHS compliant parts is 100% matte tin (Sn) over copper alloy and is backwards compatible with current standard SnPb low-temperature reflow processes as well as higher temperature (260°C reflow) "Pb Free" processes.

Ordering Information

Part Number for Ordering

XB1014-QT-0G00
XB1014-QT-0G0T
XB1014-QT-EV1

Description

Matte Tin plated RoHS compliant 3x3 16L QFN surface mount package in bulk quantity
Matte Tin plated RoHS compliant 3x3 16L QFN surface mount package in tape and reel
XB1014-QT evaluation board



Caution: ESD Sensitive
Appropriate precautions in handling, packaging and testing devices must be observed.

Proper ESD procedures should be followed when handling this device.