

80V, 1.25A Peak Current H-Bridge FET Driver

The HIP4082 is a medium frequency, medium voltage H-Bridge N-Channel MOSFET driver IC, available in 16 lead plastic SOIC (N) and DIP packages.

Specifically targeted for PWM motor control and UPS applications, bridge based designs are made simple and flexible with the HIP4082 H-bridge driver. With operation up to 80V, the device is best suited to applications of moderate power levels.

Similar to the HIP4081, it has a flexible input protocol for driving every possible switch combination except those which would cause a shoot-through condition. The HIP4082's reduced drive current allows smaller packaging and it has a much wider range of programmable dead times (0.1 to 4.5 μ s) making it ideal for switching frequencies up to 200kHz. The HIP4082 does not contain an internal charge pump, but does incorporate non-latching level-shift translation control of the upper drive circuits.

This set of features and specifications is optimized for applications where size and cost are important. For applications needing higher drive capability the HIP4080A and HIP4081A are recommended.

Features

- Independently Drives 4 N-Channel FET in Half Bridge or Full Bridge Configurations
- Bootstrap Supply Max Voltage to 95VDC
- Drives 1000pF Load in Free Air at 50°C with Rise and Fall Times of Typically 15ns
- User-Programmable Dead Time (0.1 to 4.5 μ s)
- DIS (Disable) Overrides Input Control and Refreshes Bootstrap Capacitor when Pulled Low
- Input Logic Thresholds Compatible with 5V to 15V Logic Levels
- Shoot-Through Protection
- Undervoltage Protection
- Pb-Free Plus Anneal Available (RoHS Compliant)

Applications

- UPS Systems
- DC Motor Controls
- Full Bridge Power Supplies
- Switching Power Amplifiers
- Noise Cancellation Systems
- Battery Powered Vehicles
- Peripherals
- Medium/Large Voice Coil Motors
- Related Literature
 - TB363, Guidelines for Handling and Processing Moisture Sensitive Surface Mount Devices (SMDs)

HIP4082

Ordering Information

PART NUMBER	PART MARKING	TEMP. RANGE (°C)	PACKAGE	PKG. DWG. #
HIP4082IB*	HIP4082IB	-55 to +125	16 Ld SOIC (N)	M16.15
HIP4082IBZ* (Note)	4082IBZ	-55 to +125	16 Ld SOIC (N) (Pb-free)	M16.15
HIP4082IP (No longer available, recommended replacement: HIP4082IPZ)	HIP4082IP	-55 to +125	16 Ld PDIP	E16.3
HIP4082IPZ (Note)	HIP4082IPZ	-55 to +125	16 Ld PDIP** (Pb-free)	E16.3

*Add "T" suffix for tape and reel.

NOTE: Intersil Pb-free plus anneal products employ special Pb-free material sets; molding compounds/die attach materials and 100% matte tin plate termination finish, which are RoHS compliant and compatible with both SnPb and Pb-free soldering operations. Intersil Pb-free products are MSL classified at Pb-free peak reflow temperatures that meet or exceed the Pb-free requirements of IPC/JEDEC J STD-020.

**Pb-free PDIPs can be used for through hole wave solder processing only. They are not intended for use in Reflow solder processing applications.

Pinout

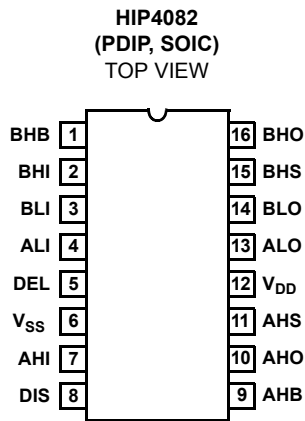

Application Block Diagram

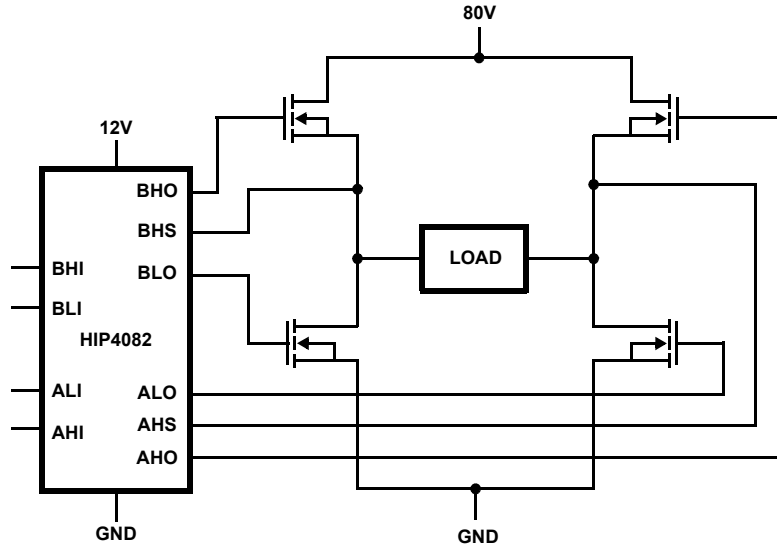

Functional Block Diagram

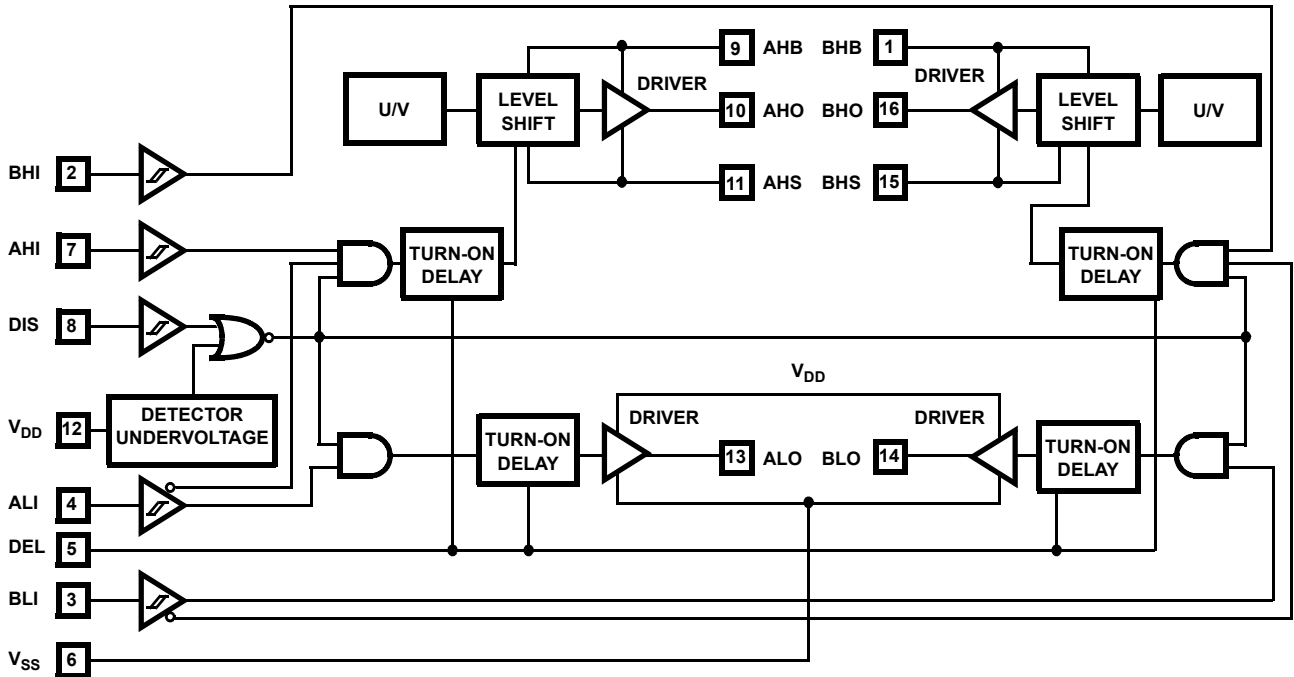

Typical Application (PWM Mode Switching)

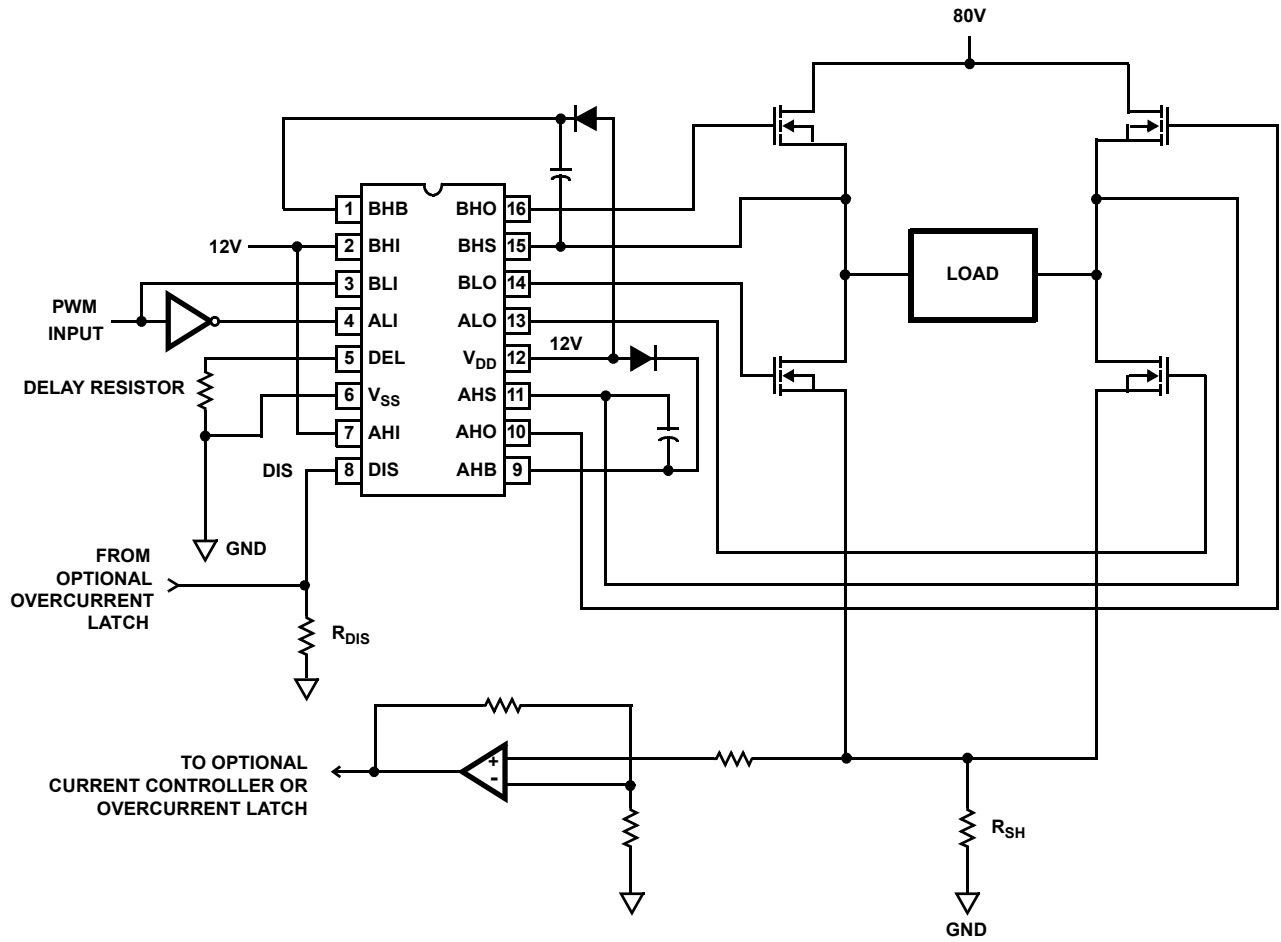

Absolute Maximum Ratings

Supply Voltage, V_{DD} -0.3V to 16V
 Logic I/O Voltages -0.3V to $V_{DD} + 0.3V$
 Voltage on AHS, BHS -6V (Transient) to 80V (25°C to 150°C)
 Voltage on AHS, BHS -6V (Transient) to 70V (-55°C to 150°C)
 Voltage on AHB, BHB $V_{AHS, BHS} - 0.3V$ to $V_{AHS, BHS} + V_{DD}$
 Voltage on ALO, BLO $V_{SS} - 0.3V$ to $V_{DD} + 0.3V$
 Voltage on AHO, BHO $V_{AHS, BHS} - 0.3V$ to $V_{AHB, BHB} + 0.3V$ Input
 Current, DEL -5mA to 0mA
 Phase Slew Rate 20V/ns
 NOTE: All voltages are relative V_{SS} unless otherwise specified.

Thermal Information

Thermal Resistance θ_{JA} (°C/W)
 SOIC Package 115
 DIP Package 90
 Maximum Power Dissipation See Curve
 Storage Temperature Range -65°C to +150°C
 Operating Max. Junction Temperature +150°C
 Lead Temperature (Soldering 10s) +300°C
 (For SOIC - Lead Tips Only)

Operating Conditions

Supply Voltage, V_{DD} +8.5V to +15V
 Voltage on V_{SS} -1.0V to +1.0V
 Voltage on AHB, BHB $V_{AHS, BHS} + 7.5V$ to $V_{AHS, BHS} + V_{DD}$
 Input Current, DEL -4mA to -100µA

CAUTION: Stresses above those listed in "Absolute Maximum Ratings" may cause permanent damage to the device. This is a stress only rating and operation of the device at these or any other conditions above those indicated in the operational sections of this specification is not implied.

Electrical Specifications $V_{DD} = V_{AHB} = V_{BHB} = 12V, V_{SS} = V_{AHS} = V_{BHS} = 0V, R_{DEL} = 100K$

PARAMETER	SYMBOL	TEST CONDITIONS	$T_J = +25^\circ C$			$T_J = -55^\circ C$ TO $+150^\circ C$		UNITS
			MIN	TYP	MAX	MIN	MAX	
SUPPLY CURRENTS & UNDER VOLTAGE PROTECTION								
V_{DD} Quiescent Current	I_{DD}	All inputs = 0V, $R_{DEL} = 100K$	1.2	2.3	3.5	0.85	4	mA
		All inputs = 0V, $R_{DEL} = 10K$	2.2	4.0	5.5	1.9	6.0	mA
V_{DD} Operating Current	I_{DDO}	f = 50kHz, no load	1.5	2.6	4.0	1.1	4.2	mA
		50kHz, no load, $R_{DEL} = 10k\Omega$	2.5	4.0	6.4	2.1	6.6	mA
AHB, BHB Off Quiescent Current	I_{AHBL}, I_{BHBL}	AHI = BHI = 0V	0.5	1.0	1.5	0.4	1.6	mA
AHB, BHB On Quiescent Current	I_{AHBH}, I_{BHBH}	AHI = BHI = V_{DD}	65	145	240	40	250	µA
AHB, BHB Operating Current	I_{AHBO}, I_{BHBO}	f = 50kHz, CL = 1000pF	.65	1.1	1.8	.45	2.0	mA
AHS, BHS Leakage Current	I_{HLK}	$V_{AHS} = V_{BHS} = 80V$ $V_{AHB} = V_{BHB} = 96$ $V_{DD} =$ Not Connected	-	-	1.0	-	-	µA
V_{DD} Rising Undervoltage Threshold	V_{DDUV+}		6.8	7.6	8.25	6.5	8.5	V
V_{DD} Falling Undervoltage Threshold	V_{DDUV-}		6.5	7.1	7.8	6.25	8.1	V
Undervoltage Hysteresis	UVHYS		0.17	0.4	0.75	0.15	0.90	V
AHB, BHB Undervoltage Threshold	VHBUV	Referenced to AHS & BHS	5	6.0	7	4.5	7.5	V
INPUT PINS: ALI, BLI, AHI, BHI, & DIS								
Low Level Input Voltage	V_{IL}	Full Operating Conditions	-	-	1.0	-	0.8	V
High Level Input Voltage	V_{IH}	Full Operating Conditions	2.5	-	-	2.7	-	V
Input Voltage Hysteresis			-	35	-	-	-	mV
Low Level Input Current	I_{IL}	$V_{IN} = 0V$, Full Operating Conditions	-145	-100	-60	-150	-50	µA
High Level Input Current	I_{IH}	$V_{IN} = 5V$, Full Operating Conditions	-1	-	+1	-10	+10	µA
TURN-ON DELAY PIN DEL								
Dead Time	T_{DEAD}	$R_{DEL} = 100K$	2.5	4.5	8.0	2.0	8.5	µs
		$R_{DEL} = 10K$	0.27	0.5	0.75	0.2	0.85	µs

HIP4082

Electrical Specifications $V_{DD} = V_{AHB} = V_{BHB} = 12V, V_{SS} = V_{AHS} = V_{BHS} = 0V, R_{DEL} = 100K$ (Continued)

PARAMETER	SYMBOL	TEST CONDITIONS	$T_J = +25^\circ C$			$T_J = -55^\circ C$ TO $+150^\circ C$		UNITS
			MIN	TYP	MAX	MIN	MAX	
GATE DRIVER OUTPUT PINS: ALO, BLO, AHO, & BHO								
Low Level Output Voltage	V_{OL}	$I_{OUT} = 50mA$	0.65		1.1	0.5	1.2	V
High Level Output Voltage	$V_{DD}-V_{OH}$	$I_{OUT} = -50mA$	0.7		1.2	0.5	1.3	V
Peak Pullup Current	I_{O+}	$V_{OUT} = 0V$	1.1	1.4	2.5	0.85	2.75	A
Peak Pulldown Current	I_{O-}	$V_{OUT} = 12V$	1.0	1.3	2.3	0.75	2.5	A

Switching Specifications $V_{DD} = V_{AHB} = V_{BHB} = 12V, V_{SS} = V_{AHS} = V_{BHS} = 0V, R_{DEL} = 100K, C_L = 1000pF$

PARAMETER	SYMBOL	TEST CONDITIONS	$T_J = +25^\circ C$			$T_J = -55^\circ C$ TO $+150^\circ C$		UNITS
			MIN	TYP	MAX	MIN	MAX	
Lower Turn-off Propagation Delay (ALI-ALO, BLI-BLO)	T_{LPHL}		-	25	50	-	70	ns
Upper Turn-off Propagation Delay (AHI-AHO, BHI-BHO)	T_{HPHL}		-	55	80	-	100	ns
Lower Turn-on Propagation Delay (ALI-ALO, BLI-BLO)	T_{LPLH}		-	40	85	-	100	ns
Upper Turn-on Propagation Delay (AHI-AHO, BHI-BHO)	T_{HPLH}		-	75	110	-	150	ns
Rise Time	T_R		-	9	20	-	25	ns
Fall Time	T_F		-	9	20	-	25	ns
Minimum Input Pulse Width	$T_{PWIN-ON/OFF}$		50	-	-	50	-	ns
Output Pulse Response to 50 ns Input Pulse	T_{PWOUT}			63			80	ns
Disable Turn-off Propagation Delay (DIS - Lower Outputs)	T_{DISLOW}		-	50	80	-	90	ns
Disable Turn-off Propagation Delay (DIS - Upper Outputs)	$T_{DISHIGH}$		-	75	100	-	125	ns
Disable Turn-on Propagation Delay (DIS - ALO & BLO)	T_{DLPLH}		-	40	70	-	100	ns
Disable Turn-on Propagation Delay (DIS- AHO & BHO)	T_{DHPLH}	$R_{DEL} = 10K$	-	1.2	2	-	3	μs
Refresh Pulse Width (ALO & BLO)	T_{REF-PW}		375	580	900	350	950	ns

TRUTH TABLE

INPUT					OUTPUT	
ALI, BLI	AHI, BHI	VDDUV	VHBUV	DIS	ALO, BLO	AHO, BHO
X	X	X	X	1	0	0
X	X	1	X	X	0	0
0	X	0	1	0	0	0
1	X	0	X	0	1	0
0	1	0	0	0	0	1
0	0	0	0	0	0	0

NOTE: X signifies that input can be either a "1" or "0".

Pin Descriptions

PIN NUMBER	SYMBOL	DESCRIPTION
1	BHB	B High-side Bootstrap supply. External bootstrap diode and capacitor are required. Connect cathode of bootstrap diode and positive side of bootstrap capacitor to this pin.
2	BHI	B High-side Input. Logic level input that controls BHO driver (Pin 16). BLI (Pin 3) high level input overrides BHI high level input to prevent half-bridge shoot-through, see Truth Table. DIS (Pin 8) high level input overrides BHI high level input. The pin can be driven by signal levels of 0V to 15V (no greater than V_{DD}).
3	BLI	B Low-side Input. Logic level input that controls BLO driver (Pin 14). If BHI (Pin 2) is driven high or not connected externally then BLI controls both BLO and BHO drivers, with dead time set by delay currents at DEL (Pin 5). DIS (Pin 8) high level input overrides BLI high level input. The pin can be driven by signal levels of 0V to 15V (no greater than V_{DD}).
4	ALI	A Low-side Input. Logic level input that controls ALO driver (Pin 13). If AHI (Pin 7) is driven high or not connected externally then ALI controls both ALO and AHO drivers, with dead time set by delay currents at DEL (Pin 5). DIS (Pin 8) high level input overrides ALI high level input. The pin can be driven by signal levels of 0V to 15V (no greater than V_{DD}).
5	DEL	Turn-on DELay. Connect resistor from this pin to V_{SS} to set timing current that defines the dead time between drivers. All drivers turn-off with no adjustable delay, so the DEL resistor guarantees no shoot-through by delaying the turn-on of all drivers. The voltage across the DEL resistor is approximately $V_{DD} - 2V$.
6	V_{SS}	Chip negative supply, generally will be ground.
7	AHI	A High-side Input. Logic level input that controls AHO driver (Pin 10). ALI (Pin 4) high level input overrides AHI high level input to prevent half-bridge shoot-through, see Truth Table. DIS (Pin 8) high level input overrides AHI high level input. The pin can be driven by signal levels of 0V to 15V (no greater than V_{DD}).
8	DIS	DISable input. Logic level input that when taken high sets all four outputs low. DIS high overrides all other inputs. When DIS is taken low the outputs are controlled by the other inputs. The pin can be driven by signal levels of 0V to 15V (no greater than V_{DD}).
9	AHB	A High-side Bootstrap supply. External bootstrap diode and capacitor are required. Connect cathode of bootstrap diode and positive side of bootstrap capacitor to this pin.
10	AHO	A High-side Output. Connect to gate of A High-side power MOSFET.
11	AHS	A High-side Source connection. Connect to source of A High-side power MOSFET. Connect negative side of bootstrap capacitor to this pin.
12	V_{DD}	Positive supply to control logic and lower gate drivers. De-couple this pin to V_{SS} (Pin 6).
13	ALO	A Low-side Output. Connect to gate of A Low-side power MOSFET.
14	BLO	B Low-side Output. Connect to gate of B Low-side power MOSFET.
15	BHS	B High-side Source connection. Connect to source of B High-side power MOSFET. Connect negative side of bootstrap capacitor to this pin.
16	BHO	B High-side Output. Connect to gate of B High-side power MOSFET.

Timing Diagrams

X = A OR B, A AND B HALVES OF BRIDGE CONTROLLER ARE INDEPENDENT

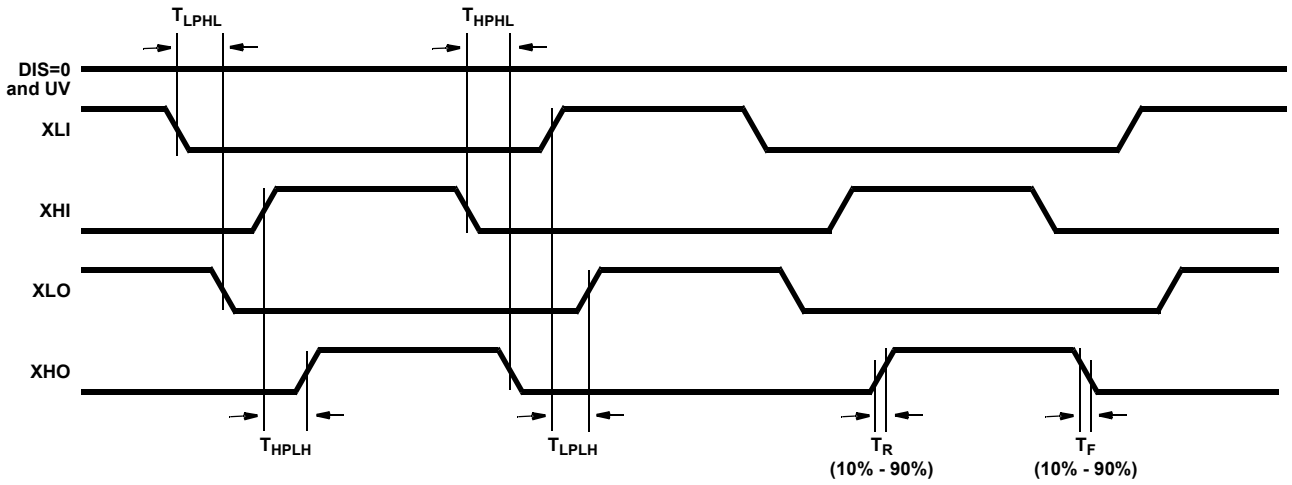

FIGURE 1. INDEPENDENT MODE

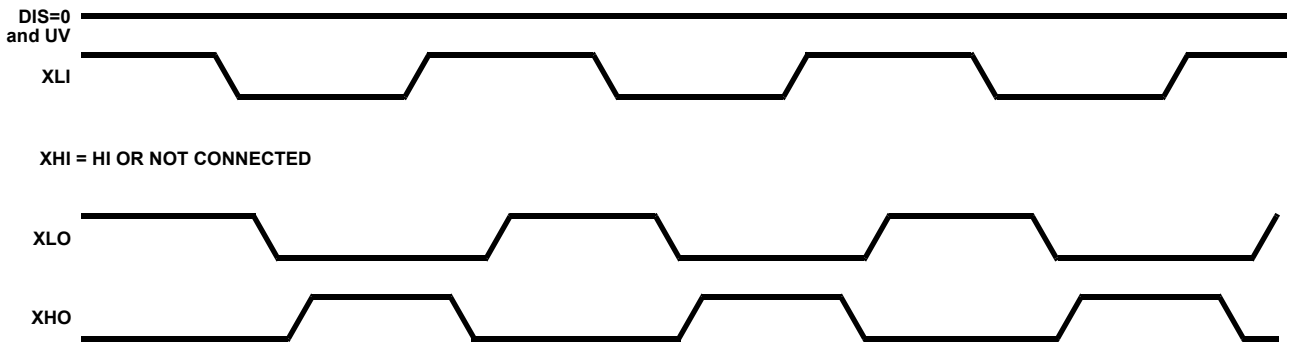

FIGURE 2. BISTATE MODE

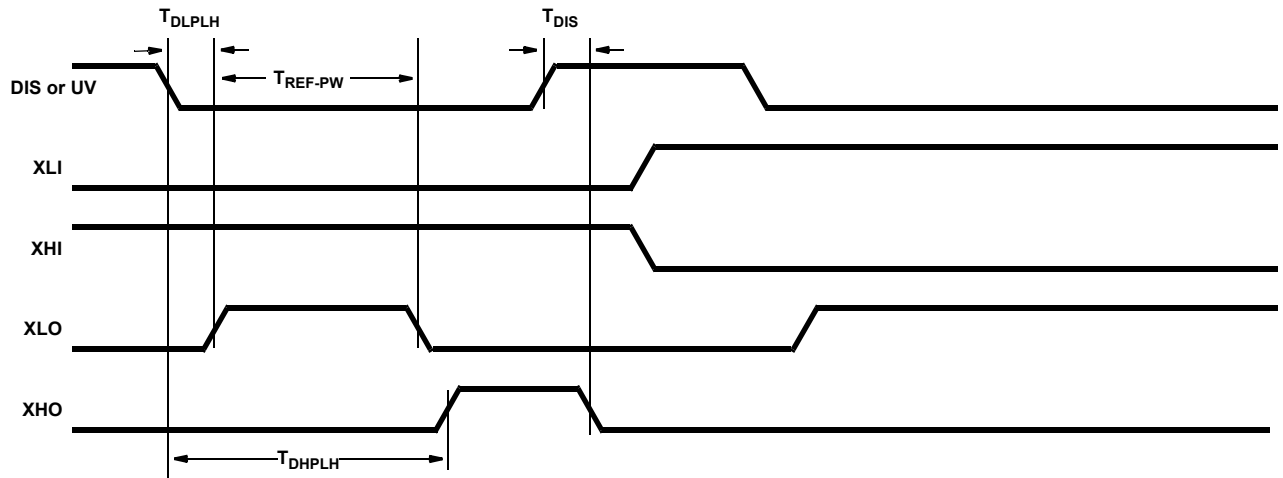

FIGURE 3. DISABLE FUNCTION

Performance Curves

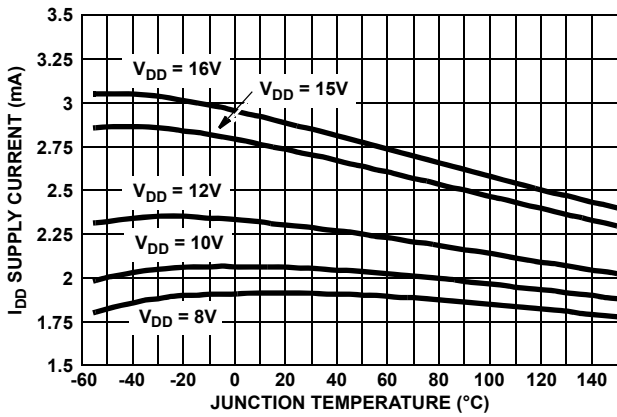

FIGURE 4. I_{DD} SUPPLY CURRENT vs TEMPERATURE AND V_{DD} SUPPLY VOLTAGE

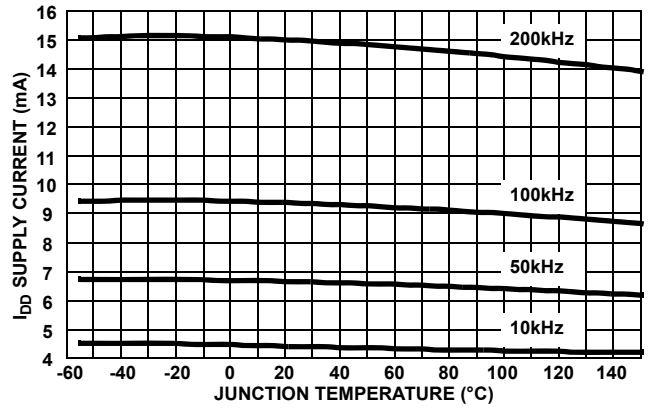

FIGURE 5. V_{DD} SUPPLY CURRENT vs TEMPERATURE AND SWITCHING FREQUENCY (1000pF LOAD)

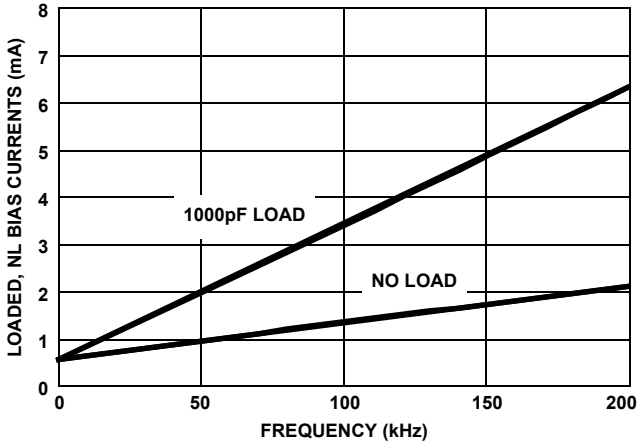

FIGURE 6. FLOATING (IXHB) BIAS CURRENT vs FREQUENCY AND LOAD

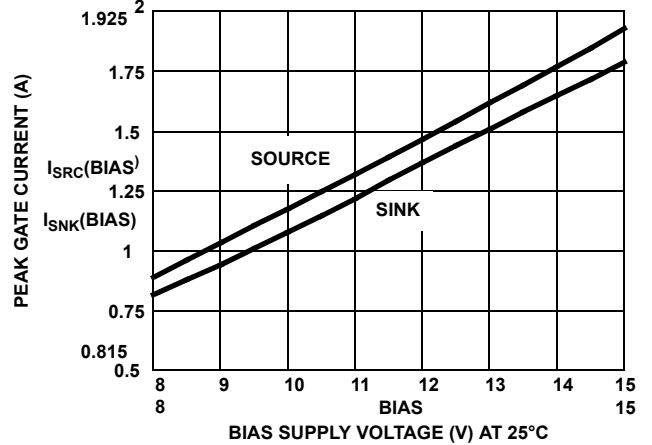

FIGURE 7. GATE SOURCE/SINK PEAK CURRENT vs BIAS SUPPLY VOLTAGE AT 25°C

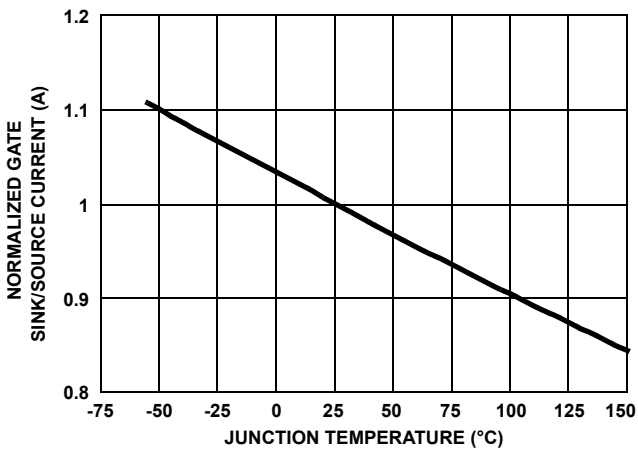

FIGURE 8. GATE CURRENT vs TEMPERATURE, NORMALIZED TO 25°C

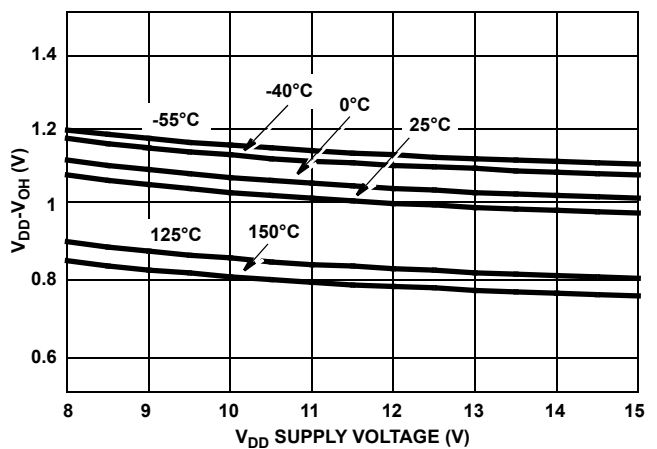

FIGURE 9. $V_{DD}-V_{OH}$ vs BIAS VOLTAGE TEMPERATURE

Performance Curves (Continued)

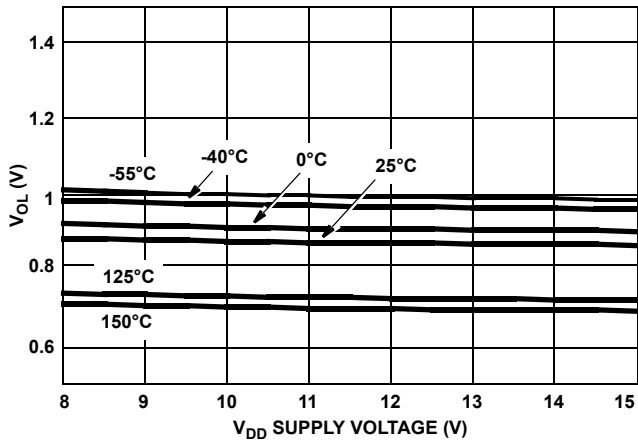

FIGURE 10. V_{OL} vs BIAS VOLTAGE AND TEMPERATURE

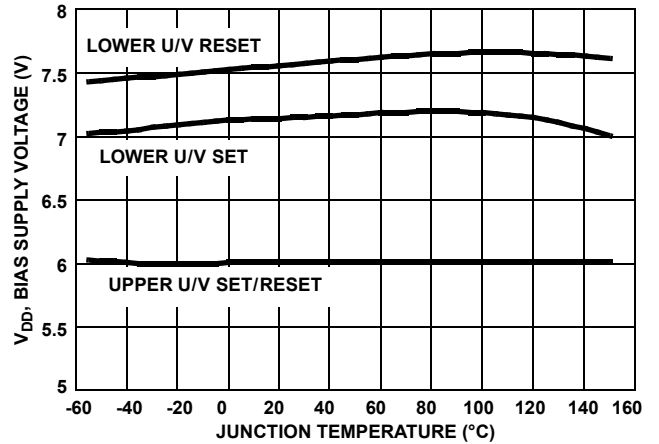

FIGURE 11. UNDERVOLTAGE TRIP VOLTAGES vs TEMPERATURE

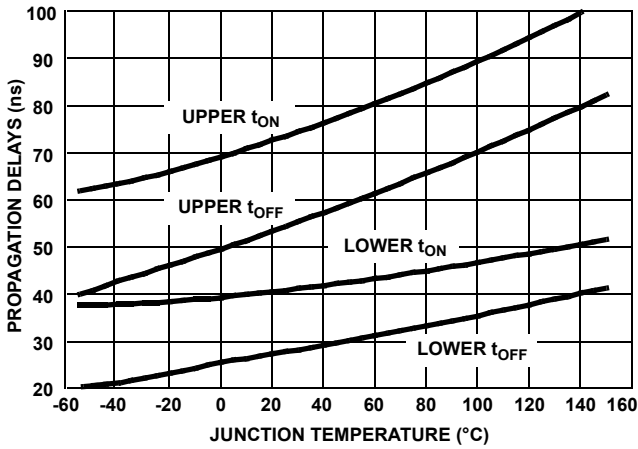

FIGURE 12. UPPER LOWER TURN-ON/TURN-OFF PROPAGATION DELAY vs TEMPERATURE

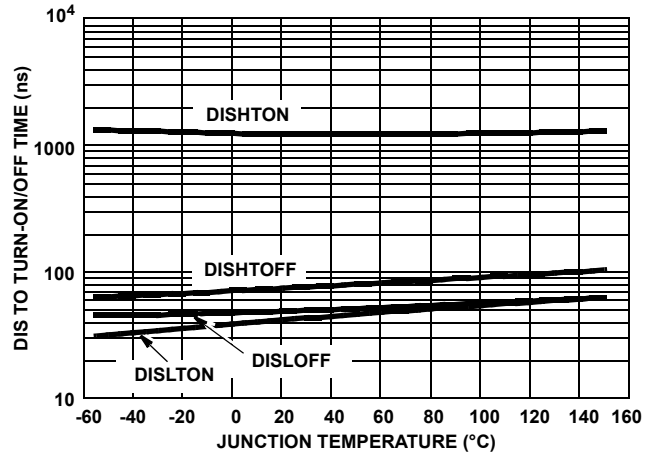

FIGURE 13. UPPER/LOWER DIS(ABLE) TO TURN-ON/OFF vs TEMPERATURE (°C)

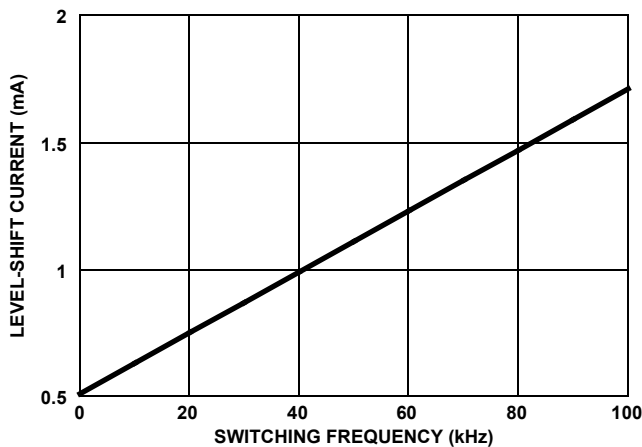

FIGURE 14. FULL BRIDGE LEVEL-SHIFT CURRENT vs FREQUENCY (kHz)

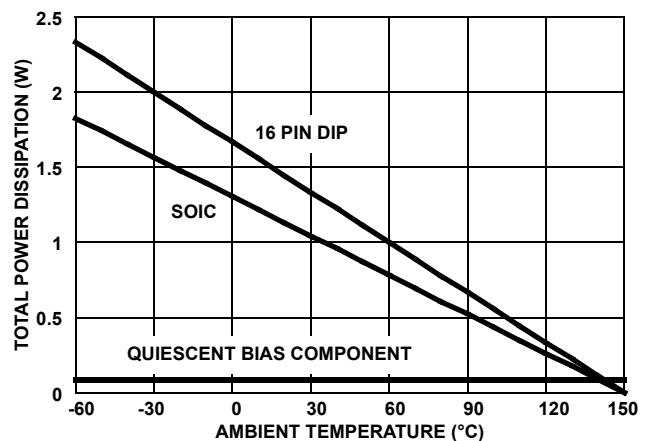

FIGURE 15. MAXIMUM POWER DISSIPATION vs AMBIENT TEMPERATURE

Performance Curves (Continued)

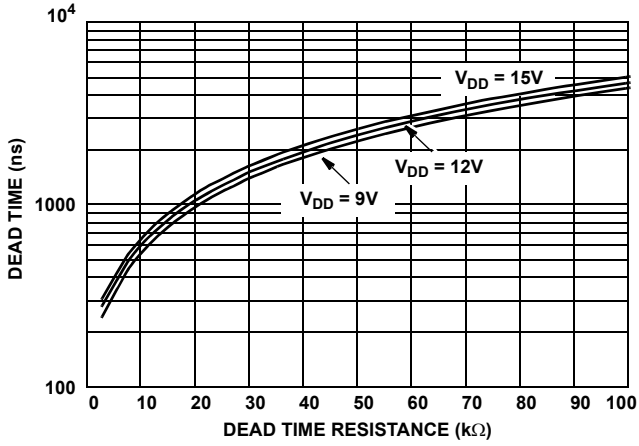

FIGURE 16. DEAD-TIME vs DEL RESISTANCE AND BIAS SUPPLY (V_{DD}) VOLTAGE

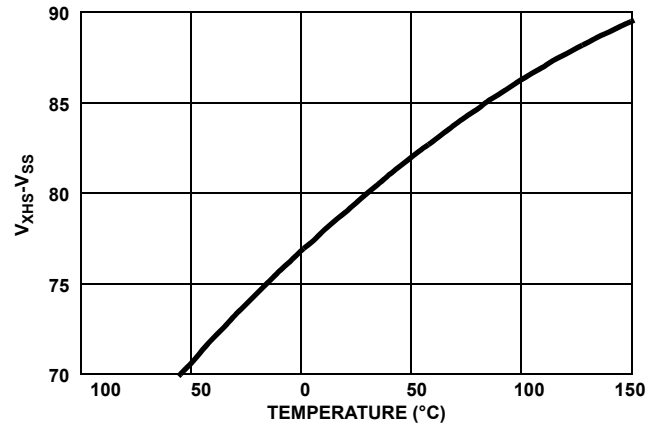

FIGURE 17. MAXIMUM OPERATING PEAK AHS/BHS VOLTAGE vs TEMPERATURE

Revision History

The revision history provided is for informational purposes only and is believed to be accurate, but not warranted. Please go to the web to make sure that you have the latest revision.

DATE	REVISION	CHANGE
September 30, 2015	FN3676.5	Updated the Ordering Information Table on page 2. Added Revision History and About Intersil sections.

About Intersil

Intersil Corporation is a leading provider of innovative power management and precision analog solutions. The company's products address some of the largest markets within the industrial and infrastructure, mobile computing and high-end consumer markets.

For the most updated datasheet, application notes, related documentation and related parts, please see the respective product information page found at www.intersil.com.

You may report errors or suggestions for improving this datasheet by visiting www.intersil.com/ask.

Reliability reports are also available from our website at www.intersil.com/support.

Dual-In-Line Plastic Packages (PDIP)

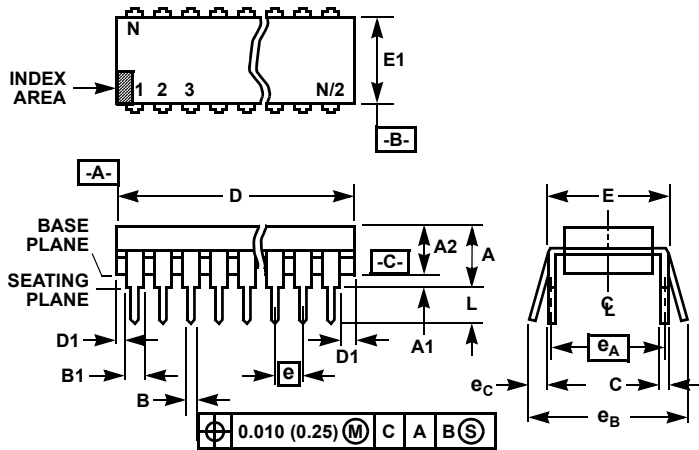

NOTES:

- Controlling Dimensions: INCH. In case of conflict between English and Metric dimensions, the inch dimensions control.
- Dimensioning and tolerancing per ANSI Y14.5M-1982.
- Symbols are defined in the "MO Series Symbol List" in Section 2.2 of Publication No. 95.
- Dimensions A, A1 and L are measured with the package seated in JEDEC seating plane gauge GS-3.
- D, D1, and E1 dimensions do not include mold flash or protrusions. Mold flash or protrusions shall not exceed 0.010 inch (0.25mm).
- E and e_A are measured with the leads constrained to be perpendicular to datum $-C-$.
- e_B and e_C are measured at the lead tips with the leads unconstrained. e_C must be zero or greater.
- B1 maximum dimensions do not include dambar protrusions. Dambar protrusions shall not exceed 0.010 inch (0.25mm).
- N is the maximum number of terminal positions.
- Corner leads (1, N, N/2 and N/2 + 1) for E8.3, E16.3, E18.3, E28.3, E42.6 will have a B1 dimension of 0.030 - 0.045 inch (0.76 - 1.14mm).

E16.3 (JEDEC MS-001-BB ISSUE D)
16 LEAD DUAL-IN-LINE PLASTIC PACKAGE

SYMBOL	INCHES		MILLIMETERS		NOTES
	MIN	MAX	MIN	MAX	
A	-	0.210	-	5.33	4
A1	0.015	-	0.39	-	4
A2	0.115	0.195	2.93	4.95	-
B	0.014	0.022	0.356	0.558	-
B1	0.045	0.070	1.15	1.77	8, 10
C	0.008	0.014	0.204	0.355	-
D	0.735	0.775	18.66	19.68	5
D1	0.005	-	0.13	-	5
E	0.300	0.325	7.62	8.25	6
E1	0.240	0.280	6.10	7.11	5
e	0.100 BSC		2.54 BSC		-
e_A	0.300 BSC		7.62 BSC		6
e_B	-	0.430	-	10.92	7
L	0.115	0.150	2.93	3.81	4
N	16		16		9

Rev. 0 12/93

Small Outline Plastic Packages (SOIC)

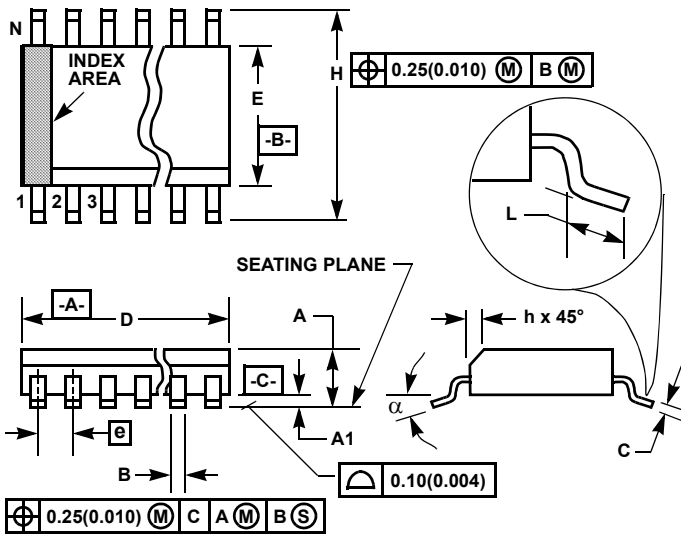

M16.15 (JEDEC MS-012-AC ISSUE C)
16 LEAD NARROW BODY SMALL OUTLINE PLASTIC PACKAGE

SYMBOL	INCHES		MILLIMETERS		NOTES
	MIN	MAX	MIN	MAX	
A	0.0532	0.0688	1.35	1.75	-
A1	0.0040	0.0098	0.10	0.25	-
B	0.013	0.020	0.33	0.51	9
C	0.0075	0.0098	0.19	0.25	-
D	0.3859	0.3937	9.80	10.00	3
E	0.1497	0.1574	3.80	4.00	4
e	0.050 BSC		1.27 BSC		-
H	0.2284	0.2440	5.80	6.20	-
h	0.0099	0.0196	0.25	0.50	5
L	0.016	0.050	0.40	1.27	6
N	16		16		7
α	0°	8°	0°	8°	-

NOTES:

1. Symbols are defined in the "MO Series Symbol List" in Section 2.2 of Publication Number 95.
2. Dimensioning and tolerancing per ANSI Y14.5M-1982.
3. Dimension "D" does not include mold flash, protrusions or gate burrs. Mold flash, protrusion and gate burrs shall not exceed 0.15mm (0.006 inch) per side.
4. Dimension "E" does not include interlead flash or protrusions. Interlead flash and protrusions shall not exceed 0.25mm (0.010 inch) per side.
5. The chamfer on the body is optional. If it is not present, a visual index feature must be located within the crosshatched area.
6. "L" is the length of terminal for soldering to a substrate.
7. "N" is the number of terminal positions.
8. Terminal numbers are shown for reference only.
9. The lead width "B", as measured 0.36mm (0.014 inch) or greater above the seating plane, shall not exceed a maximum value of 0.61mm (0.024 inch).
10. Controlling dimension: MILLIMETER. Converted inch dimensions are not necessarily exact.

Rev. 1 6/05

For additional products, see www.intersil.com/en/products.html

Intersil products are manufactured, assembled and tested utilizing ISO9001 quality systems as noted in the quality certifications found at www.intersil.com/en/support/qualandreliability.html

Intersil products are sold by description only. Intersil Corporation reserves the right to make changes in circuit design, software and/or specifications at any time without notice. Accordingly, the reader is cautioned to verify that data sheets are current before placing orders. Information furnished by Intersil is believed to be accurate and reliable. However, no responsibility is assumed by Intersil or its subsidiaries for its use; nor for any infringements of patents or other rights of third parties which may result from its use. No license is granted by implication or otherwise under any patent or patent rights of Intersil or its subsidiaries.

For information regarding Intersil Corporation and its products, see www.intersil.com