

CBM-120

Mosaic Array Series

Far Red Chip On Board LEDs



Table of Contents

Technology Overview	2
Binning Structure	3
Ordering Information	4
Optical & Electrical Characteristics	5
Thermal Resistance	8
Electrical Pinout	8
Mechanical Dimensions	9
Packaging Information	10
Revision History	12

Features:

- Mosaic Array Far Red LED chipset with surface emitting area of 12 mm², 4:3 aspect ratio
- Vertical chip LED technology for high power density and uniform emission
- High thermal conductivity copper coreboard package
- Can be operated at variable drive currents up to 18A

Applications:

- Inspection
- Machine Vision
- Fiber-coupled illumination
- Medical and Scientific Instrumentation

Technology Overview

Luminus LEDs benefit from innovations in device technology, chip packaging and thermal management. This suite of technologies give engineers and system designers the freedom to develop solutions both high in power and efficiency.

Luminus Mosaic Array LED Technology

Luminus' Devices vertical chip technology enables LED chips with uniform brightness over the entire chip surface. The optical power and brightness produced by these densely packed arrays of devices enable solutions not possible with single chip packages that be used to replace arc and halogen lamps.

Packaging Technology

Thermal management is critical in high power LED applications. With a thermal resistance from junction to board of 0.64 °C/W, Luminus CBM-120 LEDs have the lowest thermal resistance of any packaged LED on the market. This will allow the LEDs to be driven at higher current densities while maintaining a low junction temperature, thereby resulting in brighter solutions and longer lifetimes.

Reliability

With designs based on years of chip and packaging development experience, Luminus LEDs are one of the most reliable light sources in the world today. Luminus LEDs pass a rigorous suite of environmental and mechanical stress tests, including mechanical shock, vibration, temperature cycling and humidity, and have been fully qualified for use in extreme high power and high current applications.

Environmental Benefits

Luminus LEDs help reduce power consumption and the amount of hazardous waste entering the environment. All LED products manufactured by Luminus are RoHS and Halogen compliant and free of hazardous materials, including lead and mercury.

Understanding Mosaic Array LED Test Specifications

Every Luminus LED is fully tested to ensure that it meets the high quality standards expected from Luminus' products.

Testing Temperature

Luminus core board products are typically measured in such a way that the characteristics reported agree with how the devices will actually perform when incorporated into a system.

This method of measurement ensures that Luminus LEDs perform in the field just as they are specified.

Multiple Operating Points

The tables on the following pages provide typical optical and electrical characteristics for the standard drive conditions. Since the LEDs can be operated over a wide range of drive conditions and duty cycles from <1% to 100% there are many other potential values attainable. Driving devices beyond recommended driving conditions shortens lifetime.

CBM-120-FR Binning Structure

All CBM-120-FR LEDs are tested for radiometric power / peak wavelength and placed into one of the following flux / wavelength bins.

Color	Radiometric Power Bin (FF)	Min Radiometric Power (Watts) @ 9A	Max Radiometric Power (Watts) @ 9A
Far Red (Radiometric Power)	RA	4.6	5.8
	RB	5.8	7.0
	RC	7.0	8.2

Note: Luminus maintains a +/-6% tolerance in Flux measurements.

Color	Peak Wavelength Bin	Min Peak Wavelength @ 9A	Max Peak Wavelength @ 9A
Far Red (Peak Wavelength)	P720	720	725
	P725	725	730
	P730	730	735
	P735	735	740

Note: Luminus maintains a +/-1nm tolerance in Peak Wavelength measurements.

Ordering Information

Products	Ordering Part Number	Description
CBM-120-FR	CBM-120-FR-C15-FF###	CBM-120 Mosaic Array chipset consisting of 12x1mm ² Far Red LEDs, a thermistor, connectors, and a square copper-core PCB.

Part Number Nomenclature

CBM — 120 — CC — C## — FF###

Product Family	Chip Area	Color	Package Configuration	Bin Kit ^{1,2}
CBM: Copper-core PCB, Multi Chip Array, No Encapsulation	120: 12 mm ²	FR= Far Red	C15: 28 mm x 26.75 mm - Common Anode Package See Mechanical Drawing section	See page 3 for complete bin definition table

Note 1: A Bin Kit represents a group of individual flux or power bins that are shippable for a given ordering part number. Individual flux bins are not orderable.

Note 2: Flux Bin listed is minimum bin shipped - higher bins may be included at Luminus' discretion

CBM-120-FR Orderable Bin Kits

Color	Radiometric Power			Peak Wavelength Bins	Kit Number
	Min. Flux Bin	Min Power	Max Power		
Far Red	RA	4.6W	8.2W	P730, P735	RA100
				P720, P725, P730, P735	RA200

Reference Optical & Electrical Characteristics ($T_{hs} = 40^{\circ}\text{C}$)

FAR RED			
Parameter	Symbol	Values ¹	Unit
Drive Conditions ²	I	9	A
Peak Wavelength Typ.	λ_p	730	nm
Current Density	j	0.75	A/mm ²
Forward Voltage	V_{Fmin}	2.0	V
	V_F	2.2	V
	V_{Fmax}	2.8	V
Radiometric Flux	Φ_{typ}	6.3	W
FWHM- Spectral bandwidth at 50% of Φ_v ³		32	nm

Parameter	Symbol	Values	Unit
Absolute Minimum Current (CW or Pulsed) ³		0.2	A
Absolute Maximum Current (CW) ⁴		18.0	A
Maximum Junction Temperature ⁵	T_{jmax}	110	°C
Storage Temperature Range		-40 to +100	°C
Emitting Area Dimensions		4.4 × 3.3	mm × mm

Note 1: Unless otherwise noted, values listed are typical. Devices are production tested and specified at 9 A.

Note 2: Listed drive conditions are typical for common applications. CBM120-FR devices can be driven at currents ranging from 200 mA to 18 A and at duty cycles ranging from 1% to 100%. Drive current and duty cycle should be adjusted as necessary to maintain the junction temperature desired to meet application lifetime requirements.

Note 3: Special design considerations must be observed for operation under 1 A. Please contact Luminus for further information.

Note 4: CBM-120-FR LEDs are designed for operation to an absolute maximum current as specified above. Sustained operation at or beyond absolute maximum currents will result in a reduction of device life time compared to recommended forward drive currents. Actual device lifetimes will also depend on junction temperature. In pulsed operation, rise time from 10-90% of forward current should be longer than 0.5 μ seconds.

Note 5: Lifetime dependent on LED junction temperature. Input power and thermal system must be properly managed to ensure lifetime.

Optical & Electrical Characteristics

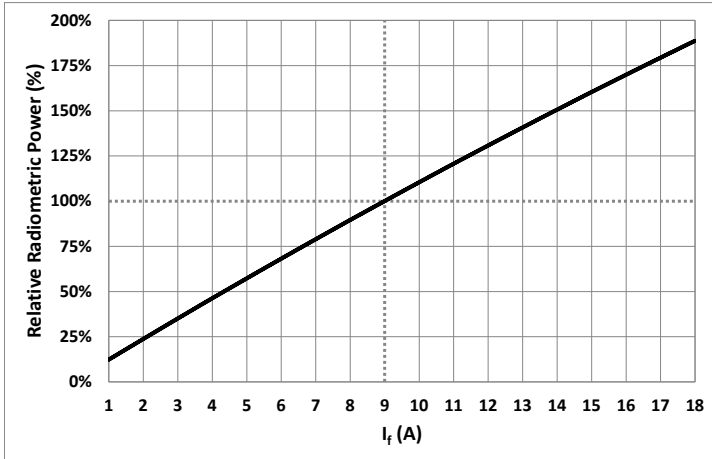
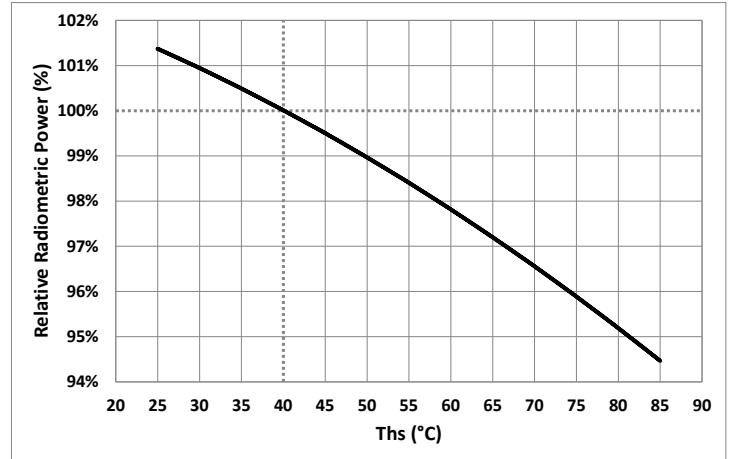
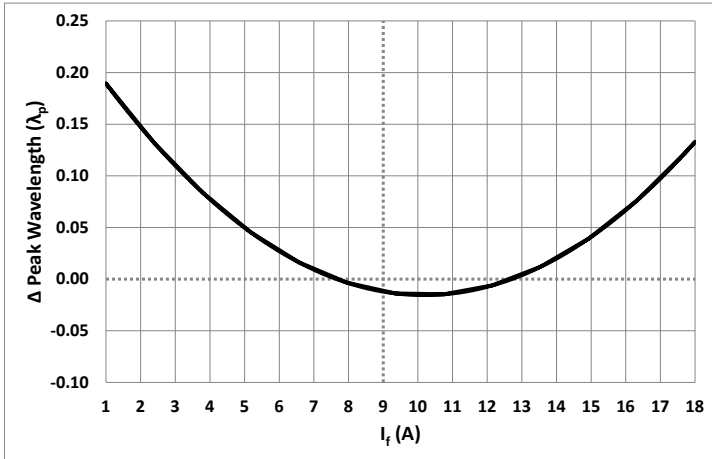
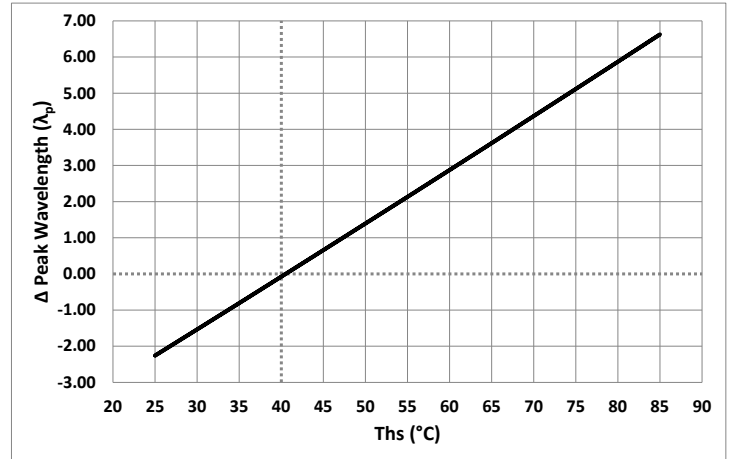
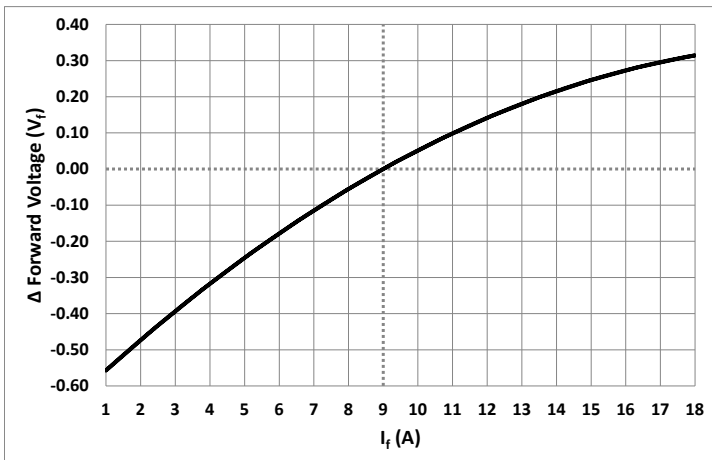
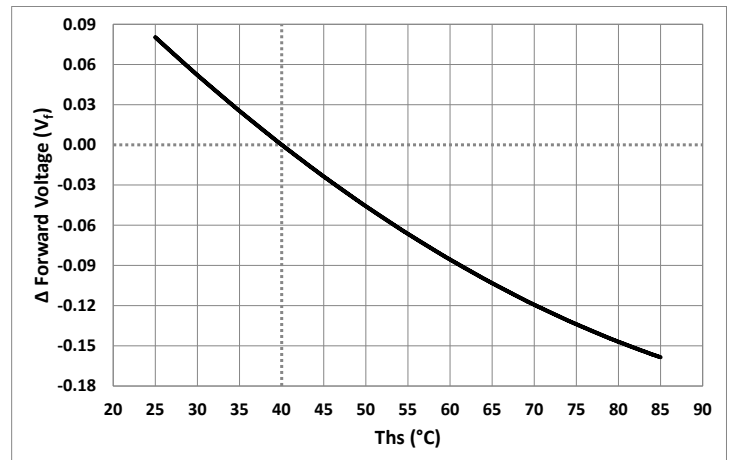
Relative Radiometric Power vs Forward Current

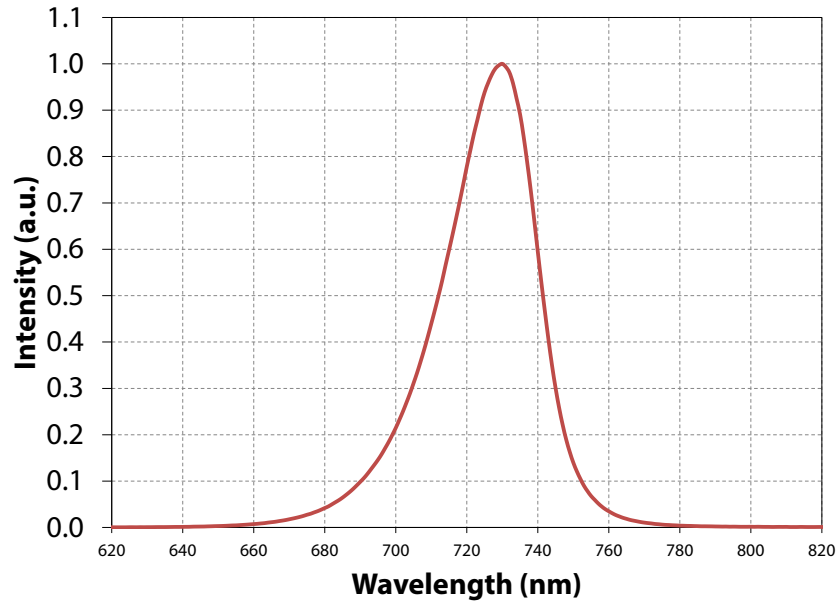
Relative Radiometric Power vs Heat Sink Temp.

Relative Peak Wavelength vs Forward Current

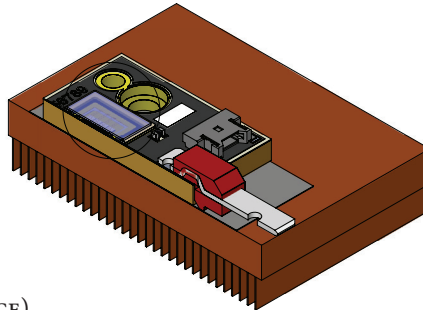
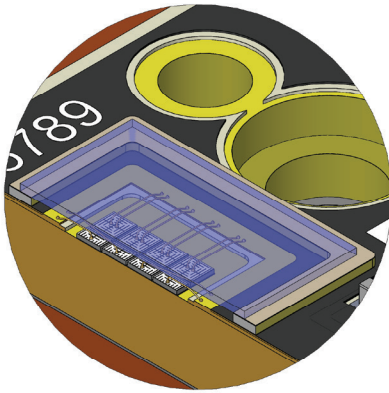
Relative Peak Wavelength vs Heat Sink Temp.

Relative Forward Voltage vs Forward Current

Relative Forward Voltage vs Heat Sink Temp.

Typical Spectrum

Thermal Resistance CBM-120



Typical Thermal Resistance ⁶

$R_{\theta j-b}$ ⁷	0.64 °C/W
$R_{\theta b-hs}$ ⁸	0.12 °C/W
$R_{\theta j-hs}$ ⁸	0.76 °C/W
$R_{\theta j-ref}$ ⁷	0.67 °C/W

Note 6: Real thermal resistance data - "Electrical" thermal resistance values available upon request

Note 7: Thermal resistance values are based on engineering modeled data.

Note 8: Thermal Resistance is based on eGraf 1205 Thermal interface.

T_J = DIE JUNCTION TEMP
 T_B = COREBOARD TEMP
 T_{HS} = HEATSINK TEMP (3MM FROM SURFACE)
 T_{REF} - THERMISTOR TEMP

Electrical Pinout

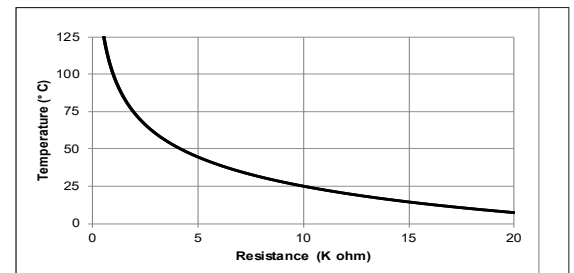
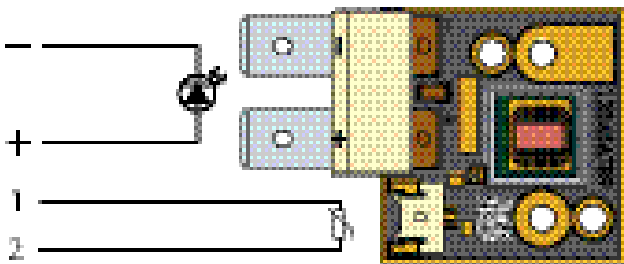

The thermistor used in CBT-120 devices mounted on coreboards is from Murata Manufacturing Co. The global part number is NCP18XH103J03RB. Please see <http://www.murata.com/> for details on calculating thermistor temperature.

For more information on use of the thermistor, please contact Luminus directly.

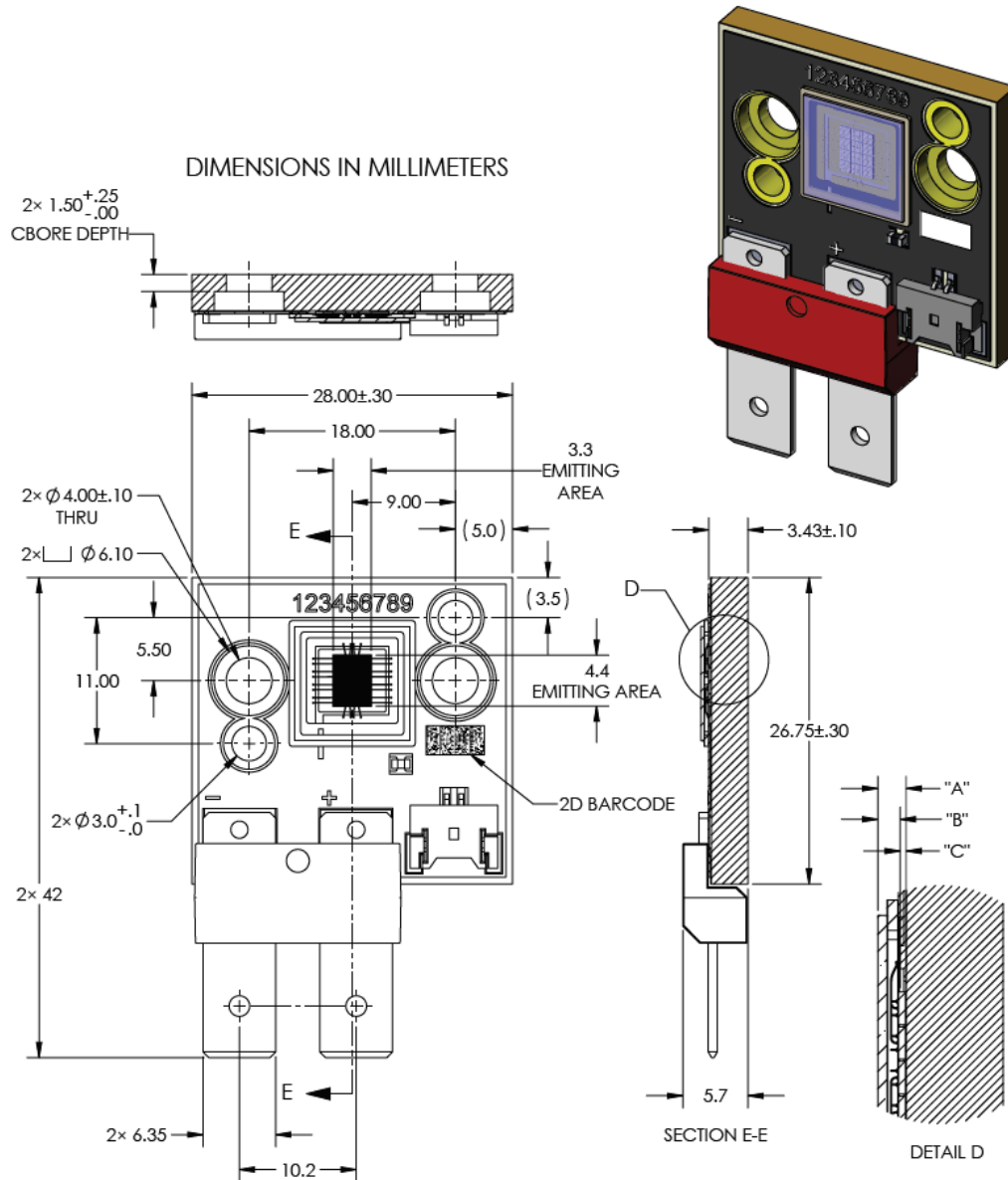
Mechanical Dimensions – CBM-120 Mosaic Array LED Emitter

DIMENSION NAME	DESCRIPTION	NOMINAL DIMENSION	TOLERANCE
"A"	TOP OF METAL SUBSTRATE TO TOP OF WINDOW	.93	±.13
"B"	TOP OF EMITTING AREA TO TOP OF WINDOW	.68	±.13
"C"	TOP OF METAL SUBSTRATE TO TOP OF EMITTING AREA	.25	±.03

DWG-002906

Recommended connector for Anode and Cathode:

Panduit Disco Lok™ Series P/N: DNF14-250FIB-C or JST Manufacturing Co: SPS-61T-250 for AWG 16 to 14.

Panduit Disco Lok™ Series P/N: DNF10-250FIB-L or JST Manufacturing Co: SPS-91T-250 for AWG 12 to 10.

(Check NEC standards for ampacity of the power cable being used.)

Thermistor Connector: GCT P/N WTB08-021S-F.

Recommended Female: MOLEX P/N 51146-0200 (Not recommended for new designs), GCT P/N WTB06-020H-A or equivalent.

Shipping Tray Outline

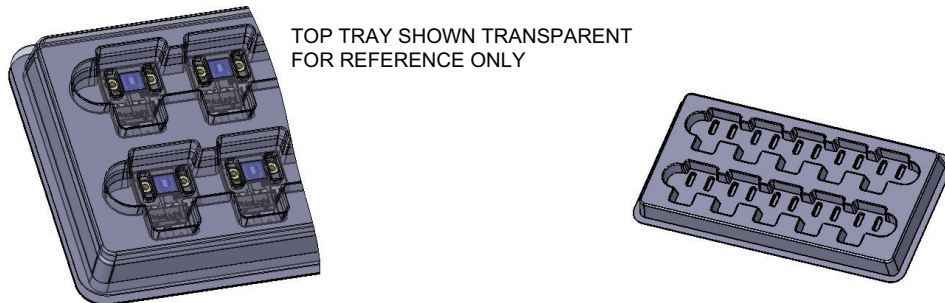
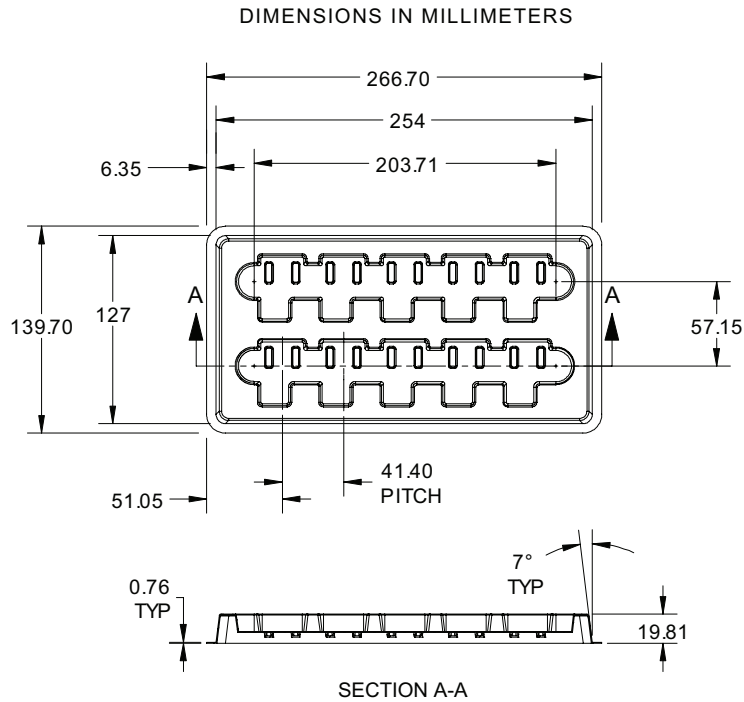

Packing and Shipping Specification (CBM-120)

Packing Specification

Packing Configuration	Qty /Pack	Reel Dimensions (diameter x W, mm)	Gross Weight (kg)
Stack of 5 trays with 10 devices per tray Each pack is enclosed in ESD bag	50	150 x 280 x 85	2.7

Product Label Specification

Label Fields (subject to change):

- 6-8 digit Box number (for Luminus internal use)
- Luminus ordering part number
- Quantity of devices in pack
- Part number revision (for Luminus internal use)
- Customer's part number (optional)
- Bin (FF-WW) as defined page 3
- 2D Bar code





LUMINUS
LEADER IN BIG CHIP LEDS Solid State Filament™

BT-012345

Box number

PT-120-G-L11-MPG

Luminus part number

12345678

Customer part number

5F

Bin

Qty: 50

Rev 01



for traceability peel off label and attach

RoHS Compliant

Sample label – for illustration only

Shipping Box

Shipping Box	Quantity	Material	Dimensions (L x W x H, mm)
Carton Box	1 -20 packs (50 - 1000 Devices)	S4651	560 x 560 x 200



History of Changes

Rev		Description of Change
A	08/03/2015	Initial Release - Preliminary Specifications for 740nm Parts
B	01/29/2016	Updated Mechanical Drawing, Typical Parametric Values, Packaging Specifications, Ordering Information
01	03/25/2016	Updated Thermal Resistance Drawing, Updated Binning
02	09/09/2016	Updated Mechanical Drawing and Corrected Typos
03	02/26/2020	Updated: - Rth junction to board value on page 2 - Binning Structures on page 3 (added P720 & P725) - Typical Performances on page 5 - Optical & Electrical Characteristics on page 6 - Mechanical Drawing on page 9 including connector information

The products, their specifications and other information appearing in this document are subject to change by Luminus Devices without notice. Luminus Devices assumes no liability for errors that may appear in this document, and no liability otherwise arising from the application or use of the product or information contained herein. None of the information provided herein should be considered to be a representation of the fitness or suitability of the product for any particular application or as any other form of warranty. Luminus Devices' product warranties are limited to only such warranties as accompany a purchase contract or purchase order for such products. Nothing herein is to be construed as constituting an additional warranty. No information contained in this publication may be considered as a waiver by Luminus Devices of any intellectual property rights that Luminus Devices may have in such information.

This product is protected by U.S. Patents 6,831,302; 7,074,631; 7,083,993; 7,084,434; 7,098,589; 7,105,861; 7,138,666; 7,166,870; 7,166,871; 7,170,100; 7,196,354; 7,211,831; 7,262,550; 7,274,043; 7,301,271; 7,341,880; 7,344,903; 7,345,416; 7,348,603; 7,388,233; 7,391,059 Patents Pending in the U.S. and other countries.