

MSA-0836

Cascadable Silicon Bipolar MMIC Amplifier



Data Sheet

Description

The MSA-0836 is a high performance silicon bipolar Monolithic Microwave Integrated Circuit (MMIC) housed in a cost effective, microstrip package. This MMIC is designed for use as a general purpose 50Ω gain block above 0.5 GHz and can be used as a high gain transistor below this frequency. Typical applications include narrow and moderate band IF and RF amplifiers in commercial and industrial applications.

The MSA-series is fabricated using Avago's 10 GHz f_T , 25 GHz f_{MAX} , silicon bipolar MMIC process which uses nitride self-alignment, ion implantation, and gold metallization to achieve excellent performance, uniformity and reliability. The use of an external bias resistor for temperature and current stability also allows bias flexibility.

Features

- Usable Gain to 6.0 GHz
- High Gain:
 - 32.5 dB Typical at 0.1 GHz
 - 23.0 dB Typical at 1.0 GHz
- Low Noise Figure: 3.0 dB Typical at 1.0 GHz
- Cost Effective Ceramic Microstrip Package

36 micro-X Package

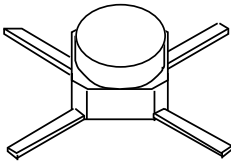

Typical Biasing Configuration

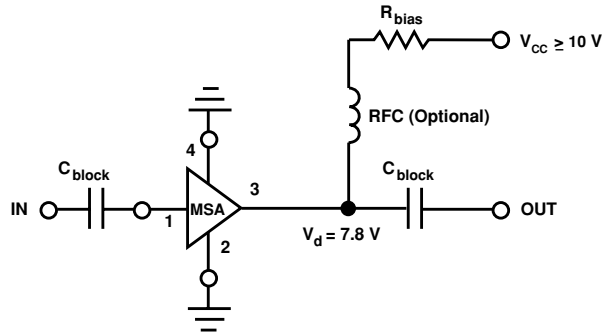

MSA-0836 Absolute Maximum Ratings

Parameter	Absolute Maximum ^[1]
Device Current	80 mA
Power Dissipation ^[2,3]	750 mW
RF Input Power	+13 dBm
Junction Temperature	150°C
Storage Temperature ^[4]	-65°C to 150°C

Thermal Resistance^{[2,5]:}

$$\theta_{jc} = 175^{\circ}\text{C/W}$$

Notes:

1. Permanent damage may occur if any of these limits are exceeded.
2. $T_{\text{CASE}} = 25^{\circ}\text{C}$.
3. Derate at 5.7 mW/°C for $T_{\text{C}} > 69^{\circ}\text{C}$.
4. Storage above +150°C may tarnish the leads of this package making it difficult to solder into a circuit.
5. The small spot size of this technique results in a higher, though more accurate determination of θ_{jc} than do alternate methods.

Electrical Specifications^[1], $T_{\text{A}} = 25^{\circ}\text{C}$

Symbol	Parameters and Test Conditions: $I_{\text{d}} = 36 \text{ mA}$, $Z_{\text{o}} = 50 \Omega$	Units	Min.	Typ.	Max.
G _P	Power Gain ($ S_{21} ^2$)	f = 0.1 GHz		32.5	
		f = 1.0 GHz	22.0	23.0	25.0
		f = 4.0 GHz		10.5	
VSWR	Input VSWR	f = 1.0 to 3.0 GHz		2.0:1	
	Output VSWR	f = 1.0 to 3.0 GHz		1.5:1	
NF	50 Ω Noise Figure	f = 1.0 GHz		3.0	
P _{1 dB}	Output Power at 1 dB Gain Compression	f = 1.0 GHz		12.5	
IP ₃	Third Order Intercept Point	f = 1.0 GHz		27.0	
t _D	Group Delay	f = 1.0 GHz		125	
V _d	Device Voltage	V	7.0	7.8	8.4
dV/dT	Device Voltage Temperature Coefficient	mV/°C		-17.0	

Note:

1. The recommended operating current range for this device is 20 to 40 mA. Typical performance as a function of current is on the following page.

Ordering Information

Part Numbers	No. of Devices	Comments
MSA-0836-BLKG	100	Bulk
MSA-0836-TR1G	1000	7" Reel

MSA-0836 Typical Scattering Parameters^[1] ($Z_0 = 50 \Omega$, $T_A = 25^\circ\text{C}$, $I_d = 36 \text{ mA}$)

Freq. GHz	S_{11}		S_{21}			S_{12}			S_{22}		k
	Mag	Ang	dB	Mag	Ang	dB	Mag	Ang	Mag	Ang	
0.1	.63	-17	32.5	42.02	161	-37.7	.013	55	.63	-19	0.72
0.2	.58	-33	31.5	37.52	145	-33.7	.021	47	.56	-37	0.73
0.4	.49	-56	29.1	28.50	119	-29.7	.033	54	.42	-66	0.72
0.6	.40	-70	26.7	21.54	103	-27.9	.040	55	.32	-84	0.78
0.8	.35	-80	24.6	17.01	92	-26.0	.050	53	.24	-98	0.85
1.0	.33	-89	22.9	13.98	82	-24.9	.057	52	.18	-107	0.89
1.5	.30	-111	19.5	9.45	64	-22.1	.079	51	.09	-126	0.95
2.0	.30	-133	16.9	7.03	48	-20.2	.098	44	.07	-141	0.99
2.5	.32	-150	14.9	5.53	39	-19.2	.110	42	.06	-166	1.04
3.0	.34	-170	13.2	4.56	26	-18.3	.122	36	.06	-106	1.06
3.5	.38	175	11.7	3.86	14	-17.5	.133	32	.08	-100	1.08
4.0	.39	162	10.5	3.33	2	-16.7	.146	27	.12	-101	1.08
5.0	.41	132	7.9	2.47	-21	-15.6	.165	19	.21	-113	1.10
6.0	.52	95	5.8	1.94	-45	-14.6	.187	7	.20	-149	1.05

Typical Performance, $T_A = 25^\circ\text{C}$

(unless otherwise noted)

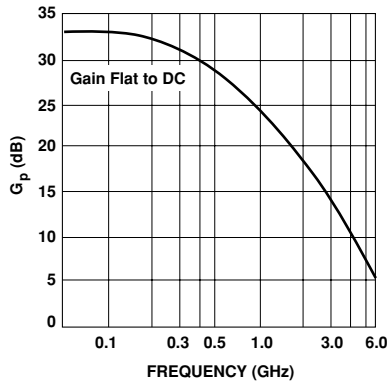
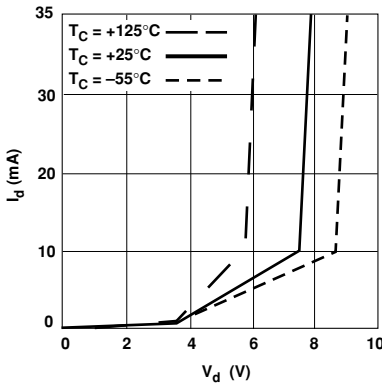
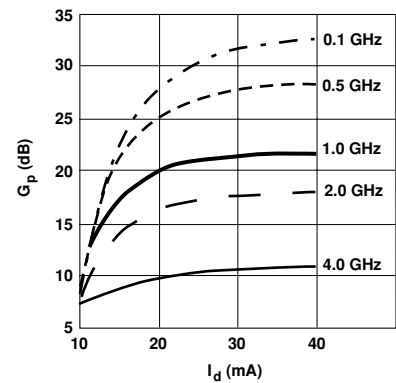
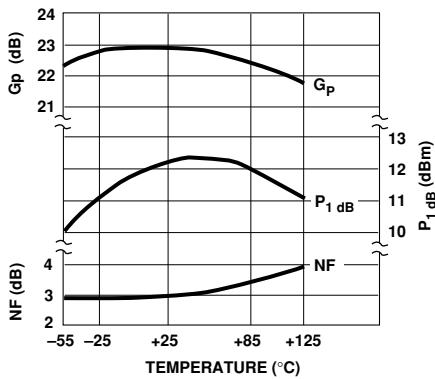
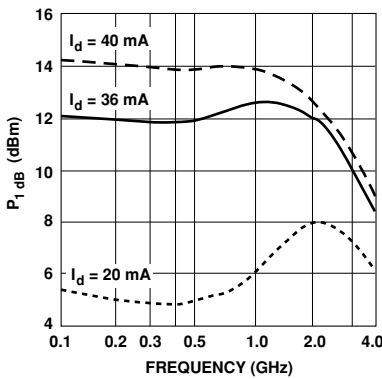
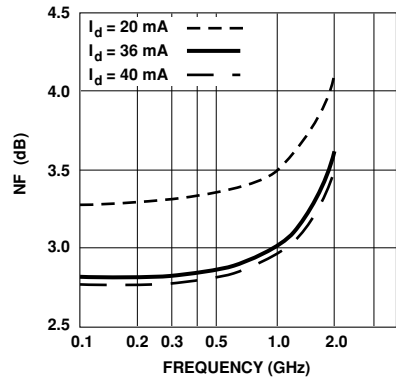
Figure 1. Typical Power Gain vs. Frequency, $I_d = 36 \text{ mA}$.

Figure 2. Device Current vs. Voltage.

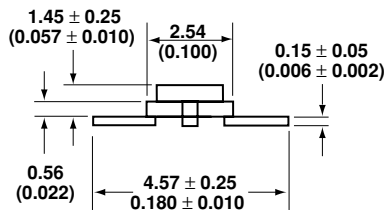
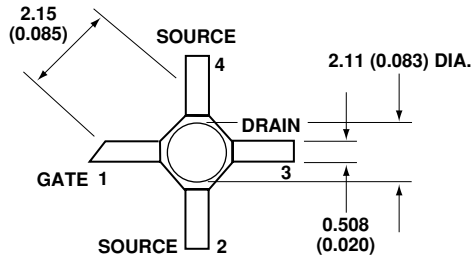
Figure 3. Power Gain vs. Current.

Figure 4. Output Power at 1 dB Gain Compression, NF and Power Gain vs. Case Temperature, $f = 1.0 \text{ GHz}$, $I_d = 36 \text{ mA}$.

Figure 5. Output Power at 1 dB Gain Compression vs. Frequency.

Figure 6. Noise Figure vs. Frequency.

36 micro-X Package Dimensions



Notes:

1. Dimensions are in millimeters (inches)
2. Tolerances: in .xxx = ± 0.005
mm .xx = ± 0.13

For product information and a complete list of distributors, please go to our web site: www.avagotech.com

Avago, Avago Technologies, and the A logo are trademarks of Avago Technologies, Limited in the United States and other countries. Data subject to change. Copyright © 2007 Avago Technologies, Limited. All rights reserved. Obsoletes 5989-2742EN AV02-0306EN - April 12, 2007

AVAGO
TECHNOLOGIES