

1N4448WS

SOD-323

200mW SOD-323 Fast Switching Diode

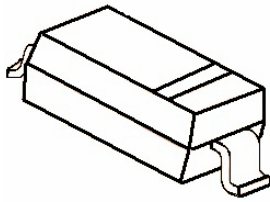

特征 Features

- 开关速度小于 4.0nS; Fast Switching Device (TRR <4.0 nS)
- 最大功率耗散 200mW; Power Dissipation of 200mW
- 高稳定性和可靠性。High Stability and High Reliability
- 反向漏电流小。Low reverse leakage

机械数据 Mechanical Data

- 封装: SOD-323 封装 SOD-323 Small Outline Plastic Package
- 极性: 色环端为负极 Polarity: Color band denotes cathode end
- 环氧树脂 UL 易燃等级 Epoxy UL: 94V-0
- 安装位置: 任意 Mounting Position: Any

极限值和温度特性(TA = 25°C 除非另有规定)

Maximum Ratings & Thermal Characteristics (Ratings at 25°C ambient temperature unless otherwise specified.)

参数 Parameters	符号 Symbol	数值 Value	单位 Unit
反向电压 Reverse Voltage	V _R	75	V
反向峰值电压 Peak Reverse Voltage	V _{RM}	100	V
功率消耗 Power Dissipation	P _d	500	mW
工作结温 Operating junction temperature	T _j	150	°C
存储温度 Storage temperature range	T _s	-55-+150	°C
反向工作电压 Working Inverse Voltage	W _{IV}	75	V
平均整流电流 Average Rectified Current	I _o	250	mA
正向(不重复)电流 Non-repetitive Peak Forward Current	I _{FM}	500	mA
正向(不重复)浪涌电流 Peak Forward Surge Current	I _{FSM}	2.0	A

@tp=1us; TA=25°C

Valid provided that electrodes are kept at ambient temperature.

电特性 Electrical Characteristics (Ratings at 25°C ambient temperature unless otherwise specified).

符号 Symbols	参数 Parameter	测试条件 Test Condition	界限 Limits		单位 Unit
			Min	Max	
BV	反向击穿电压	IR=100uA	100	---	V
	Breakdown Voltage	IR=5uA	75		
IR	反向漏电流	VR=20V	---	25	nA
	Reverse Leakage Current	VR=75	---	2.5	uA
VF	正向电压 Forward Voltage	IF=5mA	0.62	0.72	V
		IF=10mA	---	0.855	
		IF=100mA	---	1.0	
		IF=150mA	---	1.25	
TRR	反向恢复时间	IF= 10mA, IR=10mA	---	4	nS
	Reverse Recovery Time	RL=100Ω			
		IRR=0.1mA			
C	结电容	VR=0V, f=1MHZ	---	4	pF
	Capacitance				

1N4448WS

Forward Characteristics

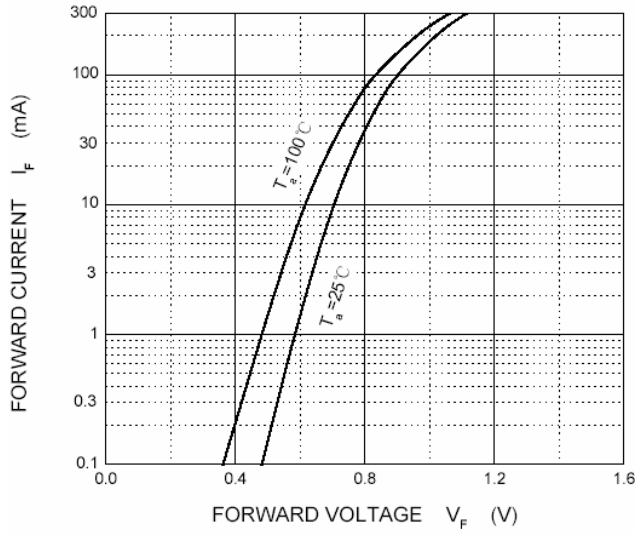

Reverse Characteristics

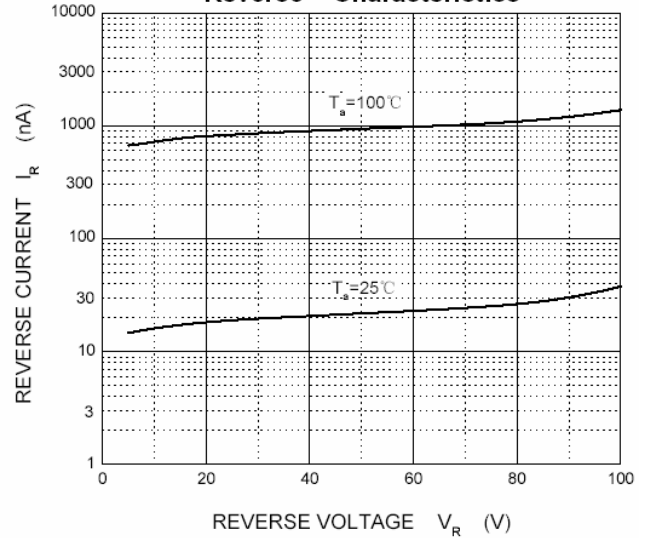

Capacitance Characteristics

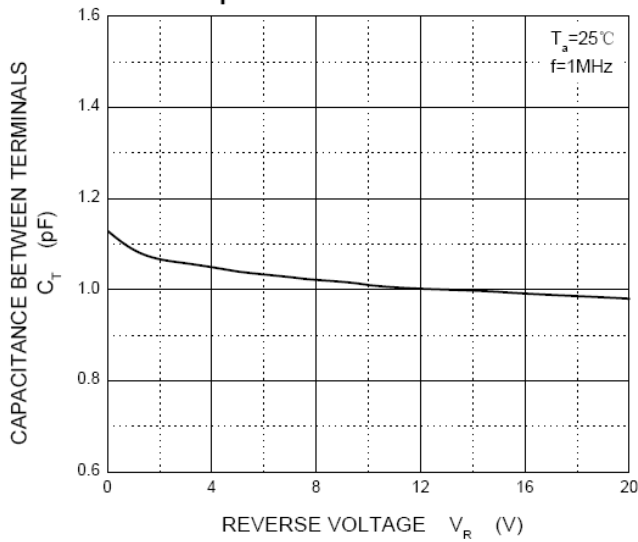

Power Derating Curve

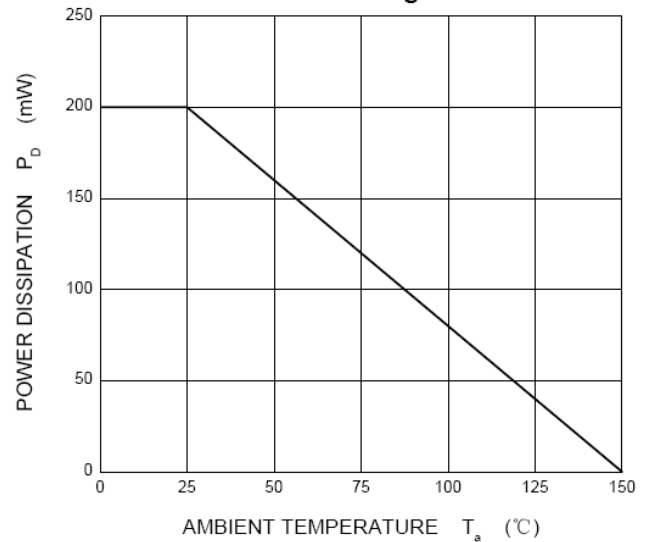

SOD-323 PACKAGE OUTLINE Plastic surface mounted package

SOD-323

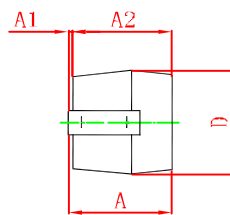
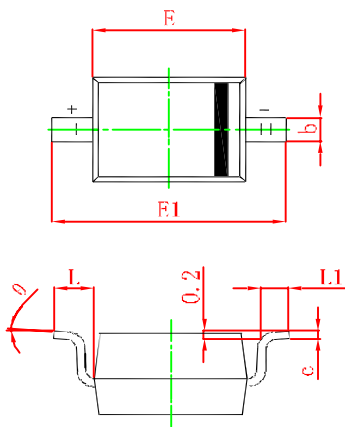

Symbol	Min.(mm)	Max.(mm)
A		1.000
A1	0.000	0.100
A2	0.800	0.900
b	0.250	0.350
c	0.080	0.150
D	1.200	1.400
E	1.600	1.800
E1	2.500	2.700
L	0.475REF	
L1	0.250	0.400
θ	0°	8°