



Features

- High sensitivity, super light weight
- Conforms to FCC part 68
- PC board mounting
- Available bifurcated contacts for high reliability

Contact Data*

	J104A & J104B - Bifurcated Contacts Standard Version	J104C - Bifurcated Contacts Low Cost Version
Contact Arrangement	2C = DPDT	2C = DPDT
Contact Rating	2A @ 30VDC 3A @ 30VDC N.O. .6A @ 125VAC	1A @ 24VDC 1A @ 125VAC
Contact Resistance	< 50 milliohms initial	< 50 milliohms initial
Contact Material	AgNi + Au clad	Ag
Maximum Switching Power	60W, 75VA	24W, 125VA
Maximum Switching Voltage	250VAC, 220VDC	250VAC, 220VDC
Maximum Switching Current	3A	3A

Coil Data*

Coil Voltage VDC		Coil Resistance Ω +/- 10%						Pick Up Voltage VDC (max) 75% of rated voltage	Release Voltage VDC (min) 10% of rated voltage	Coil Power W	Operate Time ms	Release Time ms
Rated	Max	.15W	.20W	.36W	.40W	.51W	.55W					
3	3.9	60	45	25	23	17.6	16	2.25	.3	.15 .20 .36 .40 .51 .55	4.5	1.5
5	6.5	167	125	56	63	39.7	45	3.75	.5			
9	11.7	540	405	100	203	70.6	140	6.75	.9			
12	15.6	960	720	400	360	282	280	9.00	1.2			
24	31.2	N/A	2880	1600	1440	1129	1070	18.00	2.4			
48	62.4	N/A	11.5K	N/A	5760	4518	3900	36.00	4.8			

General Data*

Electrical Life @ rated load	500K cycles, average		
Mechanical Life	100M cycles, average		
Insulation Resistance	100M Ω min. @ 500VDC initial		
Dielectric Strength	J104A & J104B	J104C	
	Coil to Contact	1500V rms min. initial	1000V rms min. initial
	Contact to Contact	1000V rms min. initial	500V rms min. initial
Shock Resistance	100m/s ² for 11 ms		
Vibration Resistance	1.50mm double amplitude 10~40Hz		
Terminal (Copper Alloy) Strength	5N		
Operating Temperature	-40°C to +85°C		
Storage Temperature	-40°C to +155°C		
Solderability	260°C for 5 s		
Weight	4.5g		

* Values can change due to the switching frequency, desired reliability levels, environmental conditions and in-rush load levels. It is recommended to test actual load conditions for the application. It is the user's responsibility to determine the performance suitability for their specific application. The use of any coil voltage less than the rated coil voltage may compromise the operation of the relay.

J104

Ordering Information

1. Series	J104A	2C	12VDC	.55	S
J104A	**.40W, .55W coil power only				
J104B	**.15W, .20W coil power only				
J104C	**.20W, .36W, .51W coil power only (only available on 5, 12 & 24 VDC coil)				
2. Contact Arrangement	2C = DPDT				
3. Coil Voltage	3VDC 5VDC 9VDC 12VDC 24VDC **not available with .15W coil power 48VDC **not available with .15W or .36W coil power				
4. Coil Power	J104A	J104B	J104C		
.40 = .40W	.15 = .15W	.20 = .20W	.36 = .36W		
.55 = .55W	.20 = .20W	.51 = .51W			
5. Sealed	S = Sealed (standard)				

Dimensions

Units = mm

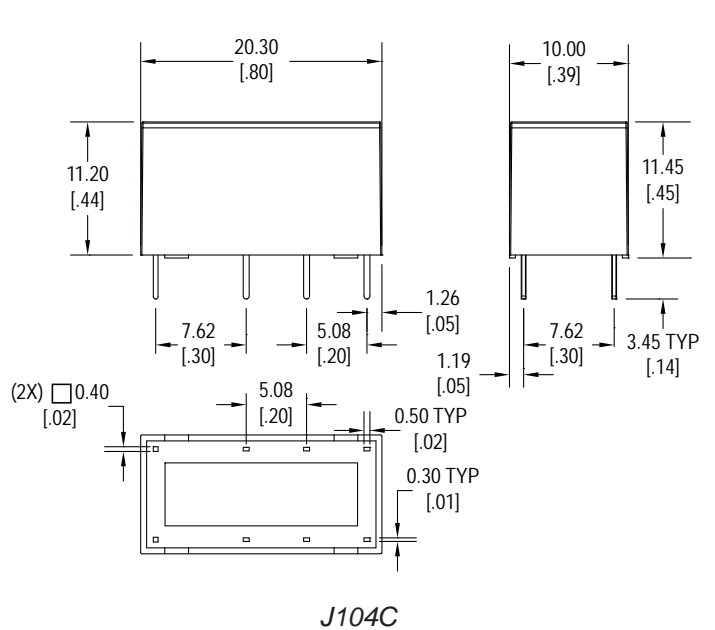
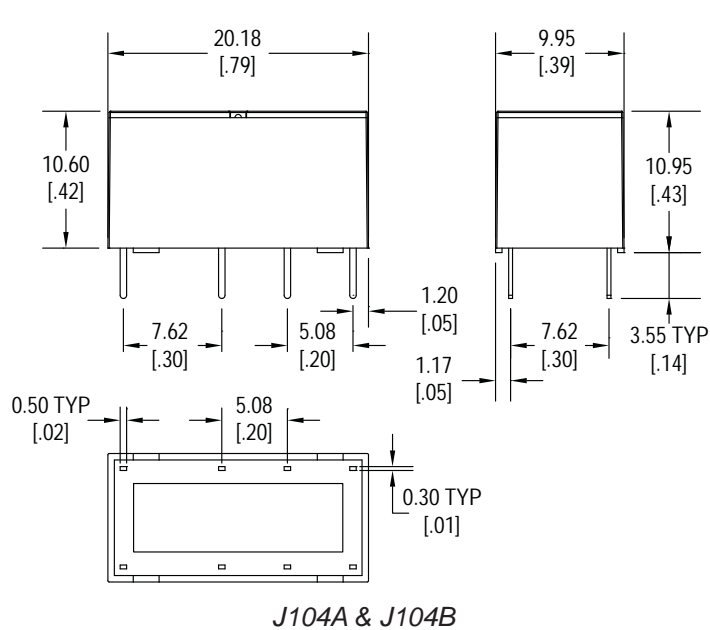

Schematics & PC Layouts

Bottom Views

