



WBFBP-06C Plastic-Encapsulate Diode

FBAS40DW-05

SURFACE MOUNT SCHOTTKY BARRIER DIODE ARRAYS

DESCRIPTION

Silicon epitaxial planar

PN Junction Guard Ring for Schottky Diode

FEATURES

- Low Forward Voltage Drop
- Fast Switching
- Ultra-Small Surface Mount Package

APPLICATION

For General Purpose Switching Applications, rectifiers
 For portable equipment:(i.e. Mobile phone,MP3, MD,CD-ROM,
 DVD-ROM, Note book PC, etc.)

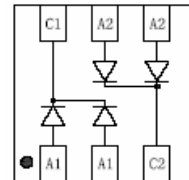

FBAS40DW-05

Marking:K45

Maximum Ratings @ $T_A=25^{\circ}\text{C}$

Parameter	Symbol	Limits	Unit
Peak Repetitive reverse voltage	V_{RM}	40	V
DC Blocking Voltage	V_R		
Average Rectified Output Current	I_O	40	mA
Power Dissipation	P_d	150	mW
Thermal Resistance. Junction to Ambient Air	$R_{\theta JA}$	625	$^{\circ}\text{C}/\text{W}$
Junction temperature	T_J	125	$^{\circ}\text{C}$
Storage temperature range	T_{STG}	-65-125	$^{\circ}\text{C}$

ELECTRICAL CHARACTERISTICS ($T_{amb}=25^{\circ}\text{C}$ unless otherwise specified)

Parameter	Symbol	Test conditions	MIN	MAX	UNIT
Reverse voltage leakage current	I_R	$V_R=30\text{V}$		200	nA
Forward voltage	V_F	$I_F=1\text{mA}$ $I_F=40\text{mA}$		380 1000	mV
Total capacitance	C_T	$V_R=0, f=1\text{MHz}$		5	pF
Reverse recovery time	t_{rr}	$I_F=I_R=10\text{mA}, I_{rr}=0.1 \times I_R,$ $R_L=100\ \Omega$		5	nS

Typical Characteristics

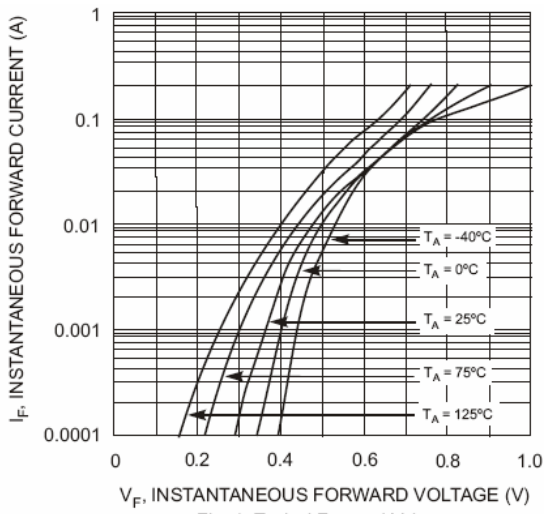

Fig. 1 Typical Forward Voltage

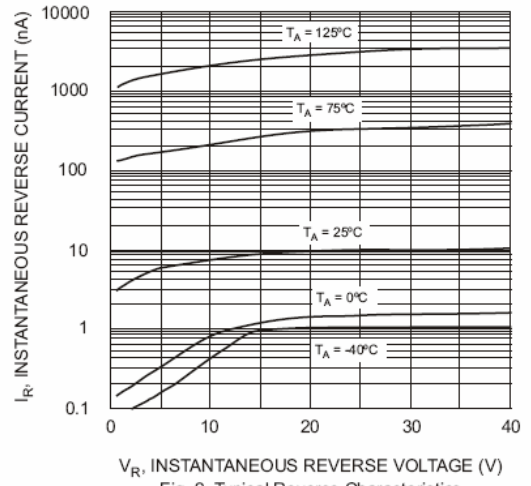

Fig. 2 Typical Reverse Characteristics

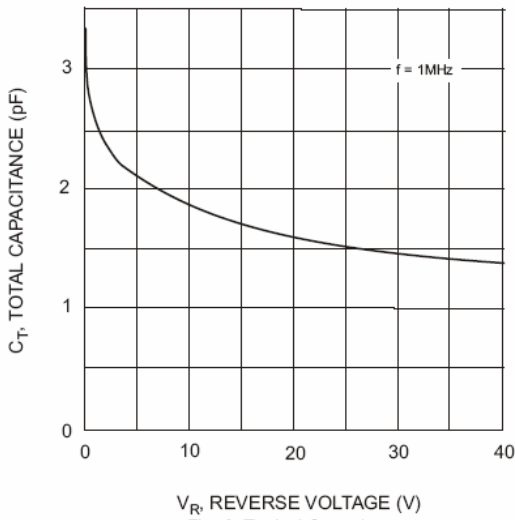

Fig. 3 Typical Capacitance

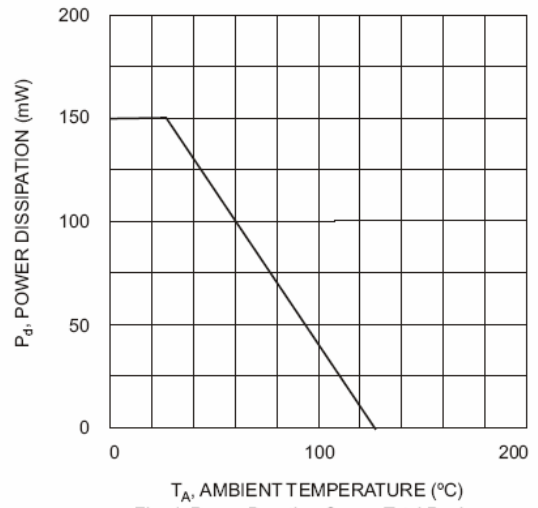
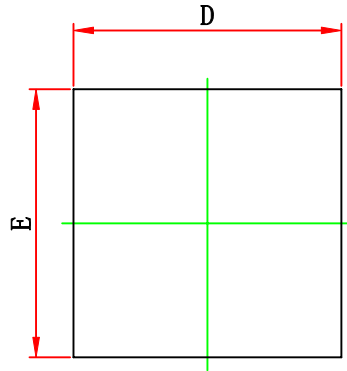

Fig. 4 Power Derating Curve, Total Package



WBFBP-06C(2×2×0.5) PACKAGE OUTLINE DIMENSIONS



TOP VIEW

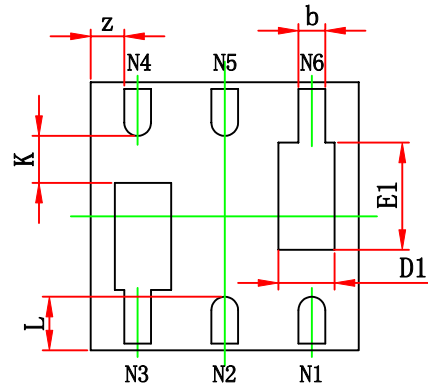

BOTTOM VIEW

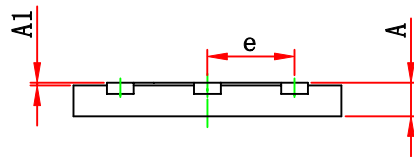

SIDE VIEW

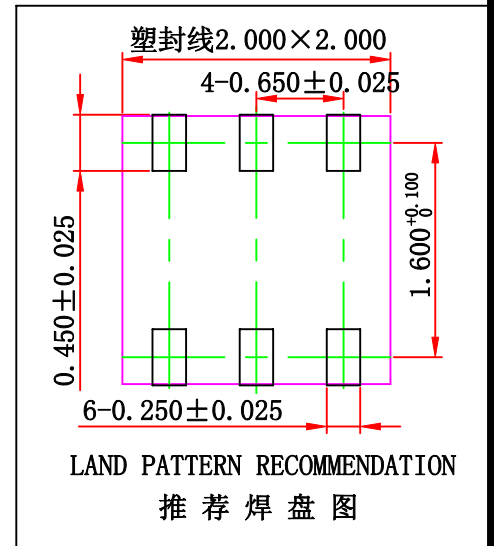

Symbol	Dimensions In Millimeters		Dimensions In Inches	
	Min.	Max.	Min.	Max.
A	0.450	0.550	0.018	0.022
A1	0.000	0.100	0.000	0.004
b	0.150	0.250	0.006	0.010
D	1.900	2.100	0.075	0.083
E	1.900	2.100	0.075	0.083
D1	0.420 REF.		0.017 REF.	
E1	0.800 REF.		0.032 REF.	
e	0.650 TYP.		0.026 TYP.	
L	0.400 REF.		0.016 REF.	
k	0.350 REF.		0.014 REF.	
z	0.500 REF.		0.020 REF.	

APPLICATION CIRCUITS

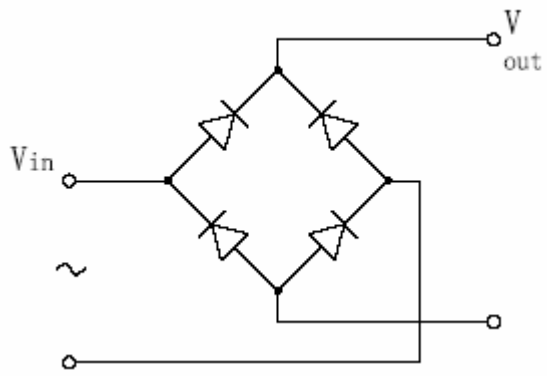

Bridge rectifiers