



General Purpose Relay

MK

- Exceptionally reliable general purpose relay
- Long life (minimum 100,000 electrical operations) assured by silver contacts
- Built-in operation indicator (mechanical, LED), diode surge suppression, Varistor surge suppression
- The contact operation can be easily checked by mechanical indicator and/or push-to-test button options
- Conforms to CENELEC standards
- VDE approved versions available



Ordering Information

To Order: Select the part number and add the desired coil voltage rating (e.g., MK3P5-S-AC120).

Type	Terminal	Coil	Contact form	Part number	
				Mechanical indicator	Mechanical indicator & push-to-test button
Standard	Plug-in	AC/DC	DPDT	MK2P-I	MK2P-S
			3PDT	MK3P-5-I	MK3P-5-S
LED indicator			DPDT	MK2PN-I	MK2PN-S
			3PDT	MK3PN-5-I	MK3PN-5-S
LED indicator and diode		DC	DPDT	MK2PND-I	MK2PND-S
			3PDT	MK3PND-5-I	MK3PND-5-S
LED indicator and varistor	AC	DPDT	MK2PNV-I	MK2PNV-S	
		3PDT	MK3PNV-5-I	MK3PNV-5-S	
Diode	DC	DPDT	MK2PD-I	MK2PD-S	
		3PDT	MK3PD-5-I	MK3PD-5-S	
Varistor	AC	DPDT	MK2PV-I	MK2PV-S	
		3PDT	MK3PV-5-I	MK3PV-5-S	

Note: 1. Reverse polarity versions available on DC coil types. Consult your OMRON representative for further information.
 2. VDE approved versions are available. Consult your OMRON representative for further information.

■ ACCESSORIES (Order separately)

To Order: Select the appropriate part numbers for sockets, clips, and mounting tracks (if required) from the available types chart.

Track mounted sockets

Relay type	Part number		
	Socket	Relay hold-down clip	Mounting track/end plate
SPDT DPDT	PF083A-E	PFC-A1	PFP-100N or PFP-50N and PFP-M (end plate)
3PDT	PF113A-E	PFC-A1	PFP-100N or PFP-50N and PFP-M (end plate)

■ **ACCESSORIES (continued)**

Back connecting sockets

Relay type	Part number	
	Socket	Relay hold-down clip
SPDT	PL08	PLC-E
DPDT	PLE08-0	PLC-10
	PL08-Q	PLC-E
3PDT	PL11	PLC-E
	PLE11-0	PLC-10
	PL11-Q	PLC-E

Specifications

■ **CONTACT DATA**

Load	Resistive load (p.f. = 1)		Inductive load (p.f. = 0.4)
	2 Pole	3 Pole	
Rated load	10 A at 250 VAC 10 A at 28 VDC	10 A at 120 VAC 10 A at 28 VDC 10 A at 250 VAC	7 A at 250 VAC
Contact material	Ag		
Carry current	10 A		
Max. operating voltage	250 VAC, 250 VDC		
Max. operating current	10 A		
Max. switching capacity	2,500 VA 280 W	2,500 VA/1,250 VA (NO/NC contacts) 280 W	1,750 VA
Min. permissible load	10 mA at 1 VDC		

■ **COIL DATA** ■

AC

Rated voltage (VAC)	Rated current (mA) (at 60 Hz)	Coil resistance (Ω)	Coil inductance (Ref. value) (H)		Pick-up voltage	Dropout voltage	Maximum voltage	Power consumption (mW)
			Armature OFF	Armature ON				
6	360	3.9	0.0423	0.0201	80% max. Approx. 2.7 VA	30% min. (at 60 Hz) 25% min. (at 50 Hz)	110% max.	Approx. 2.3 VA (at 60 Hz) Approx. 2.7 VA (at 50 Hz)
12	180	16.3	0.3270	0.1666				
24	88.0	68.0	0.6940	0.3760				
50	39.0	338	3.195	1.530				
110	21.0	1240	13.45	7.32				
120	18.0	1578	15.04	7.19				
220	11.0	5090	49.73	27.02				
240	9.2	6737	58.62	32.07				

DC

Rated voltage (VDC)	Rated current (mA) (at 60 Hz)	Coil resistance (Ω)	Coil inductance (Ref. value) (H)		Pick-up voltage	Dropout voltage	Maximum voltage	Power consumption (mW)
			Armature OFF	Armature ON				
6	255	23.5	0.206	0.106	80% max. Approx. 2.7 VA	15% min.	110% max.	Approx. 1.5 W
12	126	95	0.963	0.449				
24	56	430	4.915	2.478				
48	29.5	1630	16.685	10.487				
110	15.1	7300	80.2	42.6				

- Note:
1. The rated current and coil resistance are measured at a coil temperature of 23°C (73°F) with a tolerance of ±15% for DC rated current and +15%, -20% for AC rated current.
 2. The rated current is reference value.
 3. Performance characteristic data are measured at a coil temperature of 23°C (73°F).
 4. For models with the LED indicator built-in, add an LED current of approximately 0 thru 5 mA to the rated current.

■ CHARACTERISTICS

Contact resistance		50 mΩ max.
Operate time		AC: 20 ms max. DC: 30 ms max.
Release time		20 ms max.
Operating frequency	Mechanical	18,000 operations/hour
	Electrical	1,800 operations/hour (under rated load)
Insulation resistance		100 MΩ min. (at 500 VDC)
Dielectric strength		2,500 VAC, 50/60 Hz for 1 minute between coil and contacts 1,000 VAC, 50/60 Hz for 1 minute between contacts of same poles, between terminals of the same polarity 2,500 VAC, 50/60 Hz for 1 minute between current-carrying parts, noncurrent-carrying parts, and terminals of opposite polarity
Vibration	Mechanical durability	10 to 55 Hz, 1.50 mm (0.06 in) double amplitude
	Malfunction durability	10 to 55 Hz, 1.00 mm (0.04 in) double amplitude
Shock	Mechanical durability	1,000 m/s ² (approx. 100 G)
	Malfunction durability	100 m/s ² (approx. 10 G)
Ambient temperature		Operation: -10° to 40°C (14° to 104°F)
Humidity		35 to 85% RH
Service Life	Mechanical	10 million operations min. (at operating frequency of 18,000 operations/hour)
	Electrical	100,000 operations at rated load (at operating frequency of 1,800 operations/hour)
Weight		Approx. 0.85 g (3.0 oz)

Note: Data shown are of initial value.

■ CHARACTERISTIC DATA

Maximum switching capacity
MK2P-S, MK3P5-S

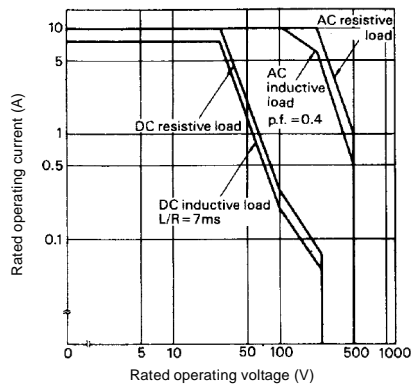

Electrical service life
MK2P-S, MK3P5-S

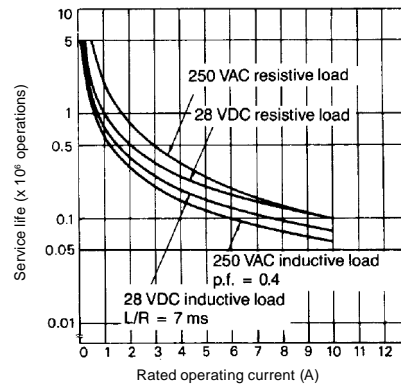

Dimensions

Unit: mm (inch)

RELAYS

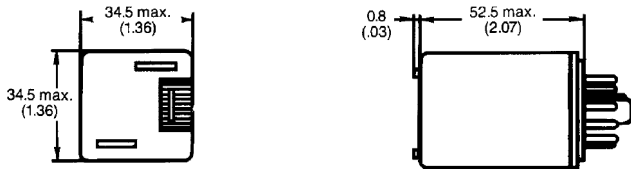

TERMINAL ARRANGEMENT (Bottom view)

Standard type (AC/DC coil)
MK2P-I, -S

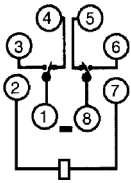

MK3P5-I, -S

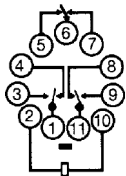

LED indicator type (AC coil)
MK2PN-I, -S

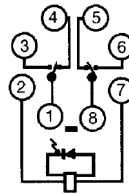

MK3PN-5-I, -S

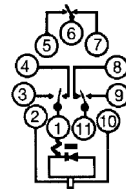

LED indicator type (DC coil)
MK2PN-I, -S

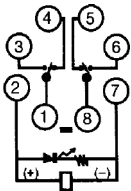

MK3PN-5-I, -S

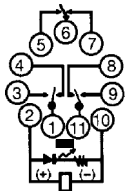

Diode type (DC coil)
MK2PD-I, -S

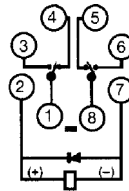

MK3PD-5-I, -S

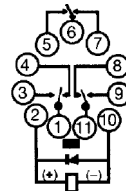

Varistor type (AC coil)
MK2PV-I, -S

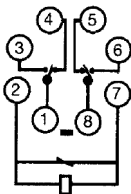

MK3PV-5-I, -S

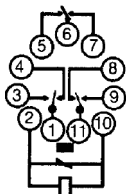

LED indicator and diode type (DC coil)
MK2PND-I, -S

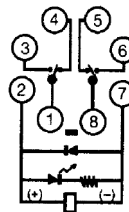

MK3PND-5-I, -S

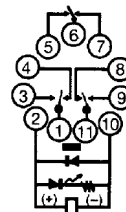

LED indicator and Varistor type (AC coil)
MK2PNV-I, -S

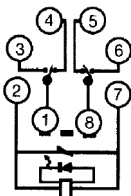

MK3PNV-5-I, -S

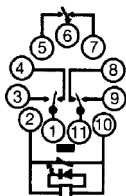

■ ACCESSORIES

**Track mounted socket
PF083A-E (conforming to DIN EN 50022)**

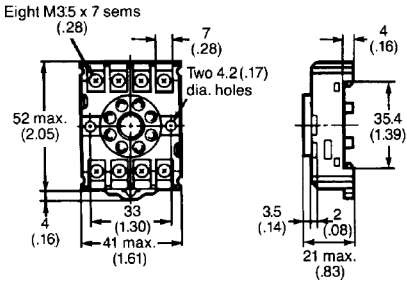

Terminal arrangement

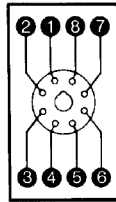

Mounting holes

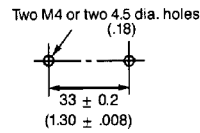

Mounting dimensions of relay with socket

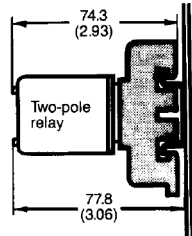

Note: Model PF083A-E can be used as a front connecting socket.

**Track mounted socket
PF113A-E (conforming to DIN EN 50022)**

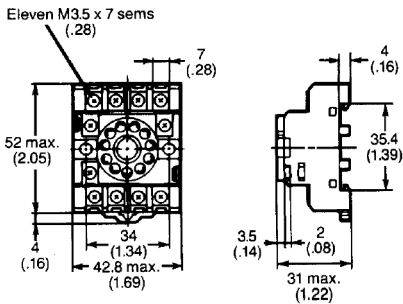

Terminal arrangement

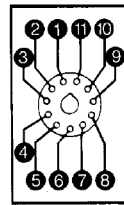

Mounting holes

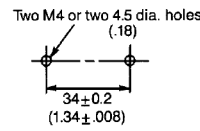

Mounting dimensions of relay with socket

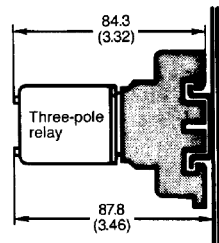

Note: Model PF113A-E can be used as a front connecting socket.

**Back connecting socket
MK2 sockets (8 pin)**

**PL08 (UL File No. E87929)
Solder terminals**

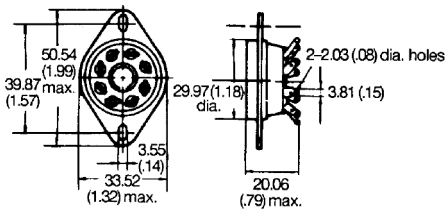

**PL08-Q
Wire wrap terminals**

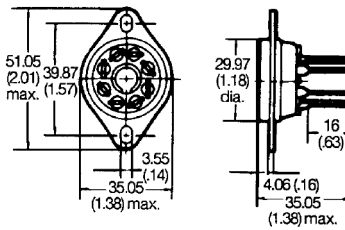

**Printed circuit board socket
PLE08-0**

PLE08-0

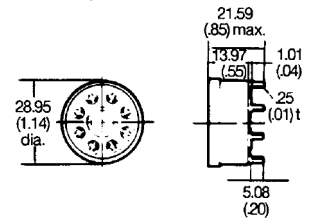

**Mounting holes
PL08**

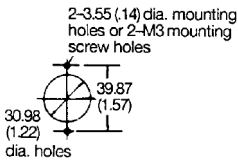

Mounting holes and panel cut-out applies to PL08 and PL08-Q

**PL08 type sockets and MK2 relay
Total height dimension**

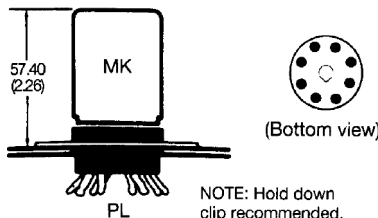

**Recommended PCB layout
PLE08-0**

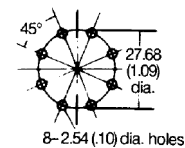

Unit: mm (inch)

■ ACCESSORIES (continued)

Back connecting socket
MK3 sockets (11 pin)

PL11 (UL File No. E87929)
Solder terminals

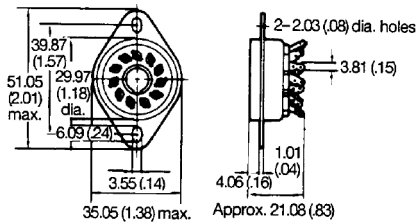

PL11-Q
Wire wrap terminals

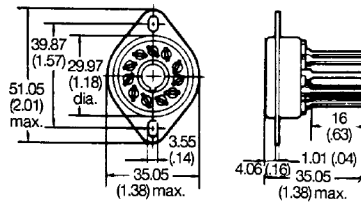

Printed circuit
board socket
PLE11-0

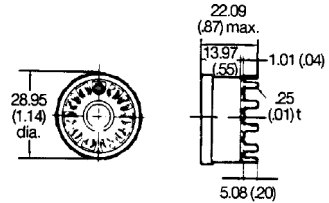

Mounting holes
PL11

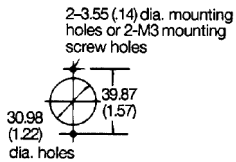

Mounting holes and panel cut-out
applies to PL11 and PL11-Q

PL11 type sockets and MK3 relay
Total height dimension

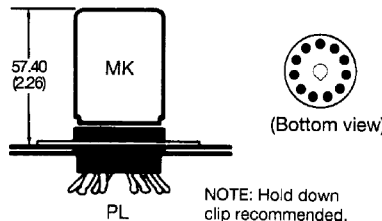

Recommended PCB layout
PLE11-0

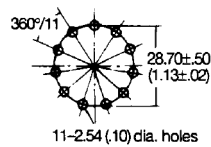

Mounting tracks

PFP-100N/PFP-50N
(conforming to DIN EN 500022)

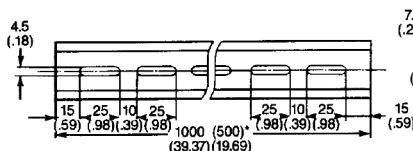

PFP-100N2
(conforming to DIN EN 500022)

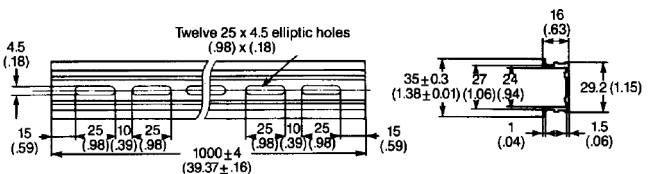

Note: 1. *This dimension applies to mounting track PFP-50N.
2. A total of twelve 25 x 4.50 mm (0.98 x 0.18 in) elliptical holes is provided with six holes cut from each rail end at a pitch of 10 mm (0.39 in) holes.

PFP-M end plate

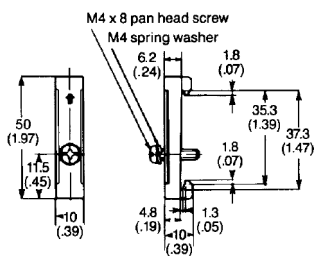

Note: Use of Type PFP-M end plate is recommended to secure the socket on the mounting track. Be sure that the engraved arrow mark on the surface of the end plate faces upward and then tighten the screw firmly with a screwdriver.

■ APPROVALS

UL (File No. E41515)/CSA (File Nos. LR41408 and LR335535)

Type	Contact form	Coil ratings	Contact ratings
MK2P-I, -S	DPDT	6 to 250 VAC 6 to 110 VDC	10 A, 250 VAC, Resistive
			10 A, 28 VDC, Resistive
			7 A, 250 VAC, Inductive
MK3P5-I, -S	3PDT	6 to 250 VAC 6 to 110 VDC	10 A, 120 VAC, Resistive
			10 A, 28 VDC, Resistive
			10 A, 250 VAC, Resistive
			7 A, 250 VAC, Inductive

SEV, DEMKO

Type	Contact form	Coil ratings	Contact ratings
MK2P-I, -S	DPDT	6 to 110 VDC	10 A, 250 VAC (NO) ($\cos\theta = 1$)
			5 A, 250 VAC (NC) ($\cos\theta = 1$)
			10 A, 280 VDC (NO)
MK3P5-I, -S	3PDT	6 to 240 VAC	5 A, 280 VDC (NC)
			7 A, 250 VAC ($\cos\theta = 0.4$)

TUV (File No. R9051410)

Type	Contact form	Coil ratings	Contact ratings
MK2P-I, -S	DPDT	6, 12, 24, 48, 100, 110 VDC	10 A, 250 VAC (NO) ($\cos\theta = 1$)
			5 A, 250 VAC (NC) ($\cos\theta = 1$)
			10 A, 280 VDC (NO)
MK3P5-I, -S	3PDT	6, 12, 24, 50, 110, 115, 120, 200, 220, 230, 240 VAC	5 A, 280 VDC (NC)
			7 A, 250 VAC ($\cos\theta = 0.4$)

- Note:
1. The rated values approved by each of the safety standards (e.g., UL and CSA) may be different from the performance characteristics individually defined in this catalog.
 2. VDE, Nemko and Semko versions are available. Please consult your OMRON representative for further information.
 3. In the interest of product improvement, specifications are subject to change.

OMRON ELECTRONICS, INC.

One East Commerce Drive
Schaumburg, IL 60173
1-800-55-OMRON

OMRON CANADA, INC.

885 Milner Avenue
Scarborough, Ontario M1B 5V8
416-286-6465