

KEMET, SCR25, AC Line Filters, Common Mode, 7000 uH

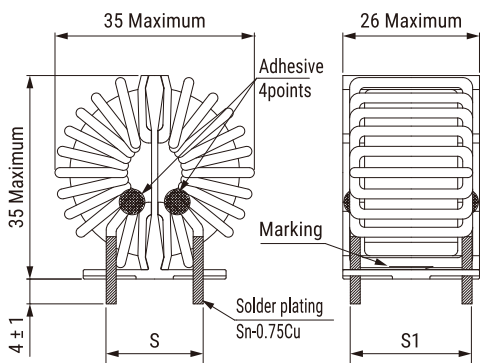

Dimensions

D	35mm MAX
L	35mm MAX
T	35mm MAX
H	26mm MAX
LL	4mm +/-1mm
S	14mm NOM

Packaging Specifications

Packaging:	Tray
Packaging Quantity:	180
Weight:	48 g

General Information

Series:	SCR25
Style:	Through-Hole
Features:	High Impedance, Space Saving
RoHS:	Yes
Miscellaneous:	80 (K) Temperature Rise Max.

Specifications

Voltage AC:	250 VAC
Inductance:	7000 uH
Current:	7 A
Temperature Range:	-25/+120C
DC Resistance:	34 mOhms