

Distinctive Characteristics

Brilliant illumination for highly visible status indication with LEDs and caps in red, green, or amber; subdued illumination for low light requirements with white cap over red, green, or amber LEDs.

Photo interrupter, rather than contacts, ensures high reliability and long life of 3 million operations minimum.

Rugged construction and smooth actuation allow repeated, rapid actuation force anywhere on cap surface.

Snap-in mounting for easy installation.

Connector socket with 6 pins for simple connection.

Well suited for gaming and vending machines, as well as equipment exposed to corrosive gases used in environments such as chemical or steel manufacturing plants.



Actual Size



TYPICAL SWITCH ORDERING EXAMPLE

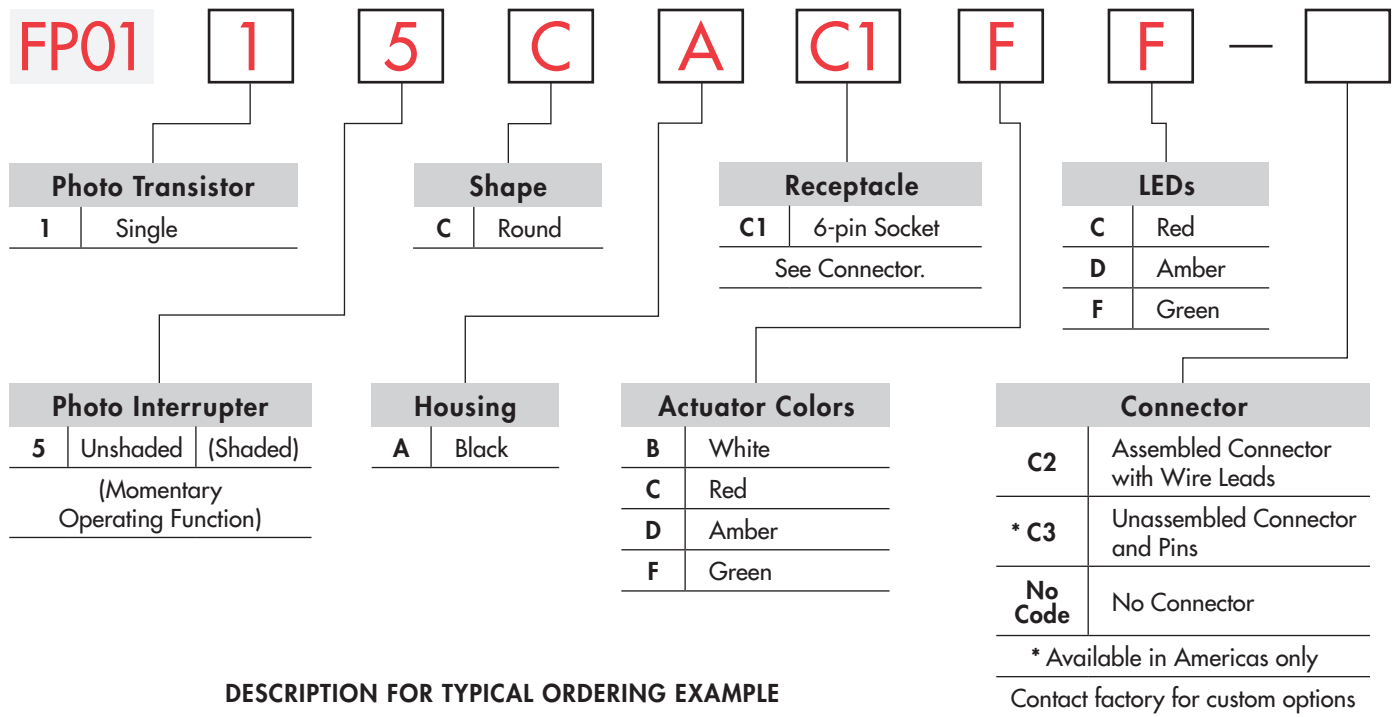

DESCRIPTION FOR TYPICAL ORDERING EXAMPLE

FP0115CAC1FF



ACTUATOR & INTERRUPTER

Model	Actuator Position	Photo Interrupter		Schematics
		Normal	Down	
1	<div style="display: flex; justify-content: space-around;"> <div>Normal </div> <div>Down </div> </div>	Unshaded	Shaded	LED connector pins are 5 & 6; interrupter connector pins are 3-4 & 1-2.
FP0115	Single Photo Transistor	When shaded, the photo transistor momentarily activates electrical function which signals the external device to change its state.		

HOUSING SHAPE & COLOR

C Round Shape **A** Black Housing

RECEPTACLE

C1 6-pin Socket

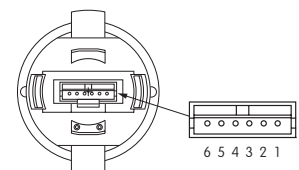

Toggles
Rockers
Pushbuttons
Illuminated PB
Programmable
Keylocks
Rotaries
Slides
Tactiles
Tilt
Touch
Indicators
Accessories
Supplement

SWITCH SPECIFICATIONS

	Actuator Up	Actuator Down
Status of Photo Interrupter:	Unshaded	Shaded
Collector Current I_C :	0.8mA minimum	10 μ A maximum
Status of Photo Transistor:	On	Off
Output Condition of Photo Transistor:	$I_F = 20\text{mA}$ & $V_{CE} = 5\text{V}$	

MECHANICAL SPECIFICATIONS

Total Travel:	.079" (2.0mm)
Operating Force:	0.75 N (.169 lbf)
Mechanical Life:	3,000,000 operations minimum
Operating Temperature Range:	-25°C through +50°C (-13°F through +122°F)

MATERIALS

Actuator: Polyacetal Housing: Polyamide

PHOTO INTERRUPTER SPECIFICATIONS

(Temperature @ 25°C)

Electrical & Optical Characteristics	Typical	Maximum	Condition
Input			
Forward Voltage V_F :	1.3V	1.6V	$I_F = 50\text{mA}$
Reverse Current I_R :		10 μ A	$F_R = 5\text{V}$
Transmission			
Collector-Emitter Saturation Voltage $V_{CE\text{ sat}}$:		0.4V	$I_F = 20\text{mA}$ & $I_C = 0.1\text{mA}$
Absolute Maximum Ratings			
Input LED	Output Photo Transistor		
Typical Forward Current I_F :	50mA	Collector-Emitter Voltage V_{CEO} :	30V
Reverse Voltage V_R :	5V	Emitter-Collector Voltage V_{ECO} :	4.5V
Power Dissipation P_D :	80mW	Collector Current I_C :	30mA
		Collector Dissipation P_C :	80mW

Circuit Design Considerations

Output of the infrared LED in the photo interrupter decreases approximately 50% after 100,000 hours. Recommended load resistance (RL) is 40k ~ 120k Ω for the illustrated circuit.

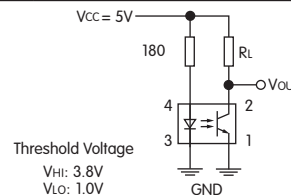

LED COLORS & SPECIFICATIONS

LEDs are an integral part of the switch and not available separately. The electrical specifications shown are determined at a basic temperature of 25°C.

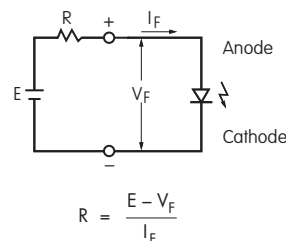

Where: R = Resistor Value (Ohms)
E = Source Voltage (V)
 V_F = Forward Voltage (V)
 I_F = Forward Current (A)

If the source voltage exceeds the rated voltage, a ballast resistor is required.

Single Element LED	Color	C Red	D Amber	F Green
Maximum Forward Current	I_{FM}	30mA	25mA	25mA
Typical Forward Current	I_F	20mA	20mA	20mA
Forward Voltage	V_F	1.85V	2.0V	2.25V
Maximum Reverse Voltage	V_{RM}	5V	5V	5V
Current Reduction Rate Above 25°C	ΔI_F	0.38mA /°C	0.28mA /°C	0.40mA /°C
Ambient Temperature Range		-25° ~ +50°C		

ACTUATOR COLORS



White



Red



Amber



Green

CONNECTOR OPTIONS



AT021
Assembled Connector
with Wire Leads

Connector body: JST model ZHR-6
Crimp connector pins: JST model SZH-002T-P0.5
Wire leads: 28-26AWG; 12-inch, unstripped;
Blue for Pin 1



AT022
Unassembled Connector
and Pins

1 connector and 8 crimp connector pins
only (no wire leads provided).

Matching wire leads: 28-26AWG

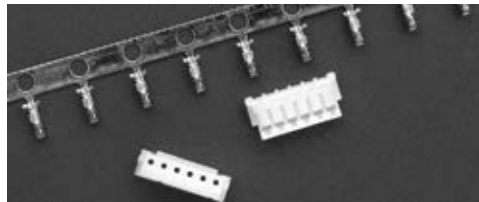

No Connector

Recommended connector
for assembly:
JST model number ZHR-6

Recommended crimp
connector pins:
JST model SZH-002T-P0.5
for 28-26AWG wire leads
or SZH-003T-P0.5
for 32-28AWG wire leads.

TYPICAL SWITCH DIMENSIONS

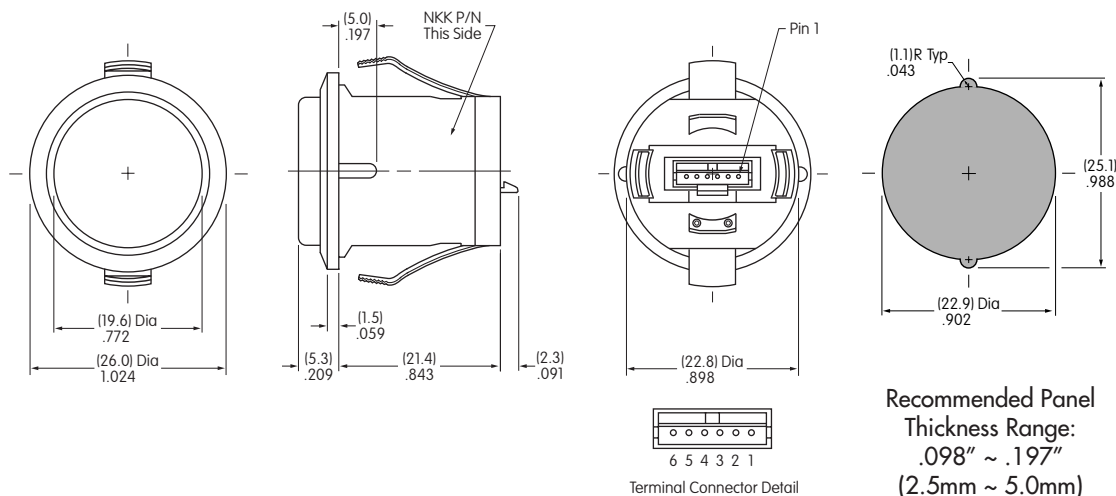

Recommended Panel
Thickness Range:
.098" ~ .197"
(2.5mm ~ 5.0mm)

FP0115CAC1FF

LEGENDS

NKK Switches can provide custom legends for caps. Contact factory for more information.

Suggested Printable Area for FP01 Cap



Recommended Methods:

Screen Print on cap.
Epoxy based ink is recommended.

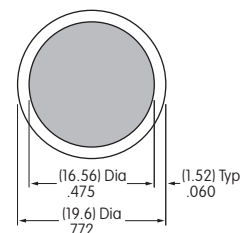

Shaded area is printable area.

Toggles
Rocker
Pushbuttons
Illuminated PB
Programmable
Keylocks
Rotaries
Slides
Tactiles
Tilt
Touch
Indicators
Accessories
Supplement