

EL - 316

The EL - 316 is a high - power GaAs IRED mounted in a clear epoxy package.

FEATURES

- $\varnothing 3$ casting mold type
- High output power

APPLICATIONS

- VTR
- Optical remote controllers
- Transmission sensors

DIMENSIONS

(Unit : mm)

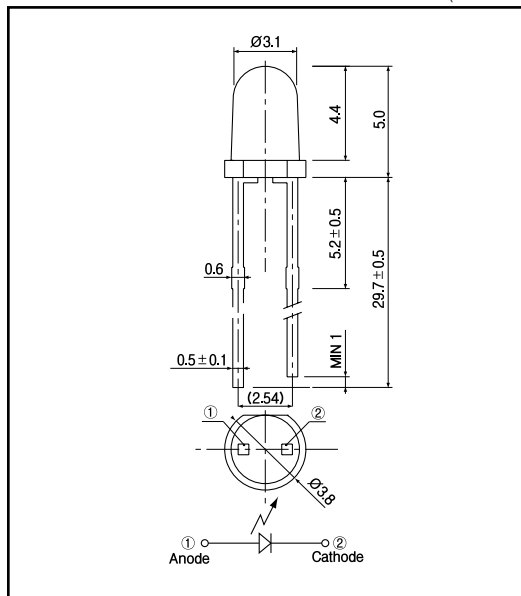

MAXIMUM RATINGS

($T_a=25$)

Item	Symbol	Rating	Unit
Reverse voltage	V_R	4	V
Forward current	I_F	60	mA
Power dissipation	P_o	80	mW
Pulse forward current ^{*1}	I_{FP}	0.5	A
Operating temp.	$T_{opr.}$	- 25 + 80	
Storage temp.	$T_{stg.}$	- 40 + 85	
Soldering temp. ^{*2}	$T_{sol.}$	240	

*1. pulse width : t_w 100 μ sec.period : $T=10$ msec.

*2. For MAX.5 seconds at the position of 2 mm from the package

ELECTRO-OPTICAL CHARACTERISTICS

($T_a=25$)

Item	Symbol	Conditions	Min.	Typ.	Max.	Unit.
Forward voltage	V_f	$I_f=40$ mA		1.2	1.5	V
Reverse current	I_r	$V_R=4$ V			10	μ A
Peak emission wavelength	λ_p	$I_f=40$ mA		940		nm
Spectral bandwidth		$I_f=40$ mA		50		nm
Radiant intensity	PO	$I_f=40$ mA	10	20		mW/sr
Half angle				± 17		deg.

Infrared Emitting Diodes(GaAs)

EL - 316

Power dissipation Vs. Ambient temperature

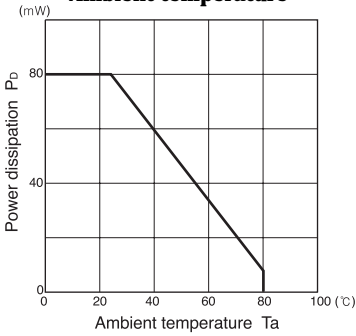

Radiant intensity Vs. Forward current

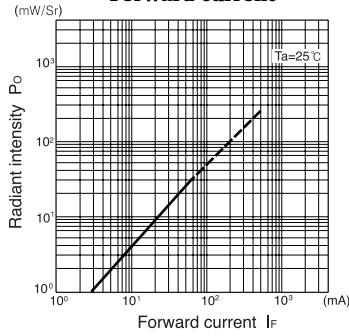

Relative radiant intensity Vs. Ambient temperature

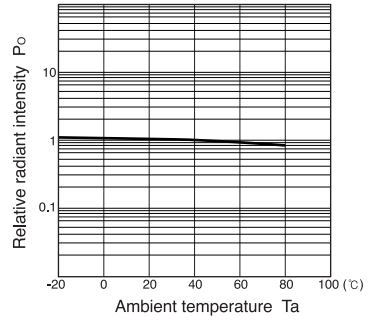

Relative intensity Vs. Wavelength

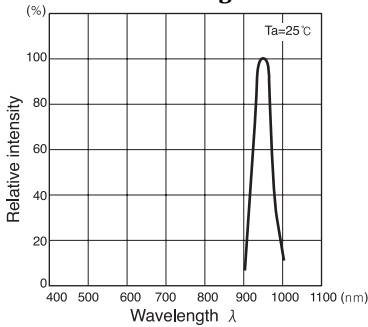

Forward current vs. Forward voltage

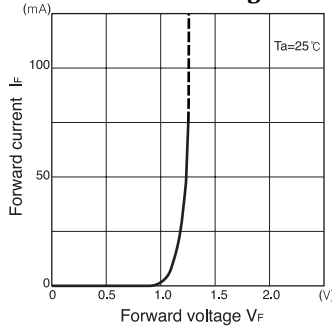

Radiant Pattern

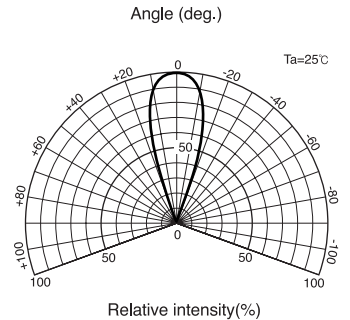

Relative radiant intensity Vs. Distance

