

ELECTRO-OPTICAL CHARACTERISTICS $T_A=25^{\circ}\text{C}$ $I_f=20\text{mA}$					
PARAMETER	MIN	TYP	MAX	UNITS	TEST COND
PEAK WAVELENGTH				nm	
FORWARD VOLTAGE	2.7		3.5	V_f	
REVERSE VOLTAGE	5.0			V_r	$I_f=100\mu\text{A}$
AXIAL INTENSITY	2250		4500	mcd	$I_f=20\text{mA}$
VIEWING ANGLE		120		$2x$ theta	
EMITTED COLOR:	WHITE				
EPOXY LENS FINISH:	WATER CLEAR LENS				

LIMITS OF SAFE OPERATION AT 25°C PER CHIP		
PARAMETER	MAX	UNITS
PEAK FORWARD CURRENT*	100	mA
STEADY CURRENT	30	mA
POWER DISSIPATION	110	mW
DERATE FROM 25°C	-1.2	mW/ $^{\circ}\text{C}$
OPERATING TEMP.	-40 TO +85	$^{\circ}\text{C}$
STORAGE TEMP.	-40 TO +85	$^{\circ}\text{C}$
SOLDERING TEMP.	+260	$^{\circ}\text{C}$
2.0mm FROM BODY	3	SEC. MAX

* $t < 10\mu\text{s}$

NOTES:

1. THE POLARITY MARK IS ORIENTED TOWARDS THE TAPE SPROCKET HOLE.
2. 2,000 PER REEL.

CAUTION: MOISTURE SENSITIVE DEVICE
PER JEDEC LEVEL 2 STANDARDS

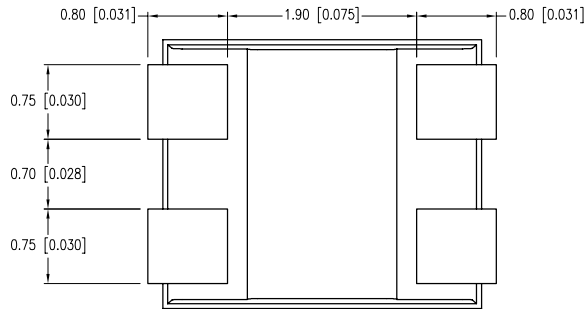
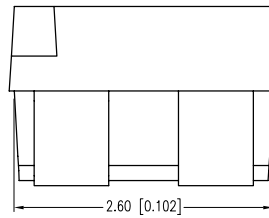
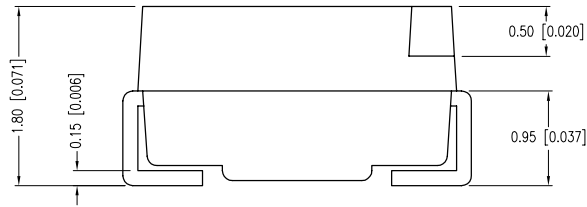

*UNLESS OTHERWISE SPECIFIED TOLERANCES PER DECIMAL PRECISION ARE: X= ± 1 (± 0.039), X.X= ± 0.5 (± 0.020), X.XX= ± 0.25 (± 0.010), X.XXX= ± 0.127 (± 0.005). LEAD SIZE= ± 0.05 (± 0.002), LEAD LENGTH= ± 0.75 (± 0.030). MIN= $\frac{+0.00}{-0.00}$ DECIMAL PRECISION MAX.= $\frac{+0.00}{-0.00}$ DECIMAL PRECISION UNCONTROLLED DOCUMENT



290 E. HELEN ROAD
PALATINE, IL 60067-6976
PHONE: +1.847.359.2790
FAX: +1.847.359.6538
WEB: WWW.LUMEX.COM

2.8mm x 3.2mm SML /W REFLECTOR CUP, DUAL CHIP, ULTRA WHITE LED, WATER CLEAR LENS, 2k PER REEL.

THE SPECIFICATIONS MAY CHANGE AT ANY TIME WITHOUT NOTICE DUE TO NEW MATERIALS OR PRODUCT IMPROVEMENT.

CONFIDENTIAL INFORMATION
THE INFORMATION CONTAINED IN THIS DOCUMENT IS THE PROPERTY OF LUMEX INC. EXCEPT AS SPECIFICALLY AUTHORIZED IN WRITING BY LUMEX INC., THE HOLDER OF THIS DOCUMENT SHALL KEEP ALL INFORMATION CONTAINED HEREIN CONFIDENTIAL AND SHALL PROTECT SAME IN WHOLE OR IN PART FROM DISCLOSURE AND DISSEMINATION TO ALL THIRD PARTIES.

DATE:	02.3.11	DRAWN BY:	AB
PAGE:	1 OF 3	CHKD BY:	KF
SCALE:	NTS	APRVD BY:	JD
UNIT:	mm [INCH]		(P6)

C.I.E. 1931 CHROMATICITY DIAGRAM

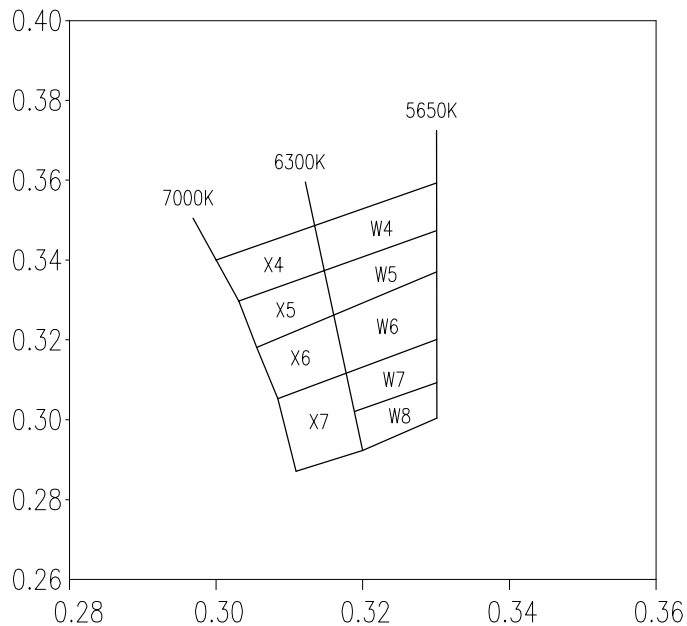

I_f = 20mA

CCT	BIN CODE	CIE_x	CIE_y
6300K ~7000K	X4	0.3010	0.3420
		0.3140	0.3550
		0.3150	0.3440
		0.3030	0.3330
	X5	0.3050	0.3220
		0.3030	0.3330
		0.3150	0.3440
		0.3160	0.3330
	X6	0.3080	0.3110
		0.3050	0.3220
		0.3160	0.3330
	X7	0.3170	0.3200
		0.3080	0.3110
		0.3170	0.3200
0.3190		0.3000	
		0.3110	0.2930

I_f = 20mA

CCT	BIN CODE	CIE_x	CIE_y
5650K ~6300K	W4	0.3290	0.3690
		0.3290	0.3570
		0.3150	0.3440
		0.3140	0.3550
	W5	0.3290	0.3450
		0.3160	0.3330
		0.3150	0.3440
		0.3290	0.3570
	W6	0.3290	0.3450
		0.3290	0.3310
		0.3170	0.3200
		0.3160	0.3330
	W7	0.3290	0.3310
		0.3290	0.3200
		0.3180	0.3100
		0.3170	0.3200
W8	0.3290	0.3200	
	0.3290	0.3100	
	0.3190	0.3000	
	0.3180	0.3100	

*UNLESS OTHERWISE SPECIFIED TOLERANCES PER DECIMAL PRECISION ARE: X=±1 (±0.039), X.X=±0.5 (±0.020), X.XX=±0.25 (±0.010), X.XXX=±0.127 (±0.005). LEAD SIZE=±0.05 (±0.002), LEAD LENGTH=±0.75 (±0.030). MIN.= +DECIMAL PRECISION MAX.= +0.00 -DECIMAL PRECISION UNCONTROLLED DOCUMENT



290 E. HELEN ROAD
PALATINE, IL 60067-6976
PHONE: +1.847.359.2790
FAX: +1.847.359.6538
WEB: WWW.LUMEX.COM

2.8mm x 3.2mm SML /W REFLECTOR CUP, DUAL CHIP, ULTRA WHITE LED, WATER CLEAR LENS, 2k PER REEL.

THE SPECIFICATIONS MAY CHANGE AT ANY TIME WITHOUT NOTICE DUE TO NEW MATERIALS OR PRODUCT IMPROVEMENT.

CONFIDENTIAL INFORMATION
THE INFORMATION CONTAINED IN THIS DOCUMENT IS THE PROPERTY OF LUMEX INC. EXCEPT AS SPECIFICALLY AUTHORIZED IN WRITING BY LUMEX INC., THE HOLDER OF THIS DOCUMENT SHALL KEEP ALL INFORMATION CONTAINED HEREIN CONFIDENTIAL AND SHALL PROTECT SAME IN WHOLE OR IN PART FROM DISCLOSURE AND DISSEMINATION TO ALL THIRD PARTIES.

DATE:	02.3.11	DRAWN BY:	AB
PAGE:	2 OF 3	CHKD BY:	KF
SCALE:	NTS	APRVD BY:	JD
UNIT:	mm [INCH]		Ⓟ

LEAD FREE REFLOW PROFILE

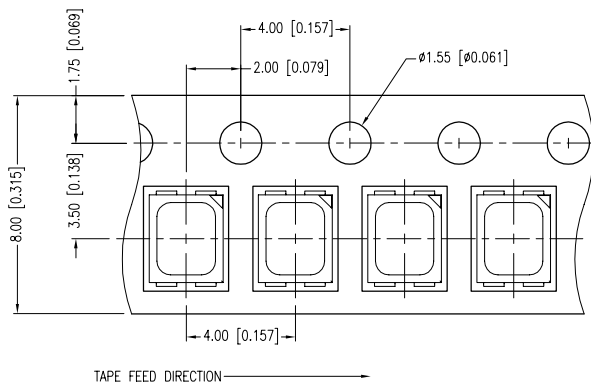
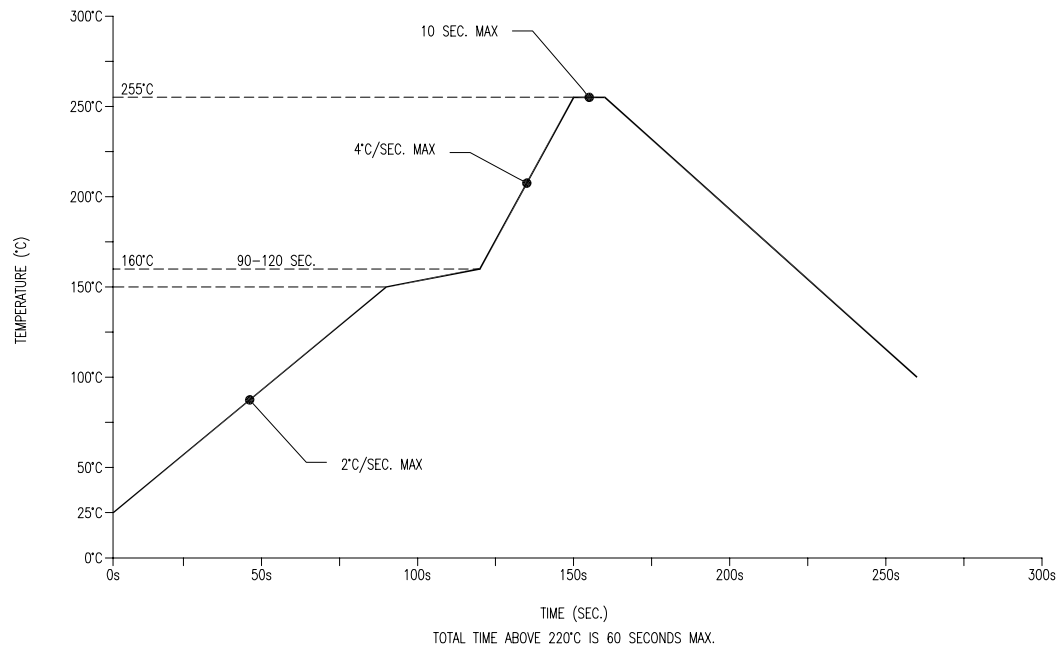

RECOMMENDED SOLDER PAD LAYOUT

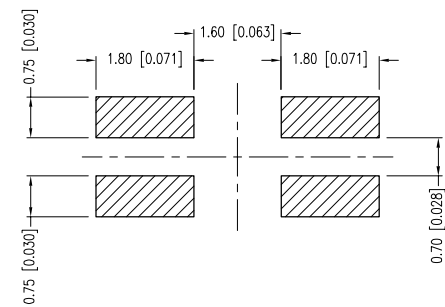

*UNLESS OTHERWISE SPECIFIED TOLERANCES PER DECIMAL PRECISION ARE: X=±1 (±0.039), X.X=±0.5 (±0.020), X.XX=±0.25 (±0.010), X.XXX=±0.127 (±0.005). LEAD SIZE=±0.05 (±0.002), LEAD LENGTH=±0.75 (±0.030). MIN= +DECIMAL PRECISION MAX.= +0.00 -DECIMAL PRECISION UNCONTROLLED DOCUMENT



290 E. HELEN ROAD
PALATINE, IL 60067-6976
PHONE: +1.847.359.2790
FAX: +1.847.359.6538
WEB: WWW.LUMEX.COM

2.8mm x 3.2mm SML /W REFLECTOR CUP, DUAL CHIP, ULTRA WHITE LED, WATER CLEAR LENS, 2k PER REEL.

THE SPECIFICATIONS MAY CHANGE AT ANY TIME WITHOUT NOTICE DUE TO NEW MATERIALS OR PRODUCT IMPROVEMENT.

CONFIDENTIAL INFORMATION
THE INFORMATION CONTAINED IN THIS DOCUMENT IS THE PROPERTY OF LUMEX INC. EXCEPT AS SPECIFICALLY AUTHORIZED IN WRITING BY LUMEX INC., THE HOLDER OF THIS DOCUMENT SHALL KEEP ALL INFORMATION CONTAINED HEREIN CONFIDENTIAL AND SHALL PROTECT SAME IN WHOLE OR IN PART FROM DISCLOSURE AND DISSEMINATION TO ALL THIRD PARTIES.

DATE:	02.3.11	DRAWN BY:	AB
PAGE:	3 OF 3	CHKD BY:	KF
SCALE:	NTS	APRVD BY:	JD
UNIT:	mm [INCH]		Ⓟ