

#### DESCRIPTION:

The KW1-2301 series is large single digit display in 2.30 inch (58.90mm) height with right DP designed for accurate readable displays need to be viewed over a distance.

This series is suitable for use in instruments, digital readout displays.

All devices are available as either common anode or common cathode.

#### ABSOLUTE MAXIMUM RATINGS: (Ta=25°C)

Parameter	Max
Reverse Voltage per segment	5 V
Reverse Current per segment (Vr = 5V)	100μA
Derating Linear from 25°C per segment	0.4mA/°C
Operating Temperature Range	-40°C To 85°C
Storage Temperature Range	-40°C To 100°C
Soldering Temperature 1.6mm(1/16") from body for 5 sec. at 260°C	

- NOTES : 1. All dimensions are in millimeters (inches).  
 2. Tolerance is ±0.25mm(0.010) unless otherwise specified.  
 3. Specifications are subject to change without notice.  
 4. NP: No Pin.  
 5. NC: No Connect.

#### TESTING CONDITION FOR EACH PARAMETER :

Parameter	Symbol	Unit	Test Condition
Forward Voltage	Vf	V	If=20mA
Peak Emission Wave Length	λp	nm	If=20mA
Spectral Line Half-Width	Δλ	nm	If=20mA
Reverse Current	Ir	μA	Vr=5V
Average Luminous Intensity	Iv	μ cd	If=10mA

#### PACKAGE DIMENSIONS

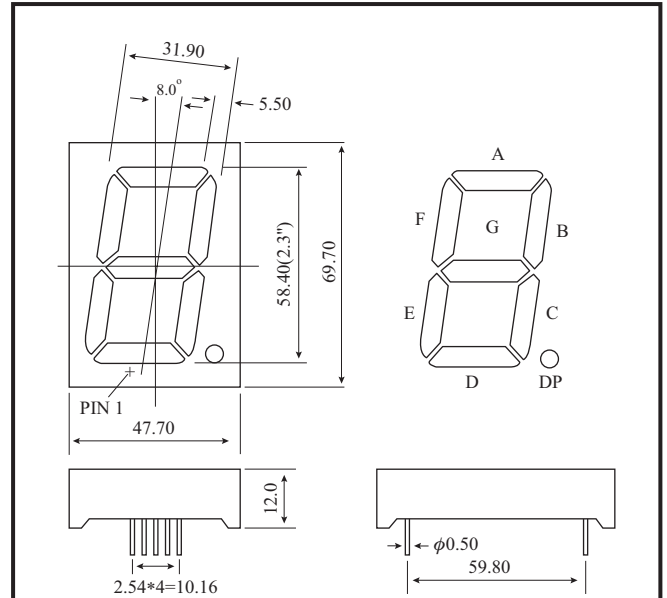

#### INTERNAL CIRCUIT DIAGRAM

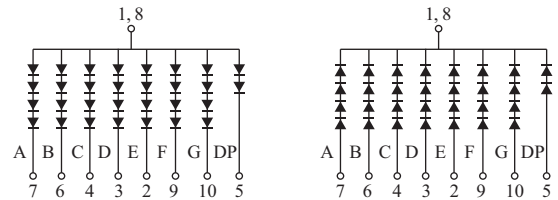

#### PART NO. SELECTION AND APPLICATION INFORMATION (RATINGS AT 25°C AMBIENT)

Part No.	Chip		C.C or C.A	Wave Length λp (nm)	Absolute Maximum Ratings				Electro-optical Data(at 10mA)					
	Raw Material	Emitted Color			Δλ (nm)	Pd (mW)	If (mA)	If (Peak) (mA)	Vf (V) Per Segment			If (Rec) (mA)	Iv (μcd) Per Segment	
									Min.	Typ.	Max.		Min.	Typ.
KW1-2301A3	GaAsP/GaP	Hi-Eff. Red	Common Anode	635	45	100	50	100	6.8	8.0	10	10-20	2000	6000
KW1-2301AS	GaAlAs	Super Red		660	20	100	50	100	6.4	7.5	8.0	10-20	12000	42000
KW1-2301A2	GaP	Green		565	30	100	50	100	6.8	8.4	10	10-20	1800	5400
KW1-2301AG	GaP	Super Green		570	30	100	50	100	6.8	8.4	10	10-20	2000	5700
KW1-2301A6	GaAsP/GaP	Yellow		585	30	100	50	100	6.8	8.4	10	10-20	1800	5400
KW1-2301C3	GaAsP/GaP	Hi-Eff Red	Common Cathode	635	45	100	50	100	6.8	8.0	10	10-20	2000	6000
KW1-2301CS	GaAlAs	Super Red		660	20	100	50	100	6.4	7.5	8.0	10-20	12000	42000
KW1-2301C2	GaP	Green		565	30	100	50	100	6.8	8.4	10	10-20	1800	5400
KW1-2301CG	GaP	Super Green		570	30	100	50	100	6.8	8.4	10	10-20	2000	5700
KW1-2301C6	GaAsP/GaP	Yellow		585	30	100	50	100	6.8	8.4	10	10-20	1800	5400

- REMARKS : 1. The average luminous intensity is obtained by summing the luminous intensity of each segment and dividing by the total number of segments.  
 2. Luminous intensity is measured with a light sensor and filter combination that approximates the CIE (International Commission on Illumination) eye-response curve.  
 3. Clean only by pure water, isopropanol, ethanol, Freon TF (or equivalent).