

NJG1704V

■ABSOLUTE MAXIMUM RATINGS

($T_a=+25^{\circ}\text{C}$, $Z_s=Z_i=50\Omega$)

PARAMETER	SYMBOL	CONDITIONS	RATINGS	UNITS
LNA Voltage	V_{LNA}		5.0	V
MIXER Voltage	V_{MIX}		5.0	V
LOCAL Amplifier Voltage	V_{LO}		5.0	V
Input Power 1	P_{LNAIN}	$V_{LNA}=V_{MIX}=V_{LO}=2.7V$	+15	dBm
Input Power 2	P_{LOIN}	$V_{LNA}=V_{MIX}=V_{LO}=2.7V$	+10	dBm
Power Dissipation	P_D		320	mW
Operating Temperature	T_{opr}		-40~+85	$^{\circ}\text{C}$
Storage Temperature	T_{stg}		-55~+125	$^{\circ}\text{C}$

■ELECTRICAL CHARACTERISTICS

COMMON CONDITIONS: $T_a=+25^{\circ}\text{C}$, $V_{LNA}=V_{MIX}=V_{LO}=2.7V$, $f_{RF}=820\text{MHz}$, $f_{LO}=690\text{MHz}$, $P_{RF}=-50\text{dBm}$, $P_{LO}=-10\text{dBm}$, $Z_s=Z_i=50\Omega$, Application Circuit, $f_{LO}=690\text{MHz}$

PARAMETER	SYMBOL	CONDITIONS	MIN	TYP	MAX	UNITS
Operating Frequency	Freq		800	820	900	MHz
LNA Voltage	V_{LNA}		2.5	2.7	4.5	V
MIXER Voltage	V_{MIX}		2.5	2.7	4.5	V
LOCAL Amplifier Voltage	V_{LO}		2.5	2.7	4.5	V
LNA Current	I_{LNA}	$P_{RF}, P_{LO}=\text{OFF}$	-	3.0	4.5	mA
MIXER Current	I_{MIX}	$P_{RF}, P_{LO}=\text{OFF}$	-	5.0	6.7	mA
LOCAL Amplifier Current	I_{LO}	$P_{RF}, P_{LO}=\text{OFF}$	-	1.0	2.0	mA
Total Current	I_{AL}	$P_{RF}, P_{LO}=\text{OFF}$	-	9.0	13.2	mA
Conversion Gain	G_c		25.0	28.0	-	dB
Gain Flatness	G_{flat}	30MHz bandwidth in $f_{RF}=810\sim 885\text{MHz}$	-	1.5	-	dB
Noise Figure	NF		-	1.7	2.0	dB
1dB Gain Compression Output Power	P-1dB		-1.0	+2.5	-	dBm
Input 3rd Intercept Point	IIP3	$f_{RF}=820.0+820.1\text{MHz}$	-19.0	-14.0	-	dBm
Image Suppression Level	IMR		-	-22.0	-18.0	dBc
RF IN VSWR	$VSWR_i$		-	2.0	3.0	

■ ELECTRICAL CHARACTERISTICS (LNA)

COMMON CONDITIONS: $T_a=+25^{\circ}\text{C}$, $V_{\text{LNA}}=2.7\text{V}$, $V_{\text{MIX}}=V_{\text{LO}}=0\text{V}$, $f_{\text{RF}}=820\text{MHz}$, $Z_s=Z_i=50\Omega$
 Application Circuit, $f_{\text{LO}}=690\text{MHz}$

PARAMETER	SYMBOL	CONDITIONS	MIN	TYP	MAX	UNITS
Small Signal Gain	Gain		-	16.0	-	dB
Noise Figure	NF		-	1.4	-	dB
Input 3'rd Intercept Point	IIP3	$f_{\text{RF}}=820.0+820.1\text{MHz}$	-	-3.0	-	dBm
RF IN VSWR	VSWR_i		-	2.0	-	
RF OUT VSWR	VSWR_o		-	2.0	-	

■ ELECTRICAL CHARACTERISTICS (MIXER)

COMMON CONDITIONS: $T_a=+25^{\circ}\text{C}$, $V_{\text{LNA}}=0\text{V}$, $V_{\text{MIX}}=V_{\text{LO}}=2.7\text{V}$, $f_{\text{RF}}=820\text{MHz}$, $f_{\text{LO}}=690\text{MHz}$,
 $P_{\text{RF}}=-30\text{dBm}$, $P_{\text{LO}}=-10\text{dBm}$, $Z_s=Z_i=50\Omega$ Application Circuit, $f_{\text{LO}}=690\text{MHz}$

PARAMETER	SYMBOL	CONDITIONS	MIN	TYP	MAX	UNITS
Conversion Gain	G_c		-	12.0	-	dB
Noise Figure	NF		-	5.0	-	dB
Input 3'rd Intercept Point	IIP3	$f_{\text{RF}}=820.0+820.1\text{MHz}$	-	+2.0	-	dBm

■TERMINAL INFORMATION

No.	SYMBOL	DESCRIPTIONS
1	LNAIN	RF input terminal of LNA. The RF signal is input through external matching circuit.
2	LNACAP	Terminal for the bypass capacitor of LNA. The bypass capacitor C1 shown in application circuit, should be connected to this terminal as close as possible.
3	GND	Ground terminal(0V)
4	IFOUT	IF signal output terminal. The IF signal is output though external matching circuit's connected to this terminal. Please connect inductance L8 and power supply as application circuit since it is also the terminal of Mixer power supply.
5	VLO	Power supply terminal for local amplifier. Please connect R1 and L10 to this terminal shown in the application circuit as close as possible.
6	LOIN	Local signal input terminal of local amplifier. The local signal input to Local Amplifier through external matching circuit.
7	GND	Ground terminal(0V)
8	MIXIN	RF signal input terminal of Mixer. The RF signal from LNA is sent to Mixer through matching circuit.
9	GND	Ground terminal(0V)
10	LNAOUT	Signal output terminal of LNA. The RF signal from LNA is output through external matching circuit connected to this terminal. Please connect inductance L4 and power supply shown in application circuit, since it is also the terminal of LNA power supply.

CAUTION

- 1) Ground terminal (No.3, 7, 9) should be connected to the ground plane as short as possible.

■ TYPICAL CHARACTERISTICS (LNA+MIXER, $f_{LO}=690\text{MHz}$)

Conversion Gain , Noise Figure vs. RF Frequency

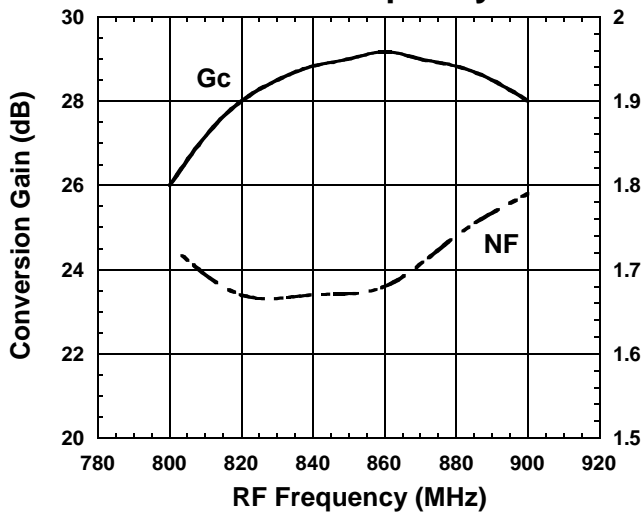

Condition
 $f_{IF}=130\text{MHz}$
 $P_{RF}=-46\text{dBm}$
 $P_{LO}=-10\text{dBm}$
 $V_{LNA}=V_{MIX}=V_{LO}=2.7\text{V}$

Conversion Gain , Noise Figure vs. LO Power

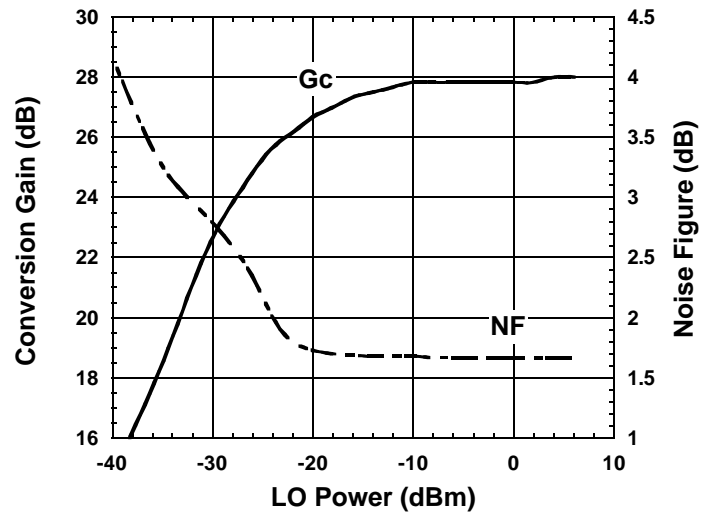

Condition
 $f_{IF}=130\text{MHz}$
 $f_{RF}=820\text{MHz}$, $P_{RF}=-46\text{dBm}$
 $f_{LO}=690\text{MHz}$
 $V_{LNA}=V_{MIX}=V_{LO}=2.7\text{V}$

Output-IP3 , Input-IP3 vs. LO Power

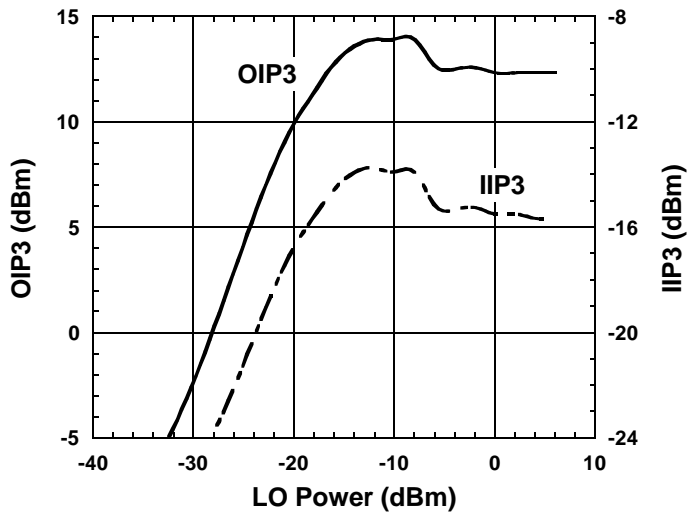

Condition
 $f_{IF}=130\text{MHz}$
 $f_{RF1}=820.0\text{MHz}$, $P_{RF}=-42\text{dBm}$
 $f_{RF2}=820.1\text{MHz}$
 $f_{LO}=690\text{MHz}$
 $V_{LNA}=V_{MIX}=V_{LO}=2.7\text{V}$

$$OIP3 = \frac{3IF-IM3}{2}$$

$$IIP3 = \frac{3IF-IM3}{2} - G_c$$

@ $P_{RF}=-42\text{dBm}$

NJG1704V

■ TYPICAL CHARACTERISTICS (LNA+MIXER, $f_{LO}=690\text{MHz}$)

RF IN IMPEDANCE

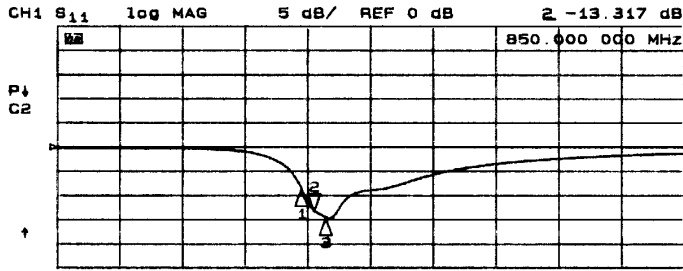

C2 MARKER 2
850 MHz

START 50.000 000 MHz STOP 2 000.000 000 MHz

Condition
V_{LNA}=2.7V
V_{MIX}=V_{LO}=2.7V
Marker1: 810MHz
Marker2: 850MHz
Marker3: 885MHz

LOCAL IN IMPEDANCE

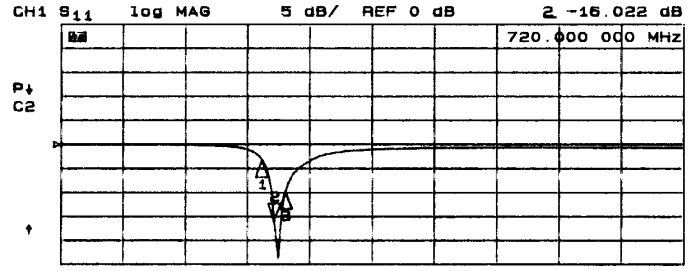

C2 MARKER 2
720 MHz

START 50.000 000 MHz STOP 2 000.000 000 MHz

Condition
V_{LNA}=2.7V
V_{MIX}=V_{LO}=2.7V
Marker1: 680MHz
Marker2: 720MHz
Marker3: 755MHz

IF OUT IMPEDANCE

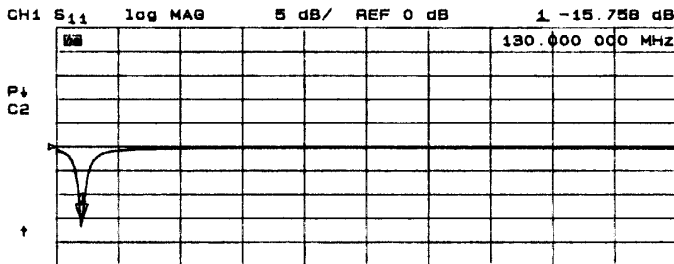

C2 MARKER 1
130 MHz

START 50.000 000 MHz STOP 2 000.000 000 MHz

Condition
V_{LNA}=2.7V
V_{MIX}=V_{LO}=2.7V

■ TYPICAL CHARACTERISTICS (LNA+MIXER, $f_{LO}=690\text{MHz}$)

Conversion Gain , Noise Figure vs. V_{LNA}, V_{MIX}, V_{LO}

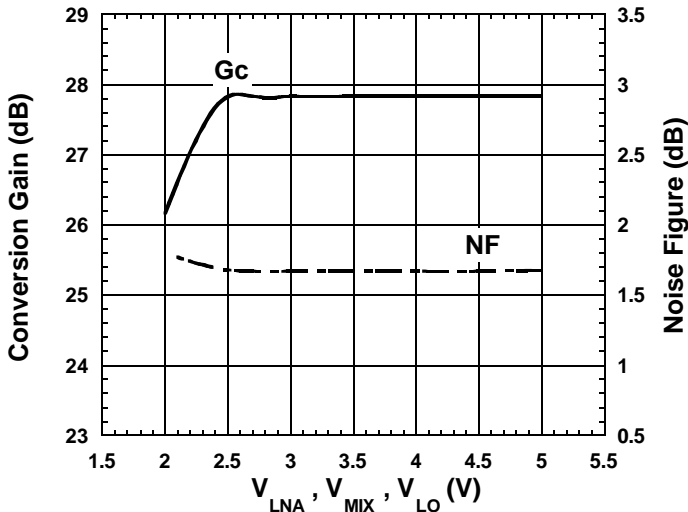

Condition
 $f_{IF}=130\text{MHz}$
 $f_{RF}=820\text{MHz}, P_{RF}=-46\text{dBm}$
 $f_{LO}=690\text{MHz}, P_{LO}=-10\text{dBm}$

Output-IP3 , Input-IP3 vs. V_{LNA}, V_{MIX}, V_{LO}

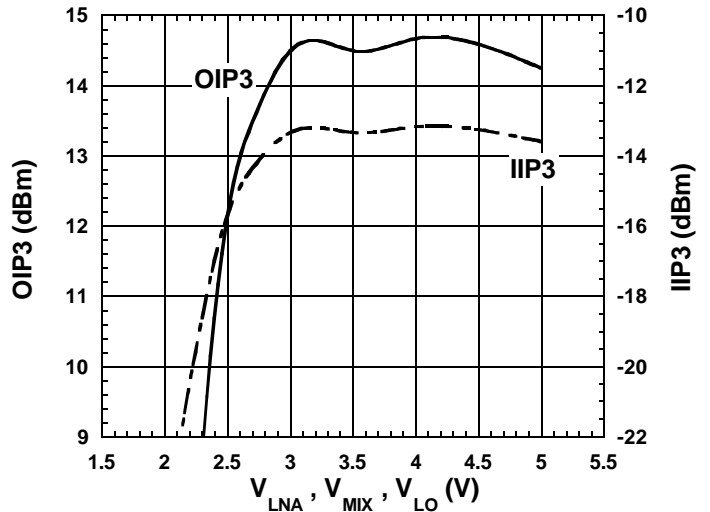

Condition
 $f_{IF}=130\text{MHz}$
 $f_{RF1}=820.0\text{MHz}, P_{RF}=-42\text{dBm}$
 $f_{RF2}=820.1\text{MHz}$
 $f_{LO}=690\text{MHz}, P_{LO}=-10\text{dBm}$

$$OIP3 = \frac{3IF - IM3}{2}$$

$$IIP3 = \frac{3IF - IM3}{2} - G_c$$

@ $P_{RF} = -42\text{dBm}$

IF , IM3 vs. RF Power

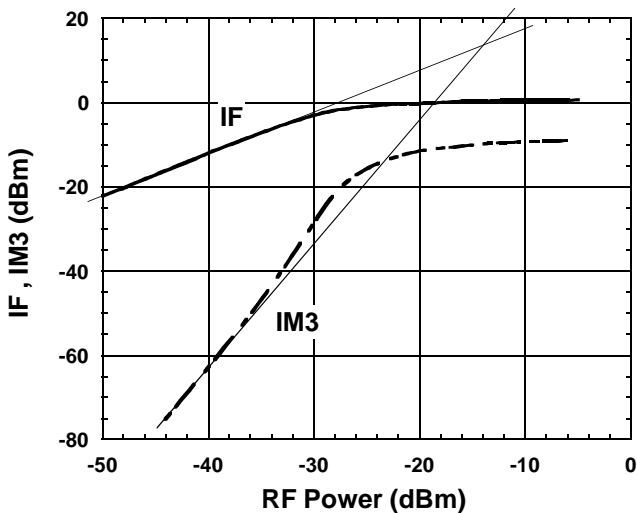

Condition
 $f_{IF}=130\text{MHz}$
 $f_{RF1}=820.0\text{MHz}$
 $f_{RF2}=820.1\text{MHz}$
 $f_{LO}=690\text{MHz}, P_{LO}=-10\text{dBm}$
 $V_{LNA}=V_{MIX}=V_{LO}=2.7\text{V}$

IF vs. RF Power

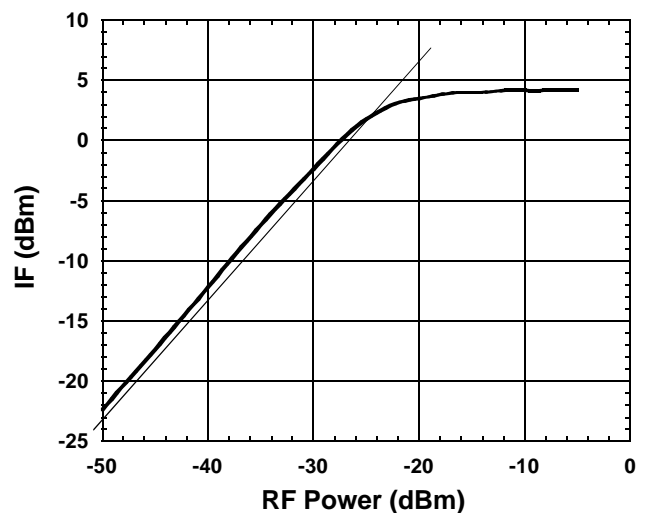

Condition
 $f_{IF}=130\text{MHz}$
 $f_{RF}=820\text{MHz}$
 $f_{LO}=690\text{MHz}, P_{LO}=-10\text{dBm}$
 $V_{LNA}=V_{MIX}=V_{LO}=2.7\text{V}$

NJG1704V

■ TYPICAL CHARACTERISTICS (LNA+MIXER, $f_{LO}=690\text{MHz}$)

Conversion Gain , Noise Figure vs. Temperature

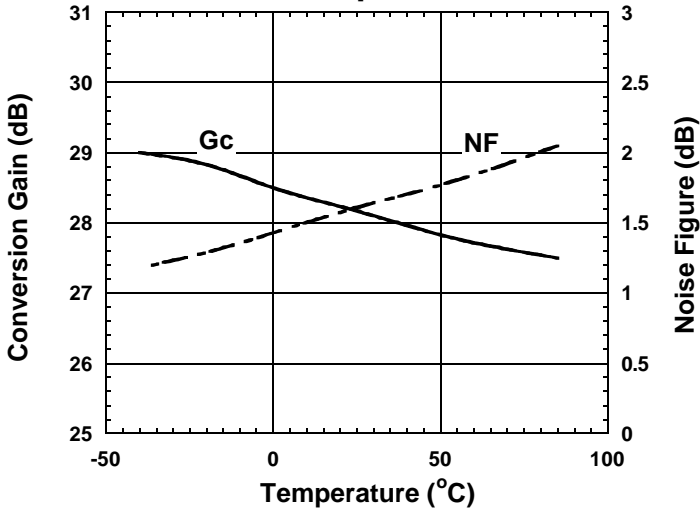

Condition
 $f_{IF}=130\text{MHz}$
 $f_{RF}=820\text{MHz}$, $P_{RF}=-46\text{dBm}$
 $f_{LO}=690\text{MHz}$, $P_{LO}=-10\text{dBm}$
 $V_{LNA}=V_{MIX}=V_{LO}=2.7\text{V}$

Output-IP3 , Input-IP3 vs. Temperature

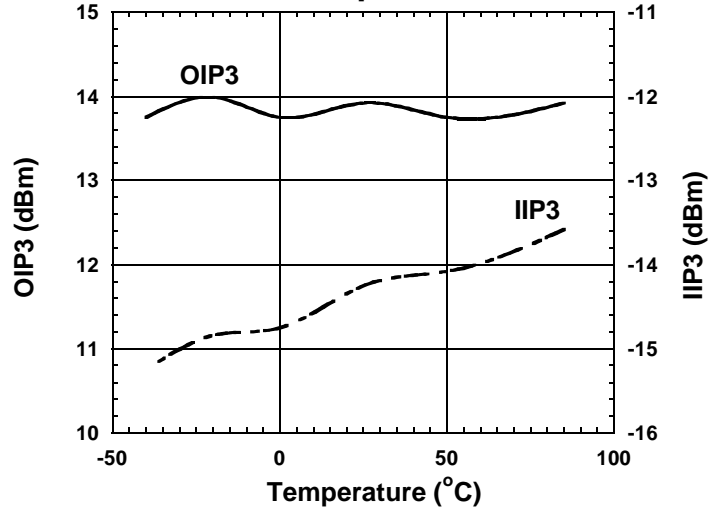

Condition
 $f_{IF}=130\text{MHz}$
 $f_{RF1}=820.0\text{MHz}$, $P_{RF}=-42\text{dBm}$
 $f_{RF2}=820.1\text{MHz}$
 $f_{LO}=690\text{MHz}$
 $V_{LNA}=V_{MIX}=V_{LO}=2.7\text{V}$

$$OIP3 = \frac{3IF-IM3}{2}$$

$$IIP3 = \frac{3IF-IM3}{2} - G_c$$

@ $P_{RF}=-42\text{dBm}$

I_{LNA} , I_{MIX} , I_{LO} vs. Temperature

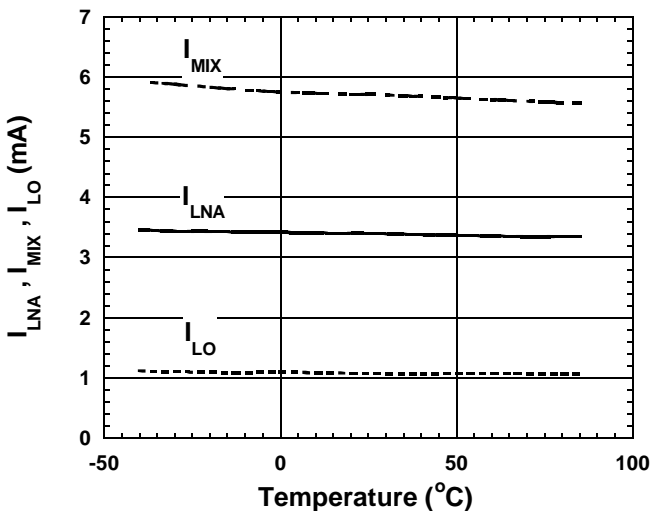

Condition
 $P_{RF}=\text{OFF}$
 $P_{LO}=\text{OFF}$
 $V_{LNA}=V_{MIX}=V_{LO}=2.7\text{V}$

■ TYPICAL CHARACTERISTICS (LNA+MIXER, $f_{LO}=690\text{MHz}$)

RF IN - LOCAL IN ISOLATION (RF IN-LOCAL IN)

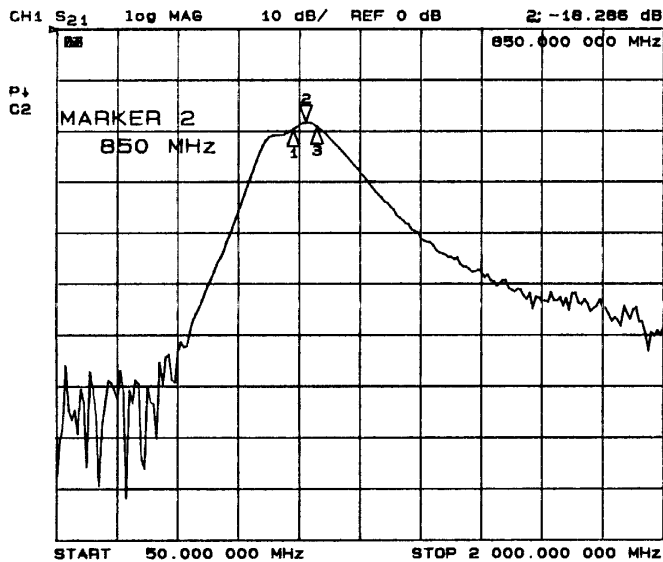

Condition
 $V_{LNA}=2.7\text{V}$ Marker1: 810MHz
 $V_{MIX}=V_{LO}=2.7\text{V}$ Marker2: 850MHz
 Port1: RF IN Marker3: 885MHz
 Port2: LOCAL IN

RF OUT - MIXER IN ISOLATION (RF OUT-MIXER IN)

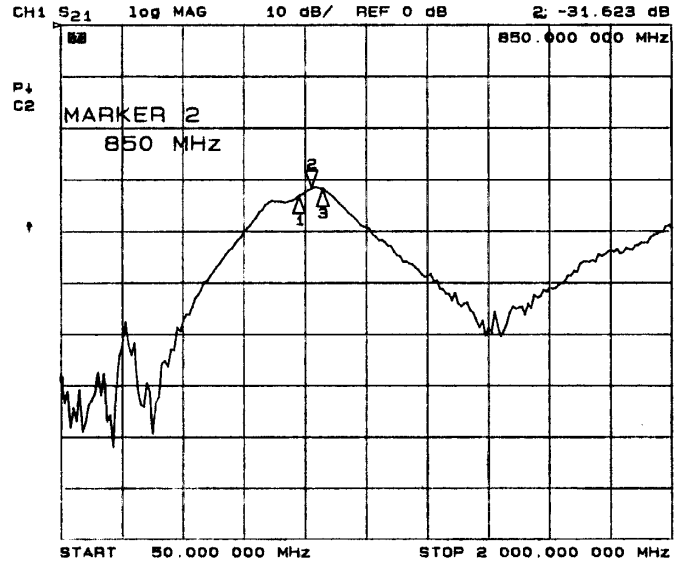

Condition
 $V_{LNA}=2.7\text{V}$ Marker1: 810MHz
 $V_{MIX}=V_{LO}=2.7\text{V}$ Marker2: 850MHz
 Port1: RF OUT Marker3: 885MHz
 Port2: MIXER IN

■ TYPICAL CHARACTERISTICS (LNA+MIXER $f_{LO}=1016.7\text{MHz}$)

Conversion Gain , Noise Figure vs. RF Frequency

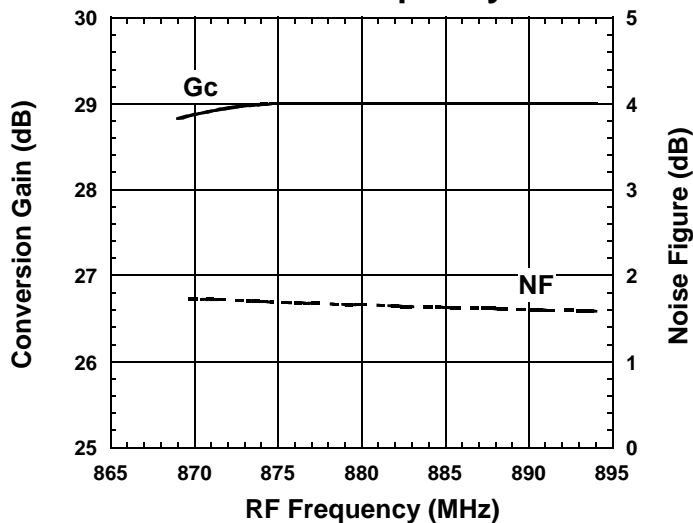

Condition
 $f_{IF}=135.2\text{MHz}$
 $P_{RF}=-50\text{dBm}$
 $P_{LO}=-8\text{dBm}$
 $V_{LNA}=V_{MIX}=V_{LO}=3.0\text{V}$
 Upper LOCAL

IF , IM3 vs. RF Power

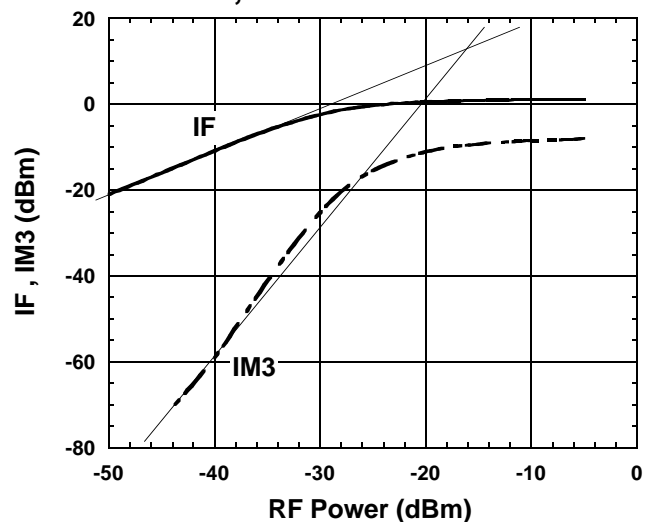

Condition
 $f_{IF}=135.2\text{MHz}$
 $f_{RF1}=881.5\text{MHz}$
 $f_{RF2}=881.6\text{MHz}$
 $f_{LO}=1016.7\text{MHz}, P_{LO}=-8\text{dBm}$
 $V_{LNA}=V_{MIX}=V_{LO}=3.0\text{V}$

NJG1704V

TYPICAL CHARACTERISTICS (LNA)

SMALL SIGNAL GAIN (S21)

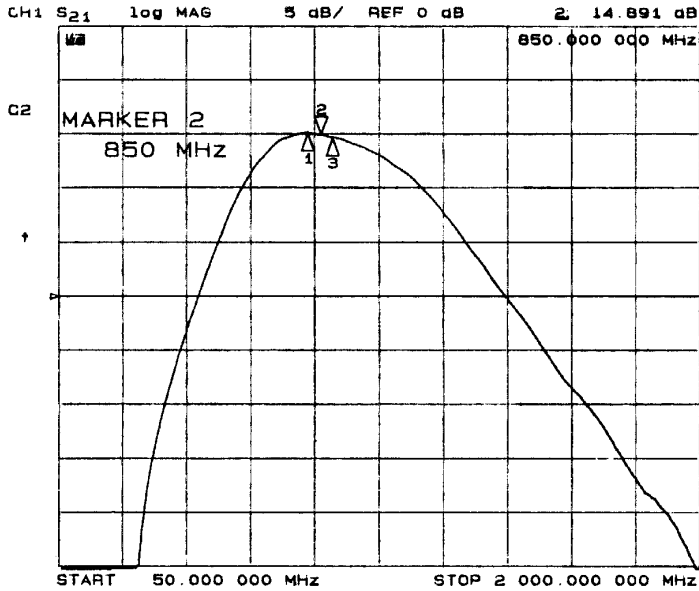

Condition
V_{LNA}=2.7V
V_{MIX}=V_{LO}=0V

Marker1:810MHz
Marker2:850MHz
Marker3:885MHz

RF IN RETURN LOSS (S11)

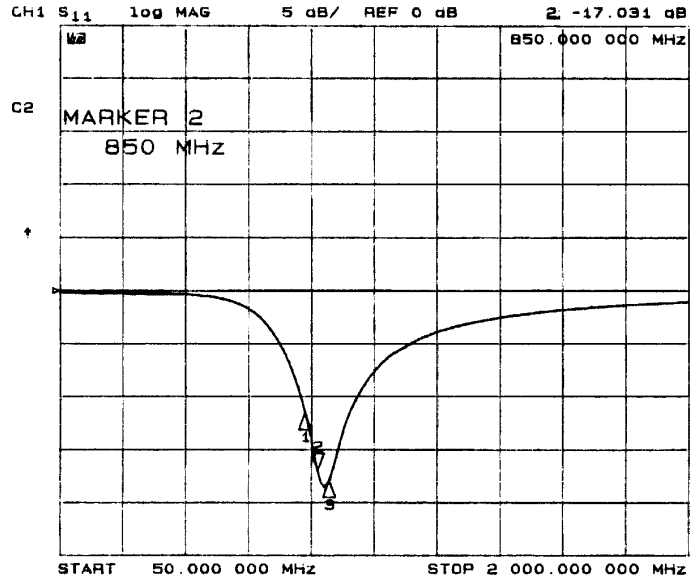

Condition
V_{LNA}=2.7V
V_{MIX}=V_{LO}=0V

Marker1:810MHz
Marker2:850MHz
Marker3:885MHz

RF OUT RETURN LOSS (S22)

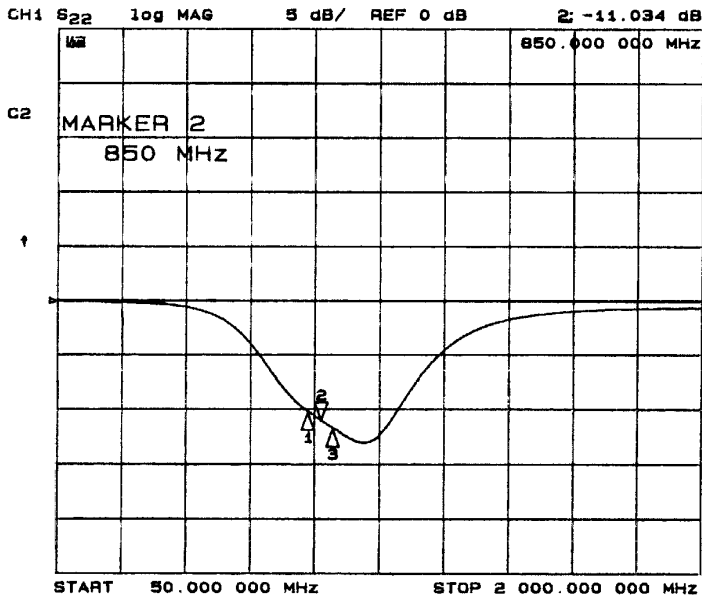

Condition
V_{LNA}=2.7V
V_{MIX}=V_{LO}=0V

Marker1:810MHz
Marker2:850MHz
Marker3:885MHz

ISOLATION (S12)

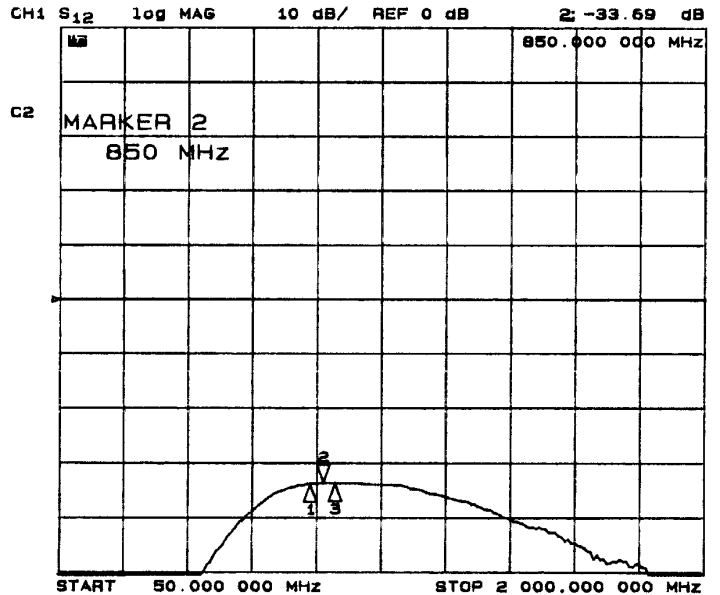

Condition
V_{LNA}=2.7V
V_{MIX}=V_{LO}=0V

Marker1:810MHz
Marker2:850MHz
Marker3:885MHz

■ TYPICAL CHARACTERISTICS (LNA)

Noise Figure vs. RF Frequency

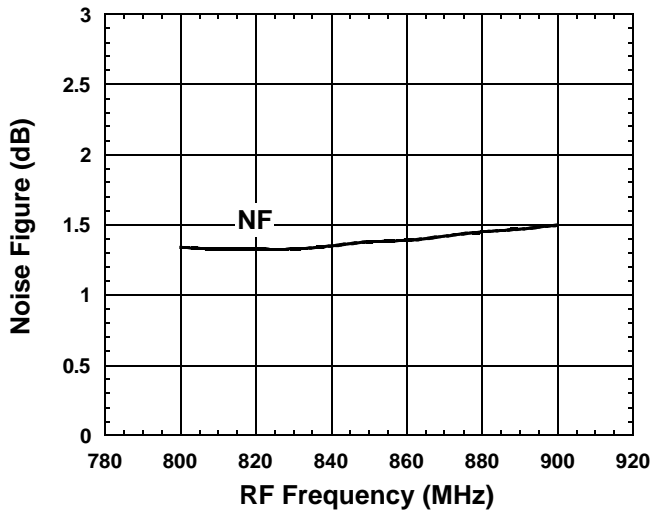

Condition
 $V_{LNA}=2.7V$
 $V_{MIX}=V_{LO}=0V$

Pout, IM3 vs. RF Power

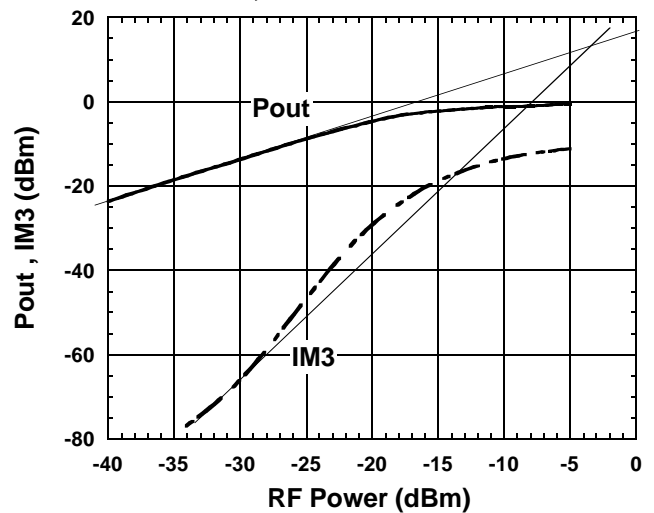

Condition
 $f_{RF}=820.0+820.1MHz$
 $V_{LNA}=2.7V$
 $V_{MIX}=V_{LO}=0V$

■ TYPICAL CHARACTERISTICS (MIXER)

Conversion Gain, Noise Figure vs. RF Frequency

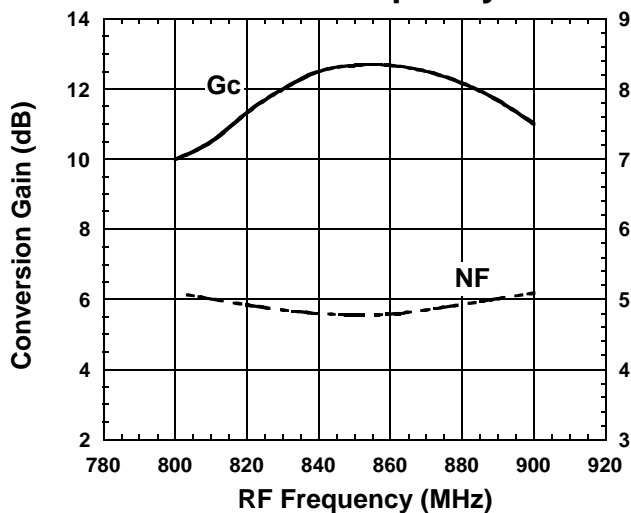

Condition
 $f_{IF}=130MHz$
 $P_{RF}=-30dBm$
 $P_{LO}=-10dBm$
 $V_{LNA}=0V$
 $V_{MIX}=V_{LO}=2.7V$

IF, IM3 vs. RF Power

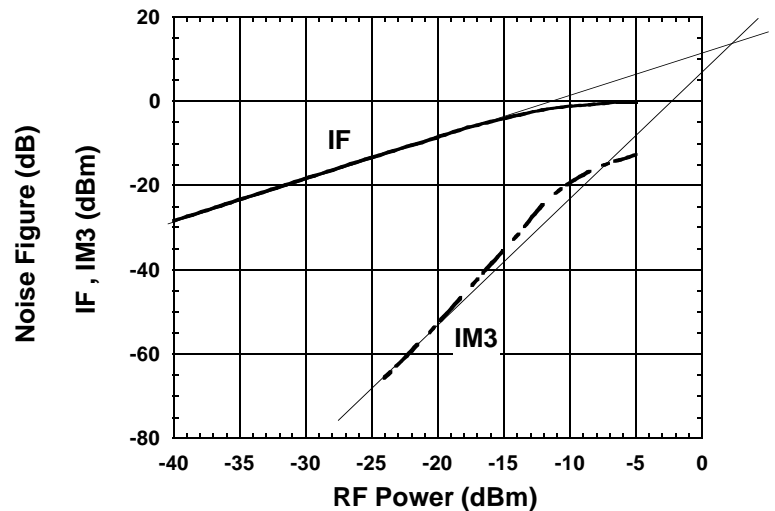

Condition
 $f_{IF}=130MHz$
 $f_{RF}=820MHz, P_{RF}=-30dBm$
 $f_{LO}=690MHz$
 $V_{LNA}=0V$
 $V_{MIX}=V_{LO}=2.7V$

NJG1704V

■ TYPICAL CHARACTERISTICS (MIXER, $f_{LO}=690\text{MHz}$)

MIXER IN IMPEDANCE

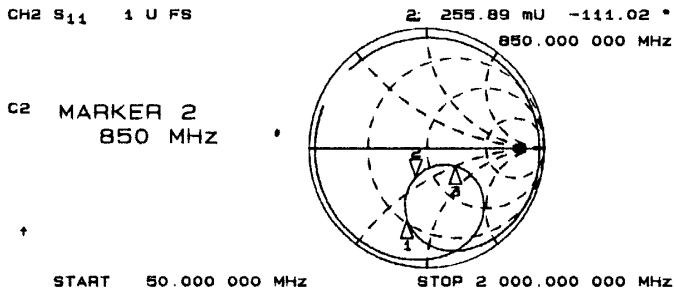
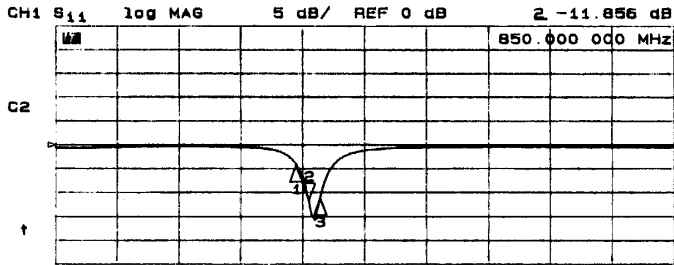

Condition
 $V_{LNA}=0\text{V}$
 $V_{MIX}=V_{LO}=2.7\text{V}$
 Marker1:810MHz
 Marker2:850MHz
 Marker3:885MHz

LOCAL IN IMPEDANCE

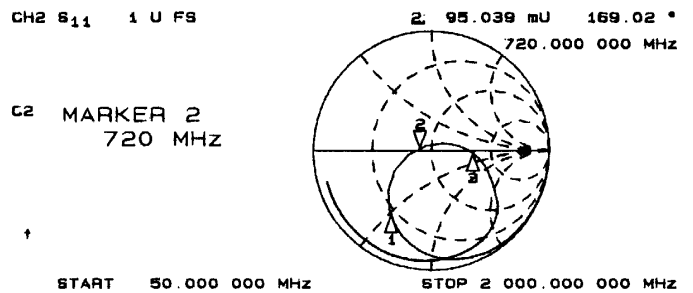
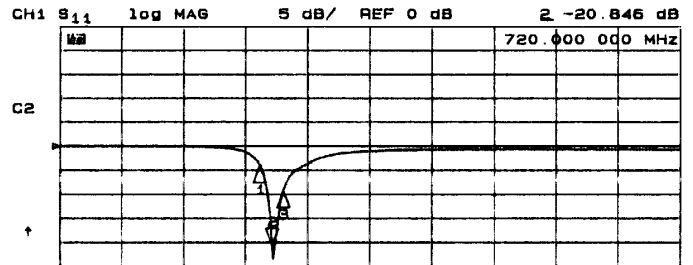

Condition
 $V_{LNA}=0\text{V}$
 $V_{MIX}=V_{LO}=2.7\text{V}$
 Marker1:680MHz
 Marker2:720MHz
 Marker3:755MHz

IF OUT IMPEDANCE

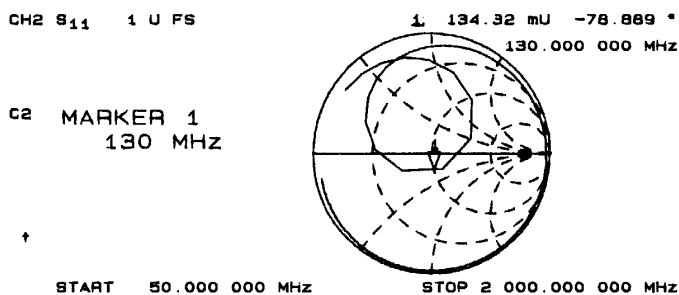
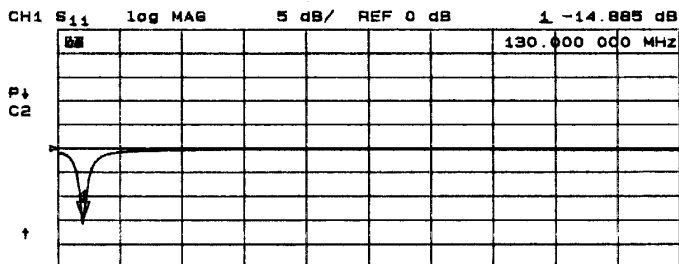

Condition
 $V_{LNA}=0\text{V}$
 $V_{MIX}=V_{LO}=2.7\text{V}$

APPLICATION CIRCUIT

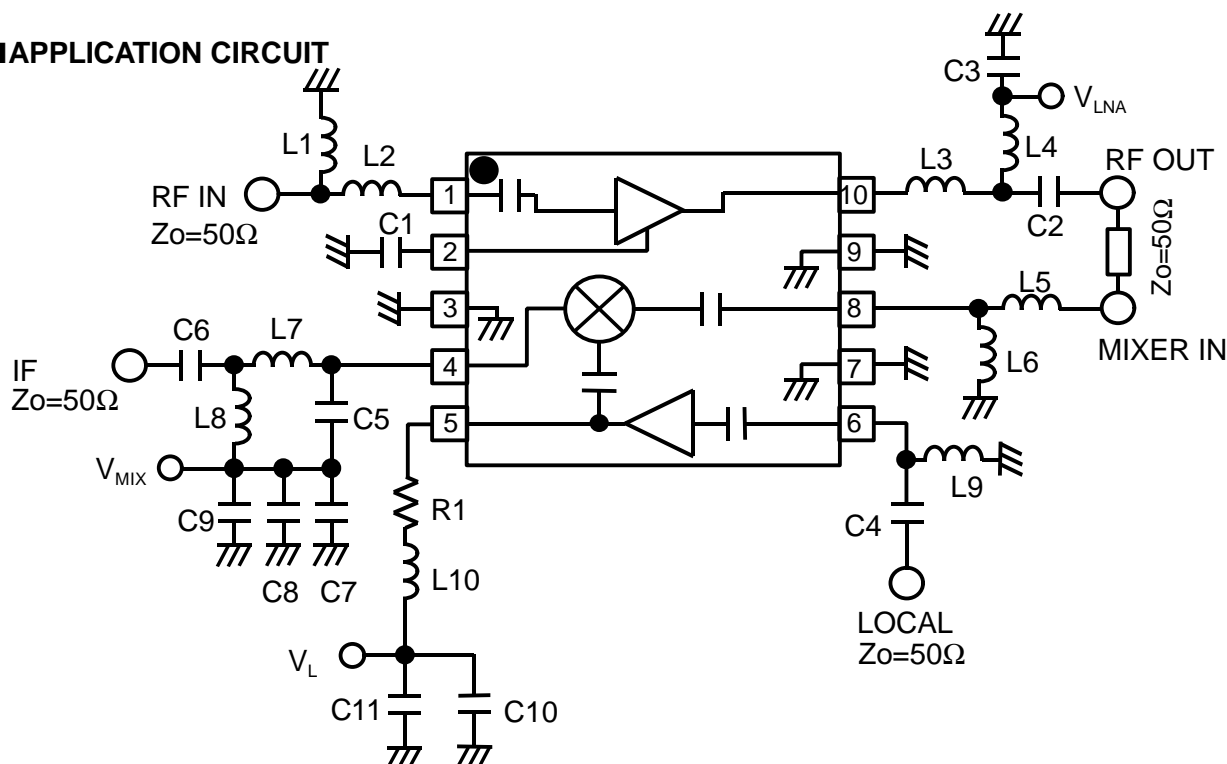

PARTS LIST

PART ID	800MHz band			COMMENT
	Lower LOCAL	Upper LOCAL	Upper LOCAL	
	$f_{LO}=690\text{MHz}$ $f_{IF}=130\text{MHz}$	$f_{LO}=950\text{MHz}$ $f_{IF}=130\text{MHz}$	$f_{LO}=1016.7\text{MHz}$ $f_{IF}=135.2\text{MHz}$	
L1	12nH	12nH	12nH	TAIYO-YUDEN (HK1608)
L2	15nH	15nH	15nH	TAIYO-YUDEN (HK1608)
L3	27nH	27nH	27nH	TAIYO-YUDEN (HK1005)
L4	12nH	12nH	12nH	TAIYO-YUDEN (HK1005)
L5	33nH	33nH	27nH	TAIYO-YUDEN (HK1005)
L6	22nH	22nH	22nH	TAIYO-YUDEN (HK1005)
L7	100nH	100nH	100nH	TAIYO-YUDEN (HK1608)
L8	56nH	56nH	47nH	TAIYO-YUDEN (HK1608)
L9	22nH	15nH	12nH	TAIYO-YUDEN (HK1005)
L10	33nH	33nH	22nH	TAIYO-YUDEN (HK1005)
C1	24pF	24pF	24pF	MURATA (GRM36)
C2	4pF	4pF	4pF	MURATA (GRM36)
C3	1000pF	1000pF	1000pF	MURATA (GRM36)
C4	1pF	1pF	1pF	MURATA (GRM36)
C5	9pF	9pF	9pF	MURATA (GRM36)
C6	1000pF	1000pF	1000pF	MURATA (GRM36)
C7	10pF	10pF	10pF	MURATA (GRM36)
C8	100pF	100pF	100pF	MURATA (GRM36)
C9	1000pF	1000pF	1000pF	MURATA (GRM36)
C10	100pF	100pF	100pF	MURATA (GRM36)
C11	1000pF	1000pF	1000pF	MURATA (GRM36)
R1	22Ω	22Ω	22Ω	TAMA Electronics (CRG16G)

* L1 and L2 are possible to use swaller chip, but NF will be worce.

NJG1704V

RECOMMENDED PCB DESIGN

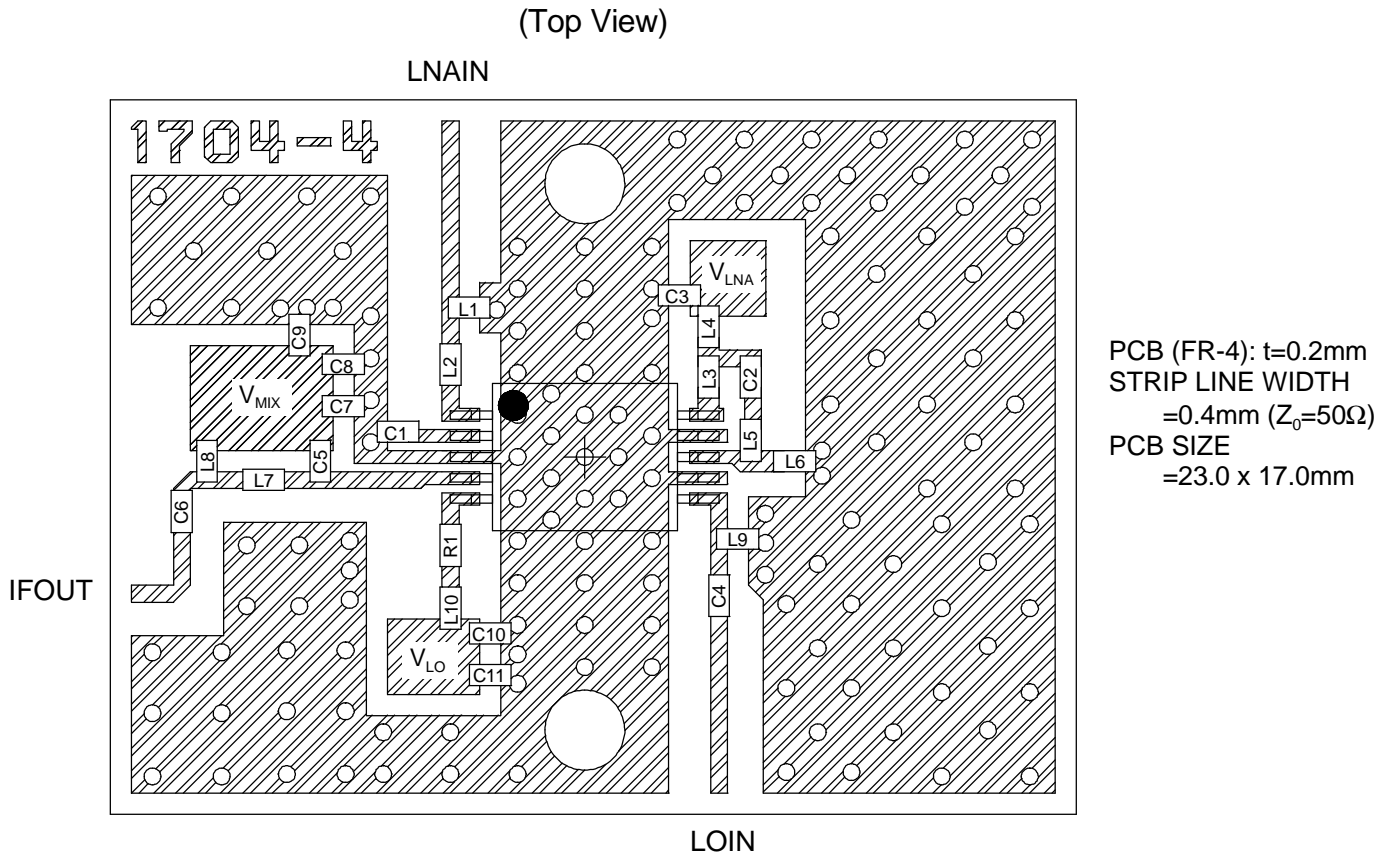

Caution on using devices.

- [1] Please place R1 close to the VLO terminal (5th pin), and L10 to the R1.
- [2] Please place C1 close to the LNACAP terminal (2nd pin)
- [3] Please place C3 close to L4.
- [4] Please place C5 close to C7, C8, and C9.
- [5] Please place L10 close to C10, C11.

MEASURING BLOCK DIAGRAM

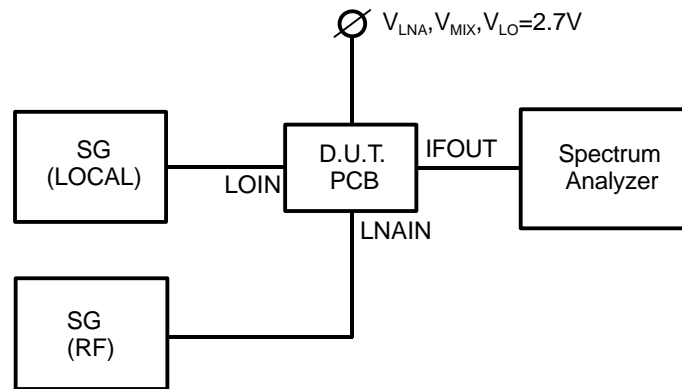

Conversion Gain Measurement Block Diagram

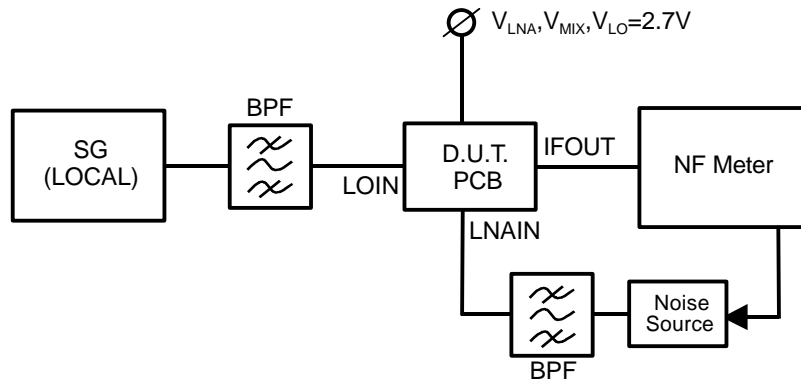

Noise Figure Measurement Block Diagram

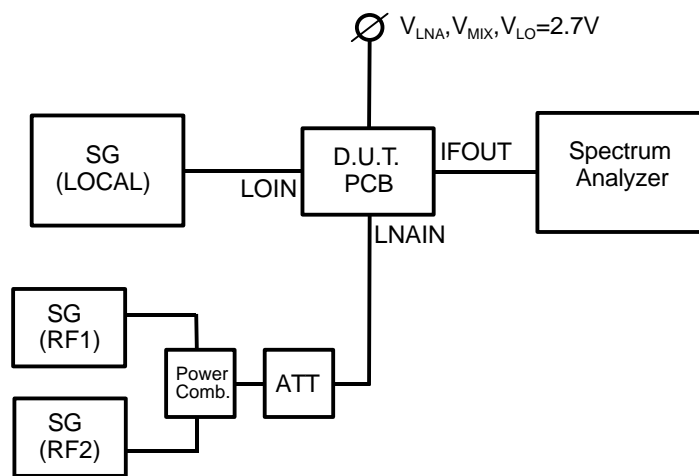

IF, IM3, IM5 Measurement Block Diagram

NJG1704V

PACKAGE OUTLINE (SSOP10)

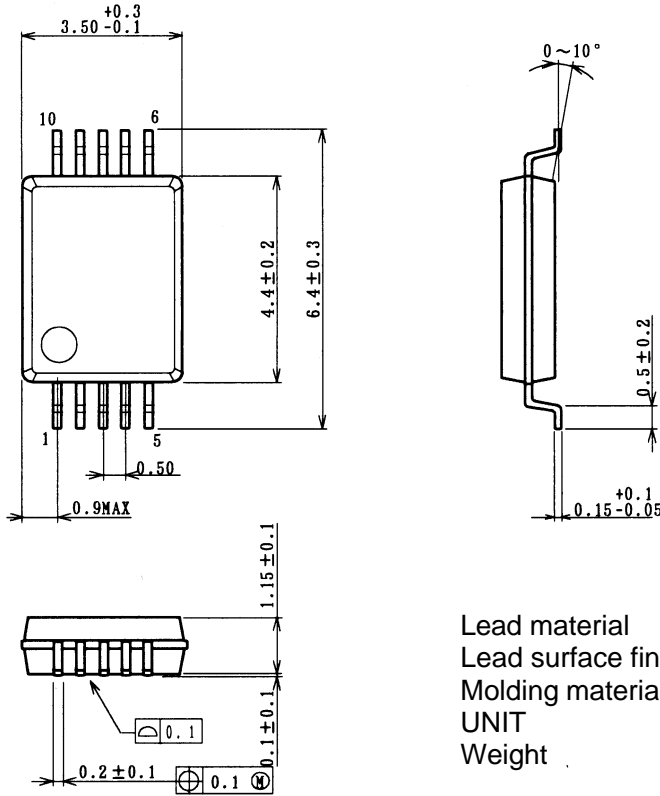

Lead material	: Copper
Lead surface finish	: Solder plating
Molding material	: Epoxy resin
UNIT	: mm
Weight	: 41mg

Cautions on using this product

This product contains Gallium-Arsenide (GaAs) which is a harmful material.

- Do NOT eat or put into mouth.
- Do NOT dispose in fire or break up this product.
- Do NOT chemically make gas or powder with this product.
- To waste this product, please obey the relating law of your country.

[CAUTION]

The specifications on this databook are only given for information, without any guarantee as regards either mistakes or omissions. The application circuits in this databook are described only to show representative usages of the product and not intended for the guarantee or permission of any right including the industrial rights.

This product may be damaged with electric static discharge (ESD) or spike voltage. Please handle with care to avoid these damages.