

For Facsimiles 3.3V to 5V Printing Voltage (A Series)

KA2008-AF10A

ROHM's A Series printheads for A4 paper size Facsimile applications utilize original integrated mounting technology, allowing for a wide range of logic voltages (3.13V to 5.25V).

●Applications

Facsimiles
Electric whiteboard
Measuring terminal printers

●Features

- 1) Providing easy design solution of power supply with the same bit number for each strobe at A4 size FAX application by employing the first in the industry 216 bits Driver IC.
- 2) Achieved Logic voltage of 3.13 to 5.25V and provides the wide range of power supply voltage. Wide selection of electrical components is able to choose.
- 3) Employment of ROHM's own technology clip connector makes it possible to supply the goods without heat sink and substrate it self. This allows wide range of designing since substrate could be directly attached to the mechanism.

●Dimensions (Unit : mm)

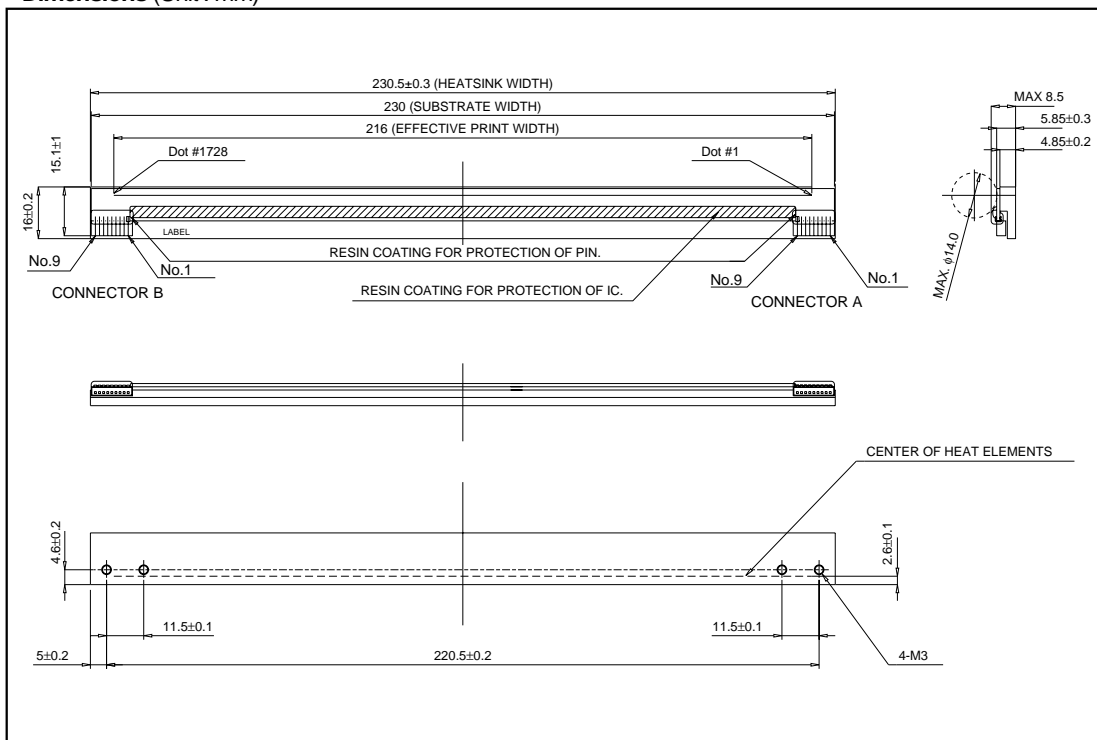

Printheads

●Equivalent circuit

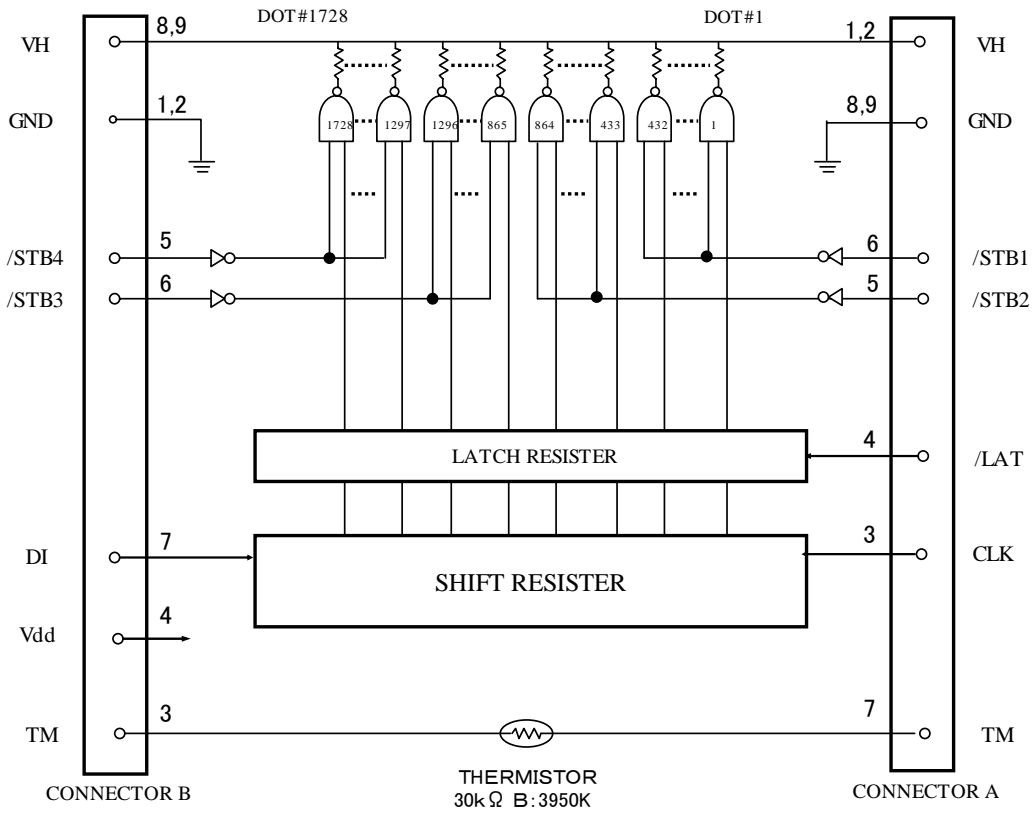

VH: 24 SUPPLY
 /STB: STROBE (HIGH ACTIVE)
 /LAT: LATCH
 CLK: CLOCK
 DI: DATA IN
 GND: GROUND
 TM: THERMISTOR

●Pin assignments

CONNECTOR B		CONNECTOR A	
No.	Circuit	No.	Circuit
1	GND	1	VH
2	GND	2	VH
3	TM	3	CLK
4	V _{DD}	4	$\overline{\text{LAT}}$
5	$\overline{\text{STB4}}$	5	$\overline{\text{STB2}}$
6	$\overline{\text{STB3}}$	6	$\overline{\text{STB1}}$
7	DI	7	TM
8	VH	8	GND
9	VH	9	GND

Printheads

●Timing chart

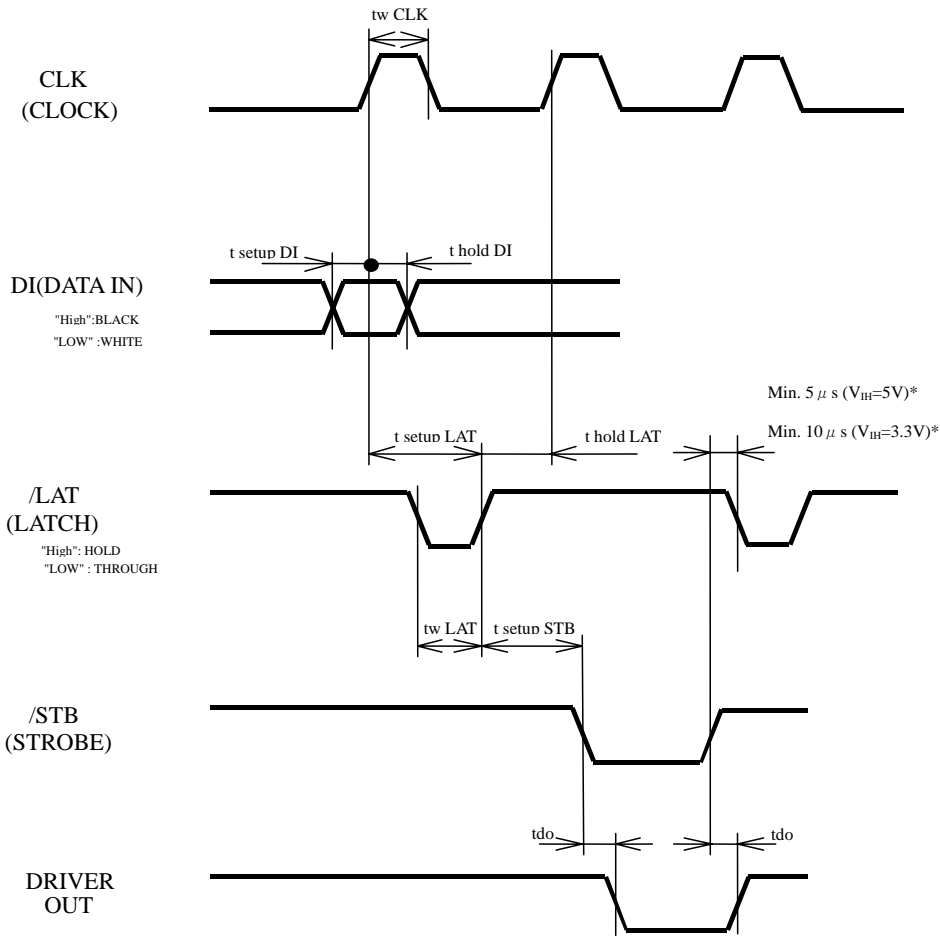

* If delay time for Driver Out can not be secured enough, there is a possibility that VH would fluctuate greatly. Please design the circuit so that VH does not exceed peak voltage (Vp).

●Characteristics

Parameter	Symbol	Typical	Unit
Effective printing width	—	216.0	mm
Dot pitch	—	0.125	mm
Total dot number	—	1728	dots
Average resistance value	Rave	3000	Ω
Applied voltage	V _H	24.0	V
Applied power	P _o	0.17	W/dot
Print cycle	SLT	10	ms
Pulse width	T _{ON}	1.95	ms
Maximum number of dots energized simultaneously	—	432	dots
Maximum clock frequency	—	4	MHz
Maximum roller diameter	—	$\phi 14.0$	mm
Running life / pulse life	—	30/3×10 ⁷	km/pulses
Operating temperature	—	5~45	°C

Printheads

●Electrical characteristic curves

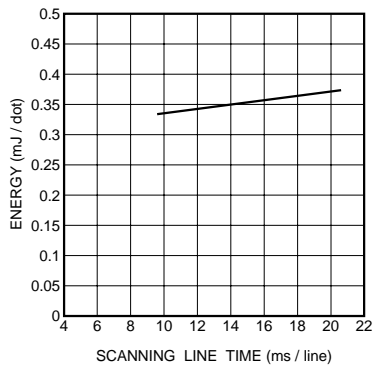

Fig.3 Adaptive speed chart

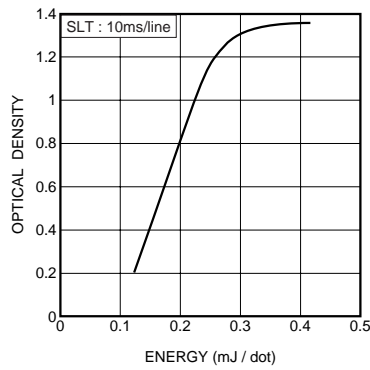

Fig.4 Representative density curve

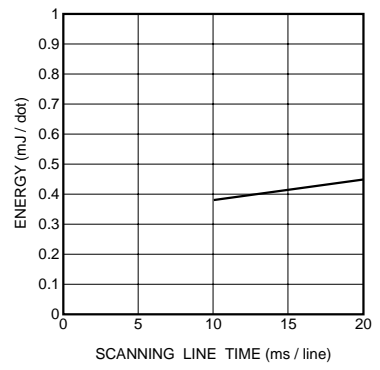

Fig.5 Maximum energy curve

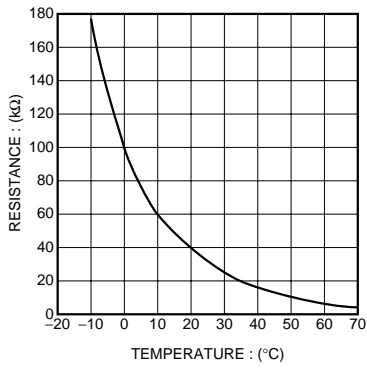

Fig.6 Thermistor curve

Notes

- No technical content pages of this document may be reproduced in any form or transmitted by any means without prior permission of ROHM CO.,LTD.
- The contents described herein are subject to change without notice. The specifications for the product described in this document are for reference only. Upon actual use, therefore, please request that specifications to be separately delivered.
- Application circuit diagrams and circuit constants contained herein are shown as examples of standard use and operation. Please pay careful attention to the peripheral conditions when designing circuits and deciding upon circuit constants in the set.
- Any data, including, but not limited to application circuit diagrams information, described herein are intended only as illustrations of such devices and not as the specifications for such devices. ROHM CO.,LTD. disclaims any warranty that any use of such devices shall be free from infringement of any third party's intellectual property rights or other proprietary rights, and further, assumes no liability of whatsoever nature in the event of any such infringement, or arising from or connected with or related to the use of such devices.
- Upon the sale of any such devices, other than for buyer's right to use such devices itself, resell or otherwise dispose of the same, no express or implied right or license to practice or commercially exploit any intellectual property rights or other proprietary rights owned or controlled by
- ROHM CO., LTD. is granted to any such buyer.
- Products listed in this document are no antiradiation design.

The products listed in this document are designed to be used with ordinary electronic equipment or devices (such as audio visual equipment, office-automation equipment, communications devices, electrical appliances and electronic toys).

Should you intend to use these products with equipment or devices which require an extremely high level of reliability and the malfunction of which would directly endanger human life (such as medical instruments, transportation equipment, aerospace machinery, nuclear-reactor controllers, fuel controllers and other safety devices), please be sure to consult with our sales representative in advance.

It is our top priority to supply products with the utmost quality and reliability. However, there is always a chance of failure due to unexpected factors. Therefore, please take into account the derating characteristics and allow for sufficient safety features, such as extra margin, anti-flammability, and fail-safe measures when designing in order to prevent possible accidents that may result in bodily harm or fire caused by component failure. ROHM cannot be held responsible for any damages arising from the use of the products under conditions out of the range of the specifications or due to non-compliance with the NOTES specified in this catalog.

Thank you for your accessing to ROHM product informations.

More detail product informations and catalogs are available, please contact your nearest sales office.

ROHM Customer Support System

THE AMERICAS / EUROPE / ASIA / JAPAN

www.rohm.com

Contact us : webmaster@rohm.co.jp