



MJE13009

NPN SILICON TRANSISTOR

SWITCHMODE SERIES NPN SILICON POWER TRANSISTORS

■ DESCRIPTION

The **MJE13009** is designed for high-voltage, high-speed power switching inductive circuits where fall time is critical. They are particularly suited for 115 and 220V switch mode applications such as Switching Regulators, Inverters, Motor Controls, Solenoid/Relay drivers and Deflection circuits.

■ FEATURES

- * V_{CE0} 400V and 300 V
- * Reverse Bias SOA with Inductive Loads @ $T_C = 100^\circ\text{C}$
- * Inductive Switching Matrix 3 ~ 12 Amp, 25 and 100°C
 t_c @ 8 A, 100°C is 120 ns (Typ).
- * 700 V Blocking Capability
- * SOA and Switching Applications Information.

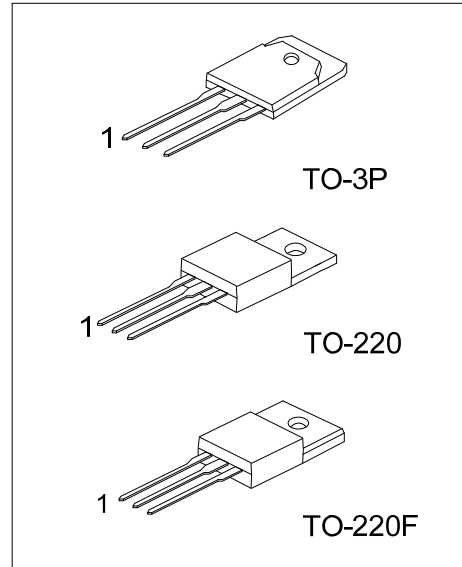

■ ORDERING INFORMATION

Ordering Number		Package	Pin Assignment			Packing
Lead Free	Halogen Free		1	2	3	
MJE13009L-TA3-T	MJE13009G-TA3-T	TO-220	B	C	E	Tube
MJE13009L-TF3-T	MJE13009G-TF3-T	TO-220F	B	C	E	Tube
MJE13009L-T3P-T	MJE13009G-T3P-T	TO-3P	B	C	E	Tube

<p>MJE13009L-TA3-T</p> <p>(1)Packing Type (2)Package Type (3)Lead Free</p>	<p>(1) T: Tube (2) TA3: TO-220, TF3: TO-220F, T3P: TO-3P (3) G: Halogen Free, L: Lead Free</p>
--	--

■ ABSOLUTE MAXIMUM RATINGS (T_A = 25°C)

PARAMETER		SYMBOL	RATINGS	UNIT
Collector-Emitter Voltage		V _{CEO}	400	V
Collector-Emitter Voltage (V _{BE} =-1.5V)		V _{CEV}	700	V
Emitter Base Voltage		V _{EBO}	9	V
Collector Current	Continuous	I _C	12	A
	Peak (Note 3)	I _{CM}	24	
Base Current	Continuous	I _B	6	A
	Peak (Note 3)	I _{BM}	12	
Emitter Current	Continuous	I _E	18	A
	Peak (Note 3)	I _{EM}	36	
Power Dissipation	TO-220	P _D	2	W
	TO-220F		0.7	
	TO-3P		80	
Derate above 25°C	TO-220		16	mW/°C
	TO-220F		5.6	
	TO-3P		640	
Junction Temperature		T _J	+150	°C
Storage Temperature		T _{STG}	-40 ~ +150	°C

Note: 1. Pulse Test: Pulse Width = 5ms, Duty Cycle ≤ 10%

2. Absolute maximum ratings are those values beyond which the device could be permanently damaged.

Absolute maximum ratings are stress ratings only and functional device operation is not implied.

3. Pulse Test: Pulse Width = 300μs, Duty Cycle = 2%

■ THERMAL DATA

PARAMETER		SYMBOL	RATINGS	UNIT
Junction to Ambient	TO-220	θ _{JA}	54	°C/W
	TO-220F		62.5	
	TO-3P		21	
Junction to Case	TO-220	θ _{JC}	4	°C/W
	TO-220F		3.13	
	TO-3P		1.55	

■ ELECTRICAL CHARACTERISTICS (T_C = 25°C, unless otherwise specified.)

PARAMETER	SYMBOL	TEST CONDITIONS	MIN	TYP	MAX	UNIT
OFF CHARACTERISTICS (Note)						
Collector- Emitter Sustaining Voltage	V _{CEO}	I _C = 10mA, I _B = 0	400			V
Collector Cutoff Current V _{CB0} =Rated Value	I _{CEV}	V _{BE(OFF)} = 1.5V _{DC} V _{BE(OFF)} = 1.5V _{DC} , T _C = 100°C			1 5	mA
Emitter Cutoff Current	I _{EBO}	V _{EB} = 9V _{DC} , I _C = 0			1	mA
ON CHARACTERISTICS (Note)						
DC Current Gain	h _{FE1}	I _C = 5A, V _{CE} = 5V			40	
	h _{FE2}	I _C = 8A, V _{CE} = 5V			30	
Current-Emitter Saturation Voltage	V _{CE(SAT)}	I _C = 5A, I _B = 1A			1	V
		I _C = 8A, I _B = 1.6A			1.5	V
		I _C = 12A, I _B = 3A			3	V
		I _C = 8A, I _B = 1.6A, T _C = 100°C			2	V
Base-Emitter Saturation Voltage	V _{BE(SAT)}	I _C = 5A, I _B = 1A			1.2	V
		I _C = 8A, I _B = 1.6A			1.6	V
		I _C = 8A, I _B = 1.6A, T _C = 100°C			1.5	V

■ ELECTRICAL CHARACTERISTICS(Cont.)

PARAMETER	SYMBOL	TEST CONDITIONS	MIN	TYP	MAX	UNIT
DYNAMIC CHARACTERISTICS						
Transition frequency	f_T	$I_C = 500\text{mA}$, $V_{CE} = 10\text{V}$, $f = 1\text{MHz}$	4			MHz
Output Capacitance	C_{OB}	$V_{CB} = 10\text{V}$, $I_E = 0$, $f = 0.1\text{MHz}$		180		pF
SWITCHING CHARACTERISTICS (Resistive Load, Table 1)						
Delay Time	t_{DLY}	$V_{CC} = 125\text{Vdc}$, $I_C = 8\text{A}$ $I_{B1} = I_{B2} = 1.6\text{A}$, $t_P = 25\mu\text{s}$ Duty Cycle $\leq 1\%$		0.06	0.1	μs
Rise Time	t_R			0.45	1	μs
Storage Time	t_S			1.3	3	μs
Fall Time	t_F			0.2	0.7	μs
Inductive Load, Clamped (Table 1, Fig. 13)						
Voltage Storage Time	t_S	$I_C = 8\text{A}$, $V_{CLAMP} = 300\text{V}$, $I_{B1} = 1.6\text{A}$		0.92	2.3	μs
Crossover Time	t_C	$V_{BE(OFF)} = 5\text{V}$, $T_C = 100^\circ\text{C}$		0.12	0.7	μs

Note: Pulse Test: Pulse Width = $300\mu\text{s}$, Duty Cycle = 2%

■ TABLE 1. TEST CONDITIONS FOR DYNAMIC PERFORMANCE

	REVERSE BIAS SAFE OPERATING AREA AND INDUCTIVE SWITCHING	RESISTIVE SWITCHING
TEST CIRCUITS	<p>DUTY CYCLE \leq 10% $t_R, t_F \leq$ 10 ns</p> <p>Note: P_w and V_{CC} Adjusted for Desired I_C R_B Adjusted for Desired I_{B1}</p>	
CIRCUIT VALUES	<p>Coil Data: Ferroxcube Core #6656 Full Bobbin (~16 Turns) #16</p> <p>GAP for 200µH/20A $L_{COIL} = 200\mu H$</p> <p>$V_{CC} = 20V$ $V_{CLAMP} = 300V_{DC}$</p>	<p>$V_{CC} = 125V$ $R_C = 15\Omega$ D1 = 1N5820 or Equiv. $R_B = \Omega$</p>
TEST WAVEFORMS	<p>OUTPUT WAVEFORMS</p> <p>t_1 ADJUSTED TO OBTAIN I_C</p> $t_1 \approx \frac{L_{COIL}(I_{CM})}{V_{CC}}$ $t_2 \approx \frac{L_{COIL}(I_{CM})}{V_{CLAMP}}$ <p>Test Equipment Scope-Tektronics 475 or Equivalent</p>	<p>$t_R, t_F < 10$ ns Duty Cycle = 1.0% R_B and R_C adjusted for desired I_B and I_C</p>

■ TABLE 2. APPLICATIONS EXAMPLES OF SWITCHING CIRCUITS

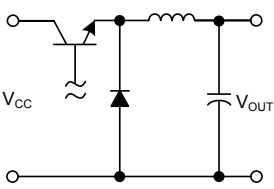
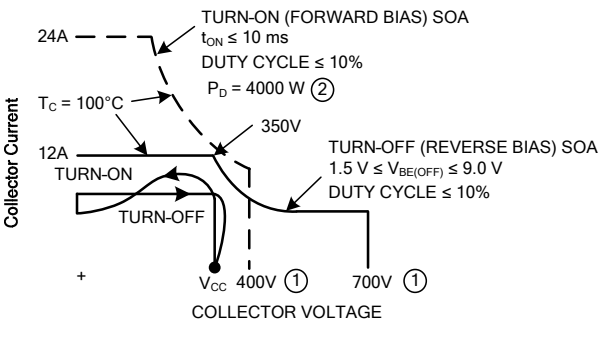
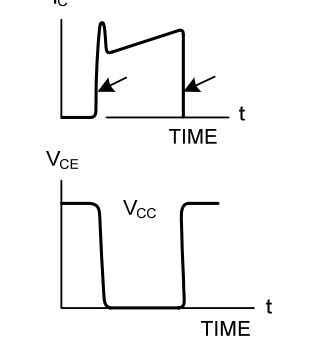
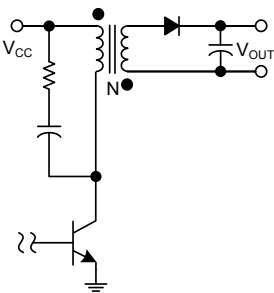
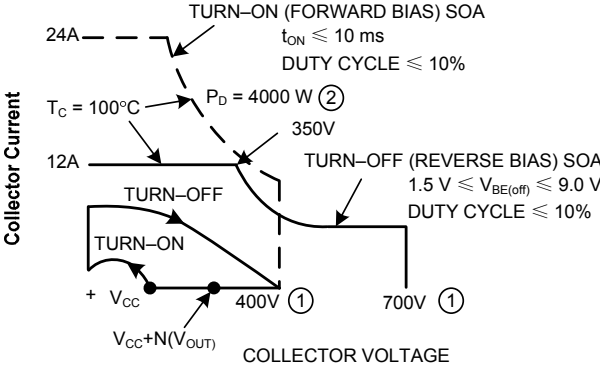
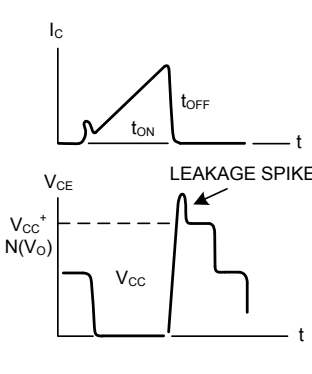
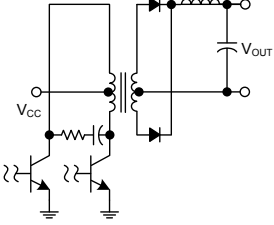
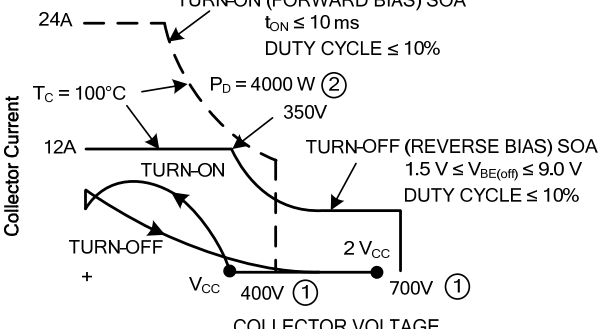
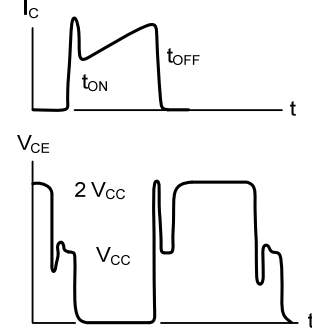
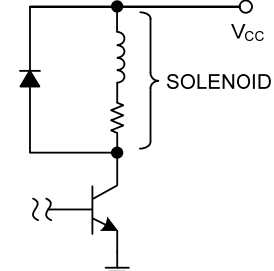
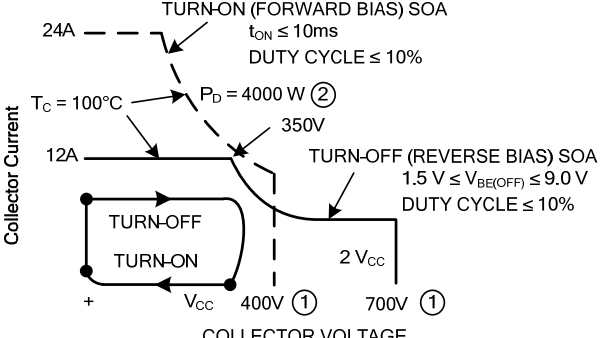
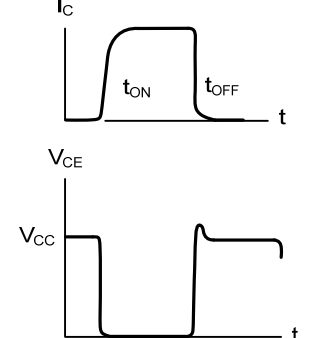
CIRCUIT	LOAD LINE DIAGRAMS	TIME DIAGRAMS
<p>SERIES SWITCHING REGULATOR</p> 		
<p>RINGING CHOKE INVERTER</p> 		
<p>PUSH-PULL INVERTER/CONVERTER</p> 		
<p>SOLENOID DRIVER</p> 		

■ TABLE 3. TYPICAL INDUCTIVE SWITCHING PERFORMANCE

I _C (A)	T _C (°C)	t _{SV} (ns)	t _{RV} (ns)	t _{FI} (ns)	t _{TI} (ns)	t _C (ns)
3	25	770	100	150	200	240
	100	1000	230	160	200	320
5	25	630	72	26	10	100
	100	820	100	55	30	180
8	25	720	55	27	2	77
	100	920	70	50	8	120
12	25	640	20	17	2	41
	100	800	32	24	4	54

■ SWITCHING TIME NOTES

In resistive switching circuits, rise, fall, and storage times have been defined and apply to both current and voltage waveforms since they are in phase. However, for inductive loads which are common to SWITCHMODE power supplies and hammer drivers, current and voltage waveforms are not in phase. Therefore, separate measurements must be made on each waveform to determine the total switching time. For this reason, the following new terms have been defined.

t_{SV} = Voltage Storage Time, 90% I_{B1} to 10% V_{CEM}

t_{RV} = Voltage Rise Time, 10–90% V_{CEM}

t_{FI} = Current Fall Time, 90–10% I_{CM}

t_{TI} = Current Tail, 10–2% I_{CM}

t_C = Crossover Time, 10% V_{CEM} to 10% I_{CM}

An enlarged portion of the turn-off waveforms is shown in Fig. 13 to aid in the visual identity of these terms.

For the designer, there is minimal switching loss during storage time and the predominant switching power losses occur during the crossover interval and can be obtained using the standard equation from AN-222:

$$P_{SWT} = 1/2 V_{CC} I_C (t_C) f$$

Typical inductive switching waveforms are shown in Fig. 14. In general, t_{RV} + t_{FI} ≈ t_C. However, at lower test currents this relationship may not be valid.

As is common with most switching transistors, resistive switching is specified at 25°C and has become a benchmark for designers. However, for designers of high frequency converter circuits, the user oriented specifications which make this a “SWITCHMODE” transistor are the inductive switching speeds (t_C and t_{SV}) which are guaranteed at 100°C.

TYPICAL CHARACTERISTICS

Fig. 1 Forward Bias Safe Operating Area

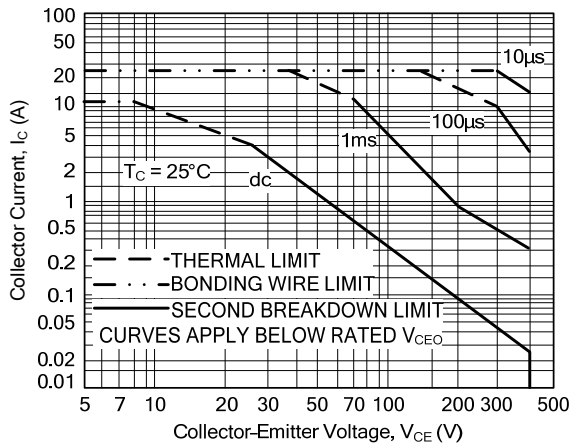

Fig. 2 Reverse Bias Switching Safe Operating Area

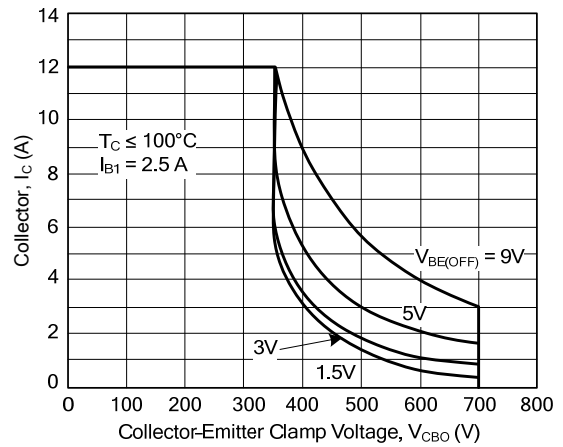
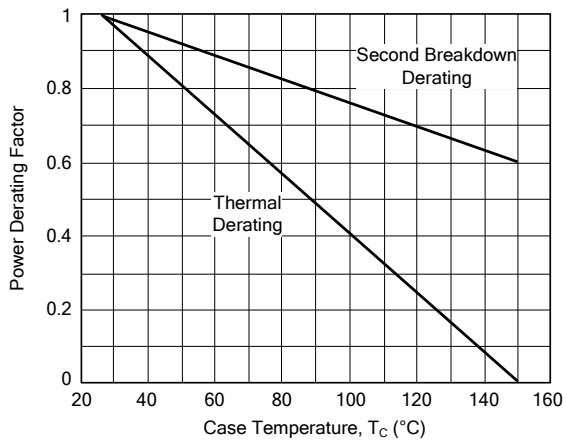

Fig. 3 Forward Bias Power Derating



There are two limitations on the power handling ability of a transistor: average junction temperature and second breakdown. Safe operating area curves indicate $I_C - V_{CE}$ limits of the transistor that must be observed for reliable operation; i.e., the transistor must not be subjected to greater dissipation than the curves indicate.

The data of Fig. 1 is based on $T_C = 25^\circ\text{C}$; $T_{J(PK)}$ is variable depending on power level. Second breakdown pulse limits are valid for duty cycles to 10% but must be derated when $T_C \geq 25^\circ\text{C}$. Second breakdown limitations do not derate the same as thermal limitations. Allowable current at the voltages shown on Fig. 1 may be found at any case temperature by using the appropriate curve on Fig. 3.

$T_{J(PK)}$ may be calculated from the data in Fig. 4. At high case temperatures, thermal limitations will reduce the power that can be handled to values less than the limitations imposed by second breakdown. Use of reverse biased safe operating area data (Fig. 2) is discussed in the applications information section.

Fig. 4 Typical Thermal Response [$Z_{\theta JC}(t)$]

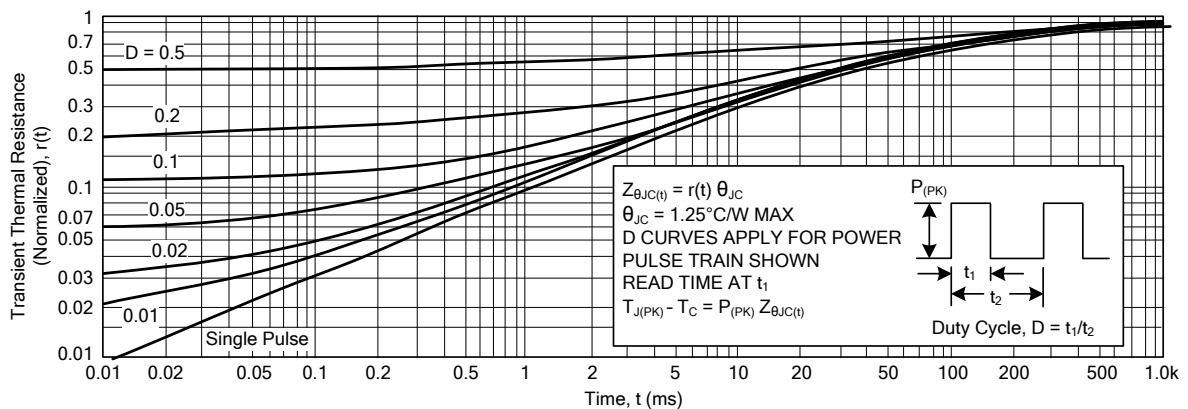

■ TYPICAL CHARACTERISTICS (Cont.)

Fig. 5 DC Current Gain

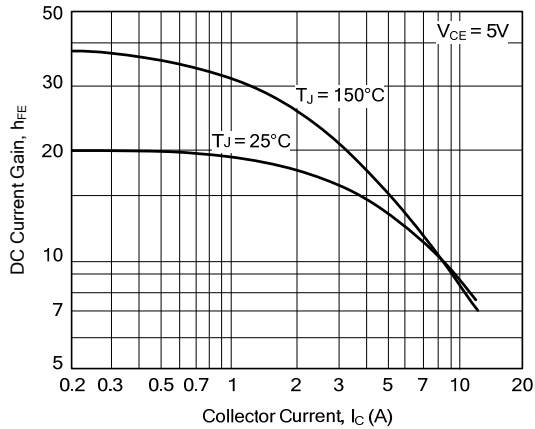

Fig. 6 Collector Saturation Region

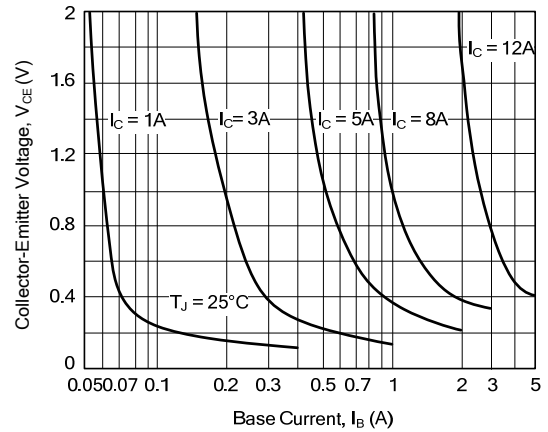

Fig. 7 Base-Emitter Saturation Voltage

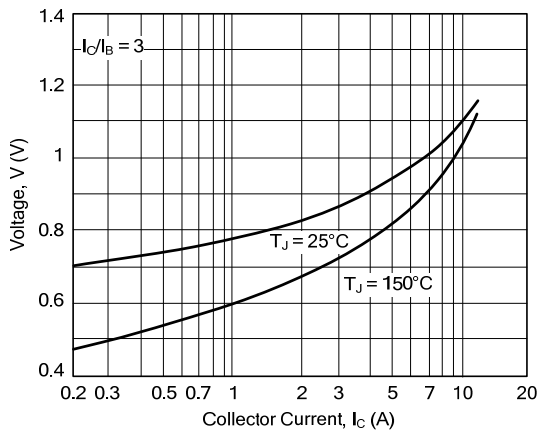

Fig. 8 Collector-Emitter Saturation Voltage

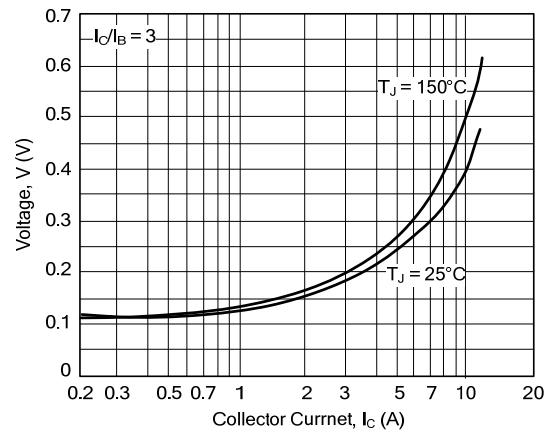

Fig. 9 Collector Cutoff Region

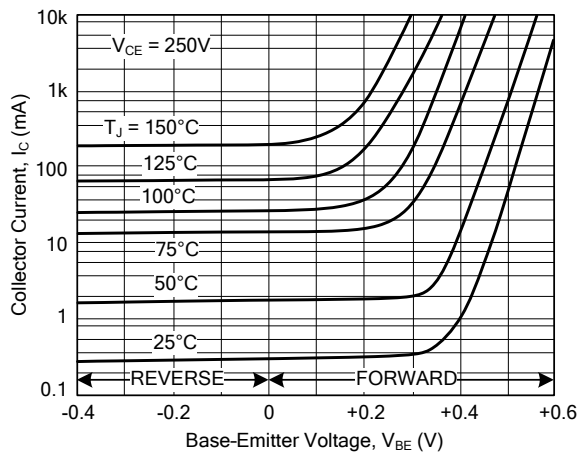
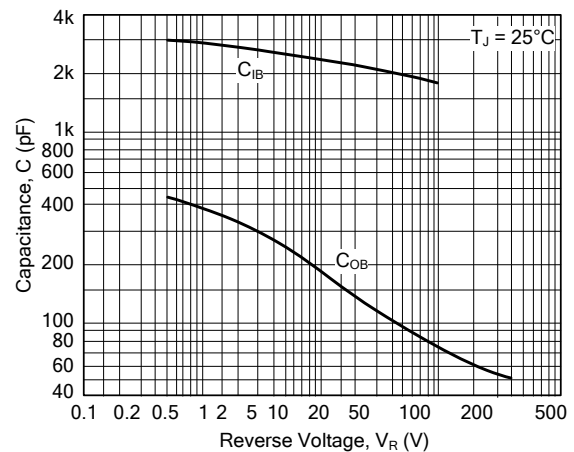

Fig. 10 Capacitance



RESISTIVE SWITCHING PERFORMANCE

Fig. 11. Turn-On Time

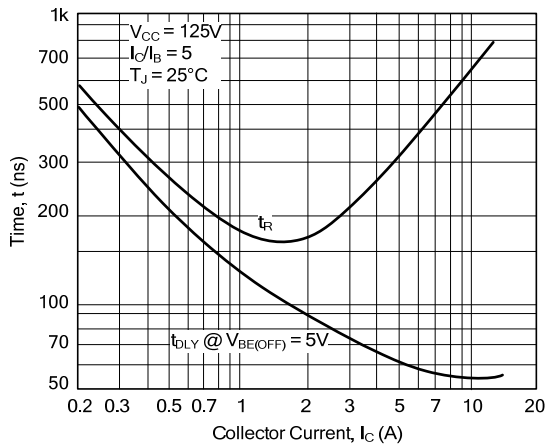

Fig. 12 Turn-Off Time

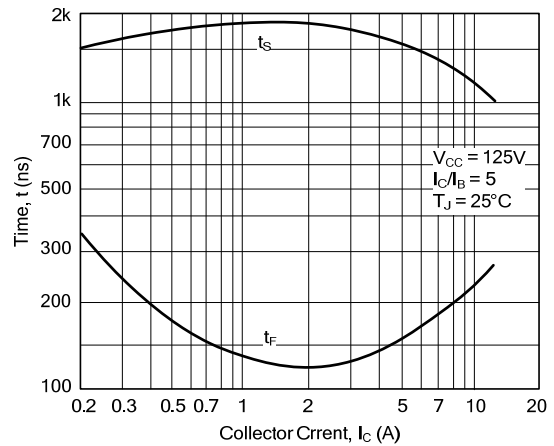
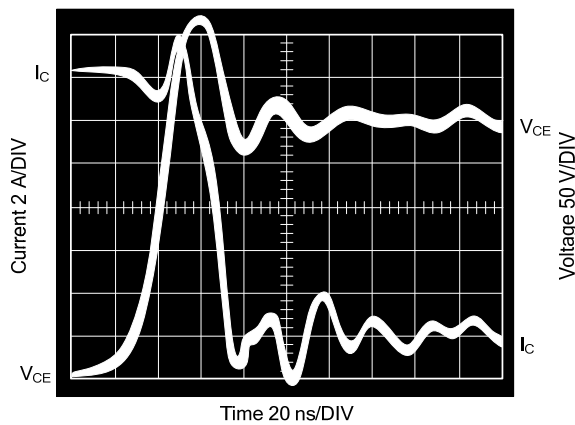

Fig. 13 Typical Inductive Switching Waveforms (at 300V and 12A with $I_{B1} = 2.4A$ and $V_{BE(OFF)} = 5V$)



UTC assumes no responsibility for equipment failures that result from using products at values that exceed, even momentarily, rated values (such as maximum ratings, operating condition ranges, or other parameters) listed in products specifications of any and all UTC products described or contained herein. UTC products are not designed for use in life support appliances, devices or systems where malfunction of these products can be reasonably expected to result in personal injury. Reproduction in whole or in part is prohibited without the prior written consent of the copyright owner. The information presented in this document does not form part of any quotation or contract, is believed to be accurate and reliable and may be changed without notice.