

CZRT23C2V7-HF Thru. CZRT23C39-HF

Zener Voltage: 2.7V to 39V

Power Dissipation: 300mW

RoHS Device

Halogen Free

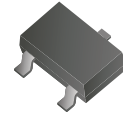

Features

- Dual Zeners in common anode configuration.
- 300mW power dissipation rating.
- Ideally suited for automatic insertion.
- ΔV_Z for both diodes in one case is $\leq 5\%$.
- Common cathode style available see Dz Series.

Mechanical Data

- Case: SOT-23 mold plastic

Circuit Diagram

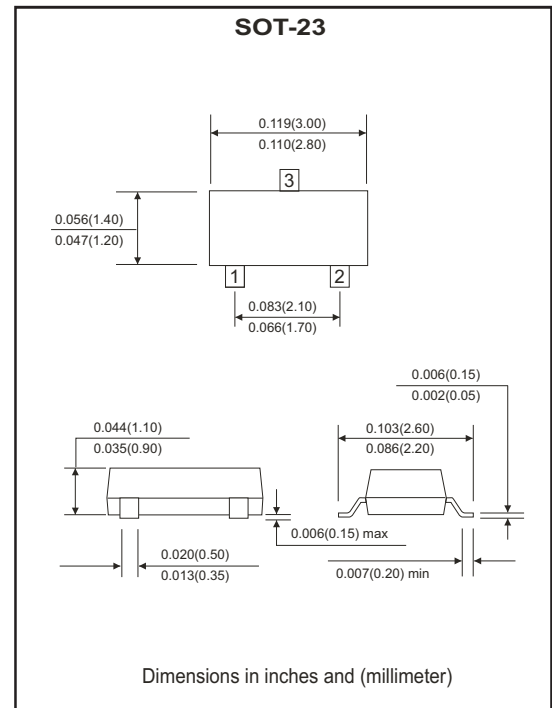
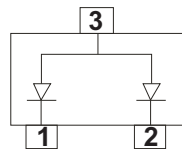

Maximum Ratings (at Ta=25°C unless otherwise noted)

Parameter	Symbol	Value	Unit
Power dissipation	P _D	300	mW
Thermal Resistance, junction to ambient	R _{θJA}	417	°C/W
Operating junction temperature	T _J	-65 ~ +150	°C
Storage temperature	T _{STG}	-65 ~ +150	°C

ELECTRICAL CHARACTERISTIC (CZRT23C2V7-HF Thru. CZRT23C39-HF)

Type	Marking Code	Zener voltage range (1)	Maximum Zener impedance (2)		Typical temperature coefficient	Min. reverse voltage (1)
		@I _{ZT} =5.0mA	@I _{ZT} =5.0mA	@I _{ZK} =1.0mA		@I _R =0.1μA
		V _Z (V)	Z _{ZT} (Ω)	Z _{ZK} (Ω)	T _C (%/°C)	V _R (V)
CZRT23C2V7-HF	ΚD1	2.5~2.9	83	500	-0.065	---
CZRT23C3V0-HF	ΚD2	2.8~3.2	95	500	-0.060	---
CZRT23C3V3-HF	ΚD3	3.1~3.5	95	500	-0.055	---
CZRT23C3V6-HF	ΚD4	3.4~3.8	95	500	-0.055	---
CZRT23C3V9-HF	ΚD5	3.7~4.1	95	500	-0.050	---
CZRT23C4V3-HF	ΚD6	4.0~4.6	95	500	-0.035	---
CZRT23C4V7-HF	ΚD7	4.4~5.0	78	500	-0.015	---
CZRT23C5V1-HF	ΚD8	4.8~5.4	60	480	0.005	0.8
CZRT23C5V6-HF	ΚD9	5.2~6.0	40	400	0.020	1.0
CZRT23C6V2-HF	ΚDA	5.8~6.6	10	200	0.030	2.0
CZRT23C6V8-HF	ΚDB	6.4~7.2	8	150	0.045	3.0
CZRT23C7V5-HF	ΚDC	7.0~7.9	7	50	0.050	5.0
CZRT23C8V2-HF	ΚDD	7.7~8.7	7	50	0.055	6.0
CZRT23C9V1-HF	ΚDE	8.5~9.6	10	50	0.065	7.0
CZRT23C10-HF	ΚDF	9.4~10.6	15	70	0.065	7.5
CZRT23C11-HF	ΚDG	10.4~11.6	20	70	0.070	8.5
CZRT23C12-HF	ΚDH	11.4~12.7	20	90	0.080	9.0
CZRT23C13-HF	ΚDI	12.4~14.1	25	110	0.080	10.0
CZRT23C15-HF	ΚDJ	13.8~15.6	30	110	0.090	11.0
CZRT23C16-HF	ΚDK	15.8~17.1	40	170	0.090	12.0
CZRT23C18-HF	ΚDL	16.8~19.1	50	170	0.090	14.0
CZRT23C20-HF	ΚDM	18.8~21.2	50	220	0.090	15.0
CZRT23C22-HF	ΚDN	20.8~23.3	55	220	0.090	17.0
CZRT23C24-HF	ΚDO	22.8~25.6	80	220	0.090	18.0
CZRT23C27-HF	ΚDP	25.1~28.9	80	250	0.090	20.0
CZRT23C30-HF	ΚDQ	28~32	80	250	0.090	22.5
CZRT23C33-HF	ΚDR	31~35	80	250	0.090	25.0
CZRT23C36-HF	ΚDS	34~38	90	250	0.090	27.0
CZRT23C39-HF	ΚDT	37~41	90	300	0.110	29.0

NOTES:

(1) Short duration test pulse used to minimize self-heating effect.

(2) f=1KHz

RATINGS and CHARACTERISTIC CURVE (CZRT23C2V7-HF Thru. CZRT23C39-HF)

Fig.1- Power Derating Curve

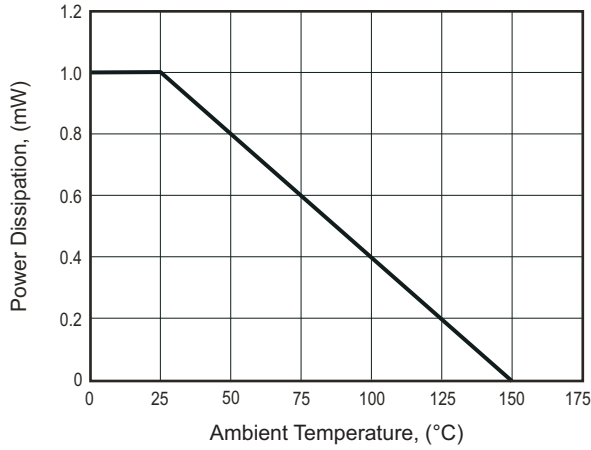

Fig.2- Zener Breakdown Characteristics

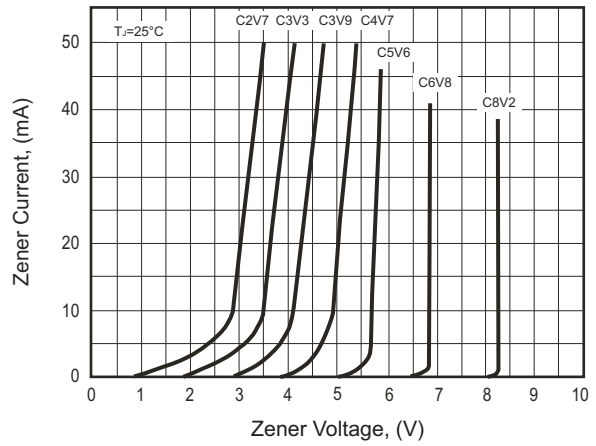
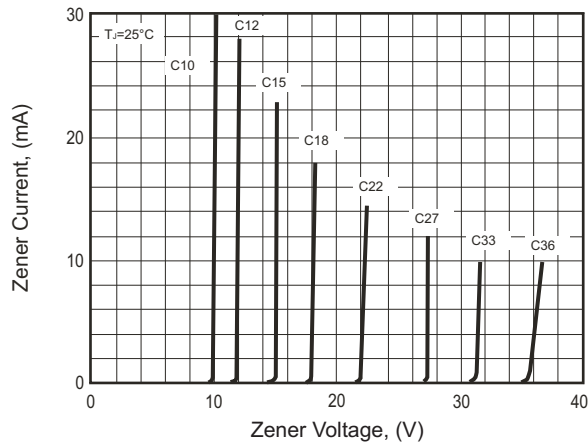
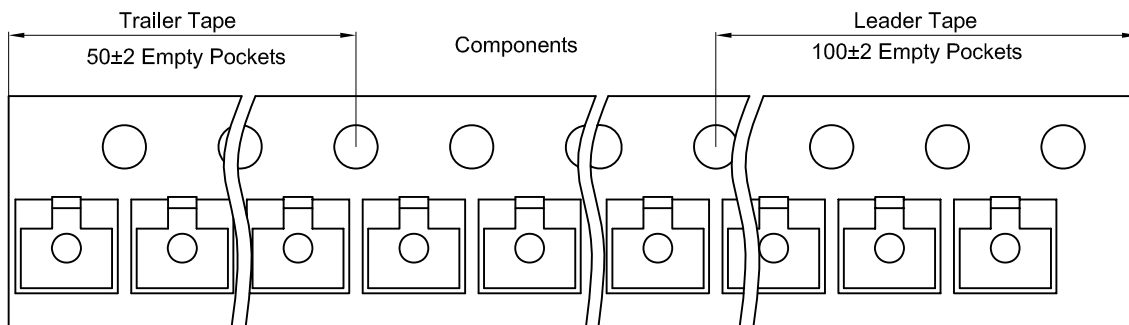
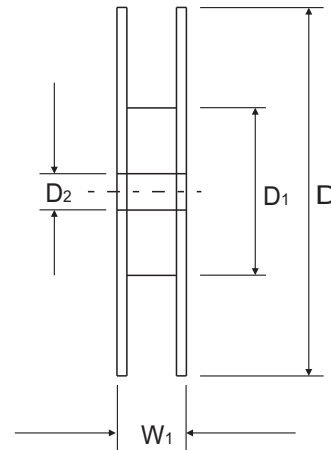
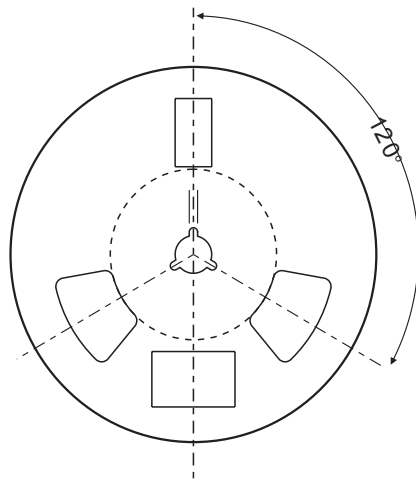
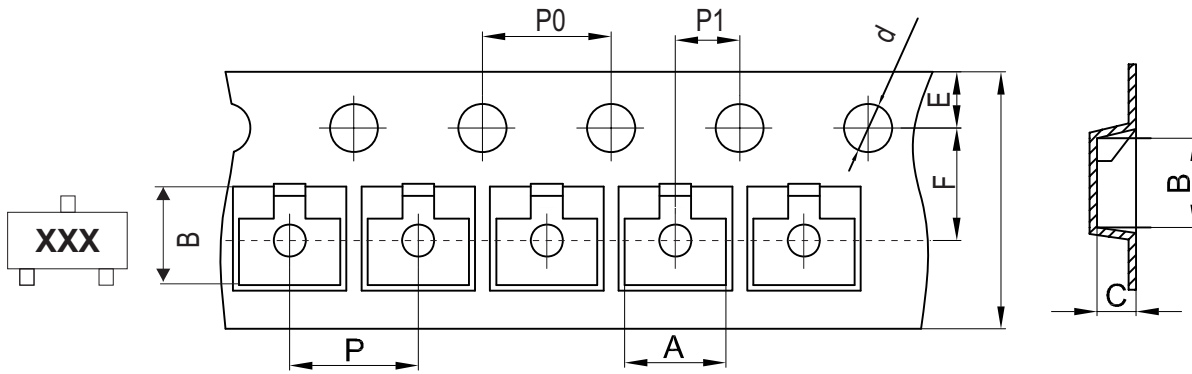

Fig.3- Zener Breakdown Characteristics



Reel Taping Specification



SOT-23	SYMBOL	A	B	C	d	D	D1	D2
	(mm)	3.15 ± 0.10	2.77 ± 0.10	1.22 ± 0.10	1.50 ± 0.10	178 ± 2.00	54.40 ± 1.00	13.00 ± 1.00
	(inch)	0.124 ± 0.004	0.109 ± 0.004	0.048 ± 0.004	0.059 ± 0.004	7.008 ± 0.079	2.142 ± 0.039	0.512 ± 0.039

SOT-23	SYMBOL	E	F	P	P0	P1	W	W1
	(mm)	1.75 ± 0.10	3.50 ± 0.10	4.00 ± 0.10	4.00 ± 0.10	2.00 ± 0.10	8.00 + 0.30 / - 0.10	12.30 ± 1.0
	(inch)	0.069 ± 0.004	0.138 ± 0.004	0.157 ± 0.004	0.157 ± 0.004	0.079 ± 0.004	0.315 + 0.012 / - 0.004	0.484 ± 0.039

Company reserves the right to improve product design , functions and reliability without notice.

Marking Code

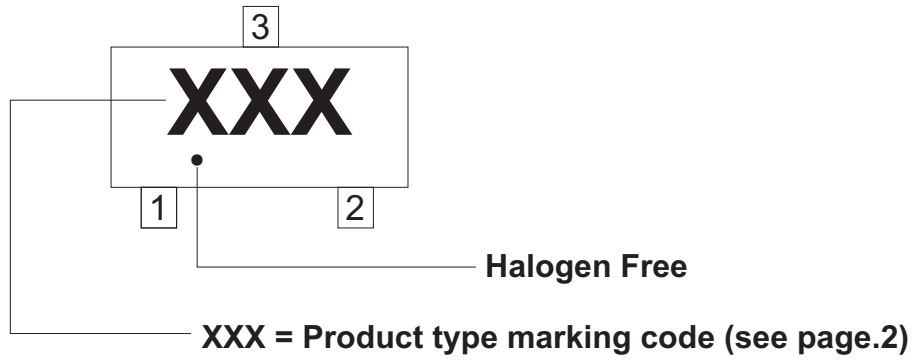

Suggested PAD Layout

SIZE	SOT-23	
	(mm)	(inch)
A	0.80	0.031
B	1.90	0.075
C	2.02	0.080
D	2.82	0.111
E	0.80	0.031

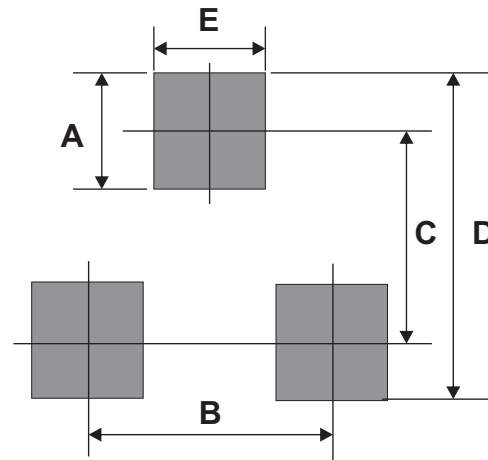

Standard Packaging

Case Type	REEL PACK	
	REEL (pcs)	Reel Size (inch)
SOT-23	3,000	7