

## HEXFET® Power MOSFET for DC-DC Converters

- N-Channel Application-Specific MOSFETs
- Ideal for CPU Core DC-DC Converters
- Low Conduction Losses
- Low Switching Losses

### Description

This new device employs advanced HEXFET Power MOSFET technology to achieve an unprecedented balance of on-resistance and gate charge. The reduced conduction and switching losses make it ideal for high efficiency DC-DC converters that power the latest generation of microprocessors.

The IRF7822 has been optimized for all parameters that are critical in synchronous buck converters including  $R_{DS(on)}$ , gate charge and  $Cdv/dt$ -induced turn-on immunity. The IRF7822 offers particularly low  $R_{DS(on)}$  and high  $Cdv/dt$  immunity for synchronous FET applications.

The package is designed for vapor phase, infra-red, convection, or wave soldering techniques. Power dissipation of greater than 3W is possible in a typical PCB mount application.

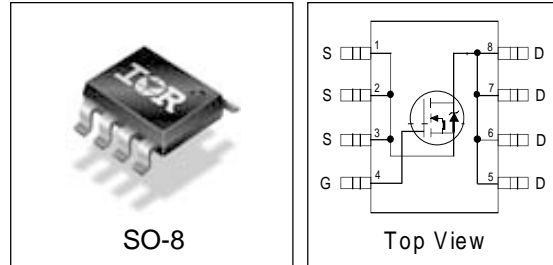

### DEVICE CHARACTERISTICS<sup>⑤</sup>

IRF7822	
$R_{DS(on)}$	5.0mΩ
$Q_G$	44nC
$Q_{sw}$	12nC
$Q_{oss}$	27nC

### Absolute Maximum Ratings

Parameter	Symbol	IRF7822	Units
Drain-Source Voltage	$V_{DS}$	30	V
Gate-Source Voltage	$V_{GS}$	±12	
Continuous Drain or Source Current ( $V_{GS} \geq 4.5V$ )	$T_A = 25^\circ C$	18	A
	$T_A = 70^\circ C$	13	
Pulsed Drain Current <sup>①</sup>	$I_{DM}$	150	
Power Dissipation	$T_A = 25^\circ C$	3.1	W
	$T_A = 70^\circ C$	3.0	
Junction & Storage Temperature Range	$T_J, T_{STG}$	-55 to 150	°C
Continuous Source Current (Body Diode)	$I_S$	3.8	A
Pulsed Source Current <sup>①</sup>	$I_{SM}$	150	

### Thermal Resistance

Parameter		Max.	Units
Maximum Junction-to-Ambient <sup>③</sup>	$R_{\theta JA}$	40	°C/W
Maximum Junction-to-Lead	$R_{\theta JL}$	20	°C/W

# IRF7822

International  
**IR** Rectifier

## Electrical Characteristics

Parameter		Min	Typ	Max	Units	Conditions
Drain-to-Source Breakdown Voltage	$BV_{DSS}$	30	-	-	V	$V_{GS} = 0V, I_D = 250\mu A$
Static Drain-Source on Resistance	$R_{DS(on)}$		5.0	6.5	$m\Omega$	$V_{GS} = 4.5V, I_D = 15A$ ②
Gate Threshold Voltage	$V_{GS(th)}$	1.0			V	$V_{DS} = V_{GS}, I_D = 250\mu A$
Drain-Source Leakage Current	$I_{DSS}$			30	$\mu A$	$V_{DS} = 24V, V_{GS} = 0$
				150		$V_{DS} = 24V, V_{GS} = 0,$ $T_j = 100^\circ C$
Gate-Source Leakage Current	$I_{GSS}$			$\pm 100$	nA	$V_{GS} = \pm 12V$
Total Gate Chg Cont FET	$Q_G$		44	60	nC	$V_{GS}=5.0V, I_D=15A, V_{DS}=16V$
Total Gate Chg Sync FET	$Q_G$		38			$V_{GS} = 5.0V, V_{DS} < 100mV$
Pre-Vth Gate-Source Charge	$Q_{GS1}$		13			$V_{DS} = 16V, I_D = 15A$
Post-Vth Gate-Source Charge	$Q_{GS2}$		3.0			
Gate to Drain Charge	$Q_{GD}$		9.0			
Switch Chg( $Q_{gs2} + Q_{gd}$ )	$Q_{sw}$		12			
Output Charge	$Q_{oss}$		27			$V_{DS} = 16V, V_{GS} = 0$
Gate Resistance	$R_G$		1.5		$\Omega$	
Turn-on Delay Time	$t_{d(on)}$		15		ns	$V_{DD} = 16V, I_D = 15A$ $V_{GS} = 5.0V$ Clamped Inductive Load
Rise Time	$t_r$		5.5			
Turn-off Delay Time	$t_{d(off)}$		22			
Fall Time	$t_f$		12			
Input Capacitance	$C_{iss}$	-	5500	-	pF	$V_{DS} = 16V, V_{GS} = 0$
Output Capacitance	$C_{oss}$	-	1000	-		
Reverse Transfer Capacitance	$C_{rss}$	-	300	-		

## Source-Drain Rating & Characteristics

Parameter		Min	Typ	Max	Units	Conditions
Diode Forward Voltage*	$V_{SD}$			1.0	V	$I_S = 15A$ ②, $V_{GS} = 0V$
Reverse Recovery Charge④	$Q_{rr}$		120		nC	$di/dt \sim 700A/\mu s$ $V_{DS} = 16V, V_{GS} = 0V, I_S = 15A$
Reverse Recovery Charge (with Parallel Schottky)④	$Q_{rr(s)}$		108		nC	$di/dt = 700A/\mu s$ (with 10BQ040) $V_{DS} = 16V, V_{GS} = 0V, I_S = 15A$

- Notes:**
- ① Repetitive rating; pulse width limited by max. junction temperature.
  - ② Pulse width  $\leq 400 \mu s$ ; duty cycle  $\leq 2\%$ .
  - ③ When mounted on 1 inch square copper board
  - ④ Typ = measured -  $Q_{oss}$
  - ⑤ Typical values of  $R_{DS(on)}$  measured at  $V_{GS} = 4.5V, Q_G, Q_{sw}$  and  $Q_{oss}$  measured at  $V_{GS} = 5.0V, I_F = 15A$ .

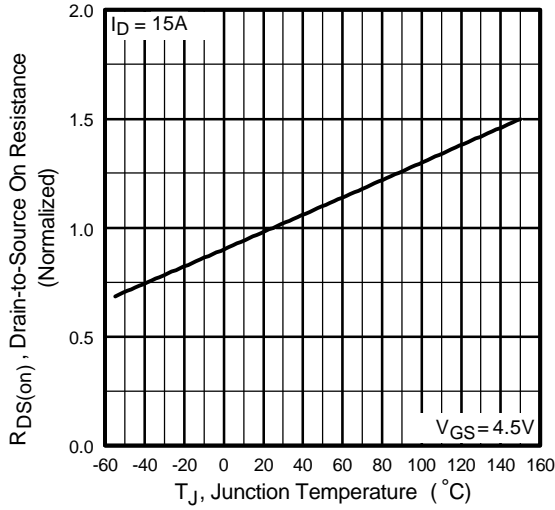

**Fig 1.** Normalized On-Resistance Vs. Temperature

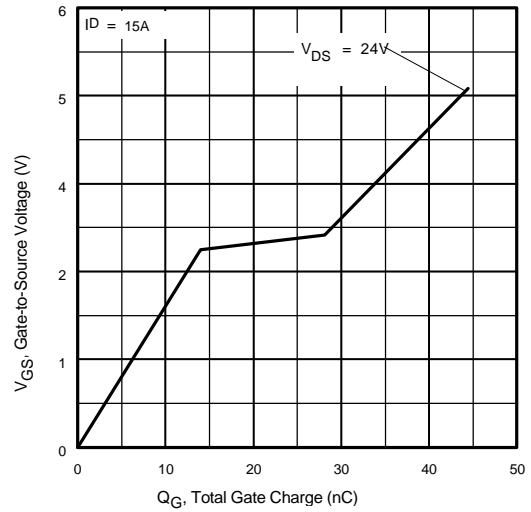

**Fig 2.** Typical Gate Charge Vs. Gate-to-Source Voltage

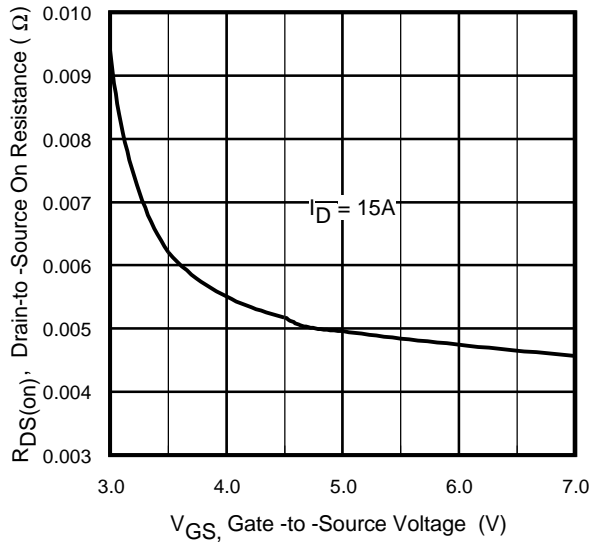

**Fig 3.** On-Resistance Vs. Gate Voltage

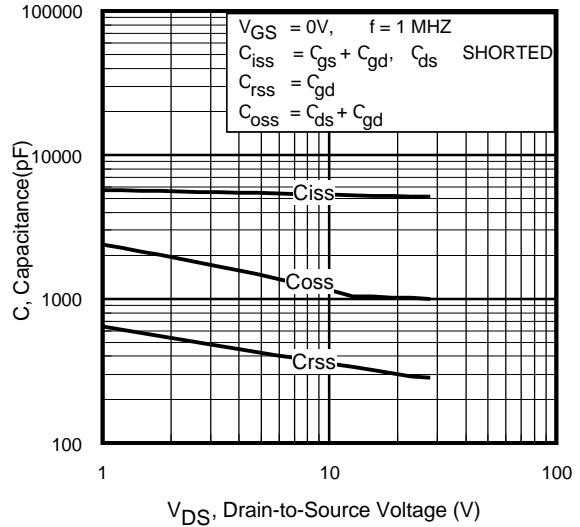

**Fig 4.** Typical Capacitance Vs. Drain-to-Source Voltage

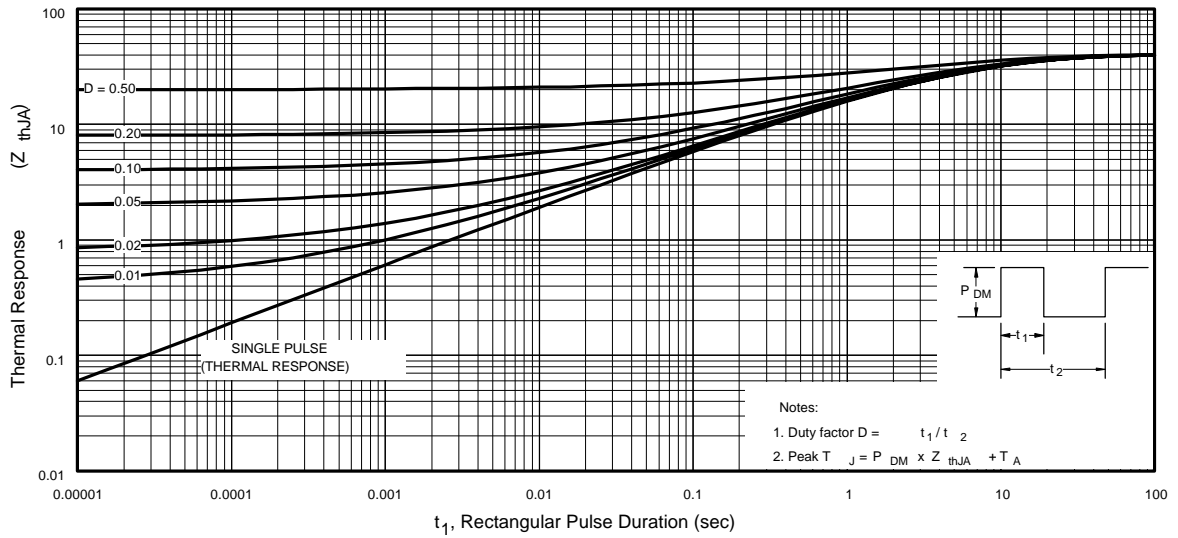
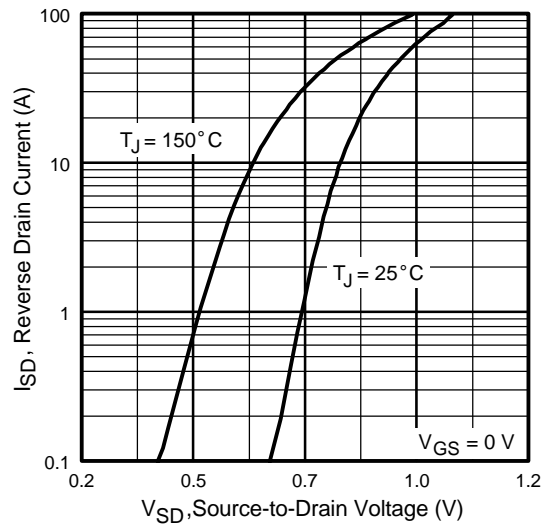
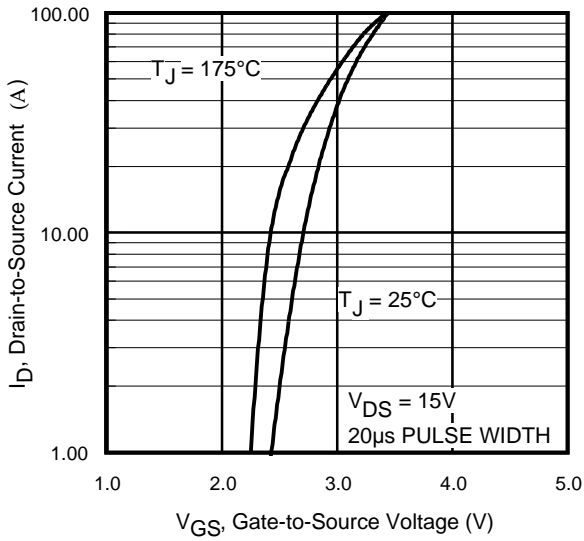

## SO-8 Package Details

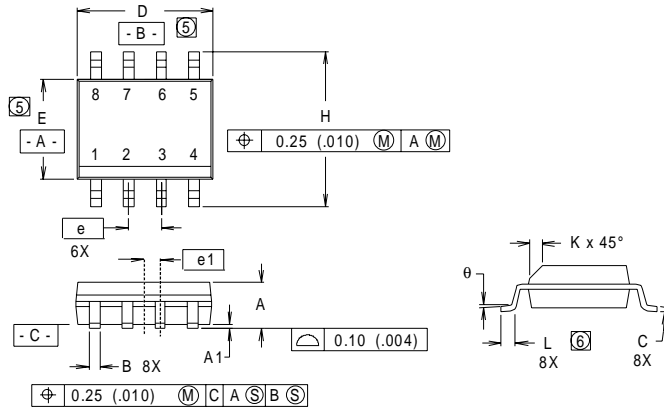

DIM	INCHES		MILLIMETERS	
	MIN	MAX	MIN	MAX
A	.0532	.0688	1.35	1.75
A1	.0040	.0098	0.10	0.25
B	.014	.018	0.36	0.46
C	.0075	.0098	0.19	0.25
D	.189	.196	4.80	4.98
E	.150	.157	3.81	3.99
e	.050 BASIC		1.27 BASIC	
e1	.025 BASIC		0.635 BASIC	
H	.2284	.2440	5.80	6.20
K	.011	.019	0.28	0.48
L	0.16	.050	0.41	1.27
$\theta$	0°	8°	0°	8°

### RECOMMENDED FOOTPRINT

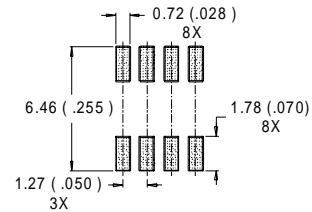

### NOTES:

1. DIMENSIONING AND TOLERANCING PER ANS Y14.5M-1982.
2. CONTROLLING DIMENSION : INCH.
3. DIMENSIONS ARE SHOWN IN MILLIMETERS (INCHES).
4. OUTLINE CONFORMS TO JEDEC OUTLINE MS-012AA.
- ⑤ DIMENSION DOES NOT INCLUDE MOLD PROTRUSIONS  
MOLD PROTRUSIONS NOT TO EXCEED 0.25 (.006).
- ⑥ DIMENSIONS IS THE LENGTH OF LEAD FOR SOLDERING TO A SUBSTRATE..

## SO-8 Part Marking

EXAMPLE: THIS IS AN IRF7101

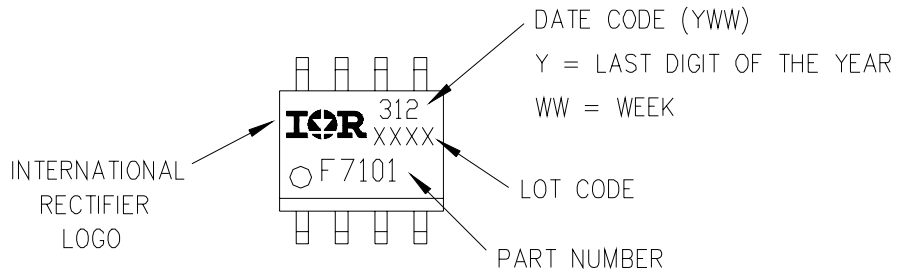

# IRF7822

International  
**IR** Rectifier

## SO-8 Tape and Reel

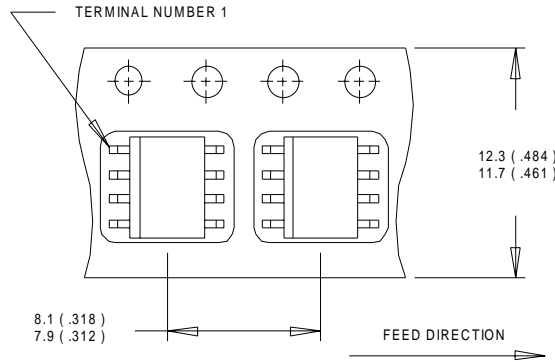

- NOTES:
1. CONTROLLING DIMENSION : MILLIMETER.
  2. ALL DIMENSIONS ARE SHOWN IN MILLIMETERS(INCHES).
  3. OUTLINE CONFORMS TO EIA-481 & EIA-541.

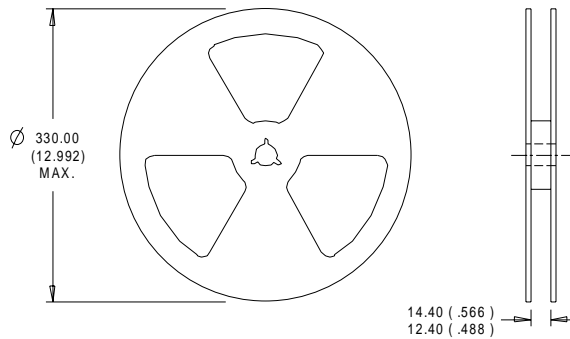

- NOTES :
1. CONTROLLING DIMENSION : MILLIMETER.
  2. OUTLINE CONFORMS TO EIA-481 & EIA-541.

Data and specifications subject to change without notice.  
This product has been designed and qualified for the Consumer market.  
Qualification Standards can be found on IR's Web site.

International  
**IR** Rectifier

IR WORLD HEADQUARTERS: 233 Kansas St., El Segundo, California 90245, USA Tel: (310) 252-7105  
TAC Fax: (310) 252-7903

Visit us at [www.irf.com](http://www.irf.com) for sales contact information.07/01  
[www.irf.com](http://www.irf.com)