

### Product Dimensions

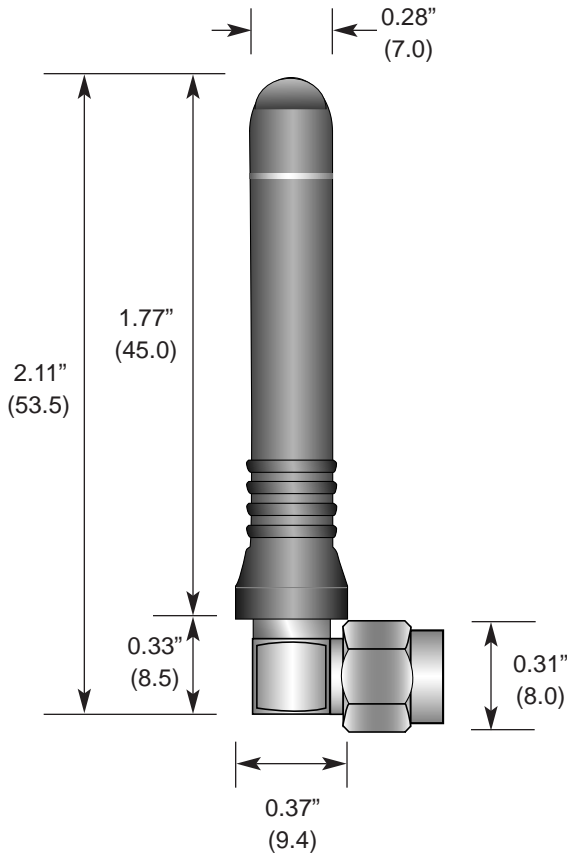

### Description



The RCS Series is ideally suited for products requiring an attractive, yet compact, 1/4-wave antenna in a right-angle form factor. The antennas attach via a Part 15 compliant RP-SMA connector.

### Features

- Reduced height helical whip
- Right-angle mount
- Excellent performance
- Omni-directional pattern
- Fully weatherized
- SMA or Part 15 compliant RP-SMA connector
- Use with plastic\* or metal enclosures

\* Requires proximity ground plane

### Electrical Specifications

- Center Freq. 433MHz
- Bandwidth 20MHz
- Wavelength 1/4-wave
- VSWR <2.0 typ. at center
- Impedance 50 ohms
- Connector RP-SMA

Electrical specifications and plots measured on 4.00" x 4.00" reference ground plane

### Ordering Information

- ANT-433-CW-RCS

### VSWR Graph

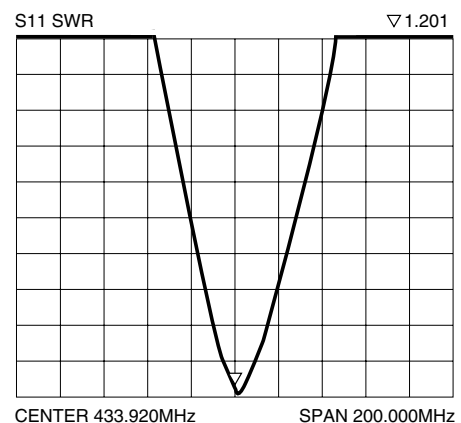

Typical VSWR