



# UK3568

**Power MOSFET**

## SILICON N-CHANNEL MOS TYPE

■ DESCRIPTION

The **UK3568** uses advanced trench technology to provide excellent  $R_{DS(ON)}$ , low gate charge and operation with low gate voltages. This device is suitable for use as a load switch or in PWM applications.

■ FEATURES

- \*  $R_{DS(ON)} = 0.4\Omega$
- \* Low Capacitance
- \* Low Gate Charge
- \* Fast Switching Capability
- \* Avalanche Energy Specified

■ SYMBOL

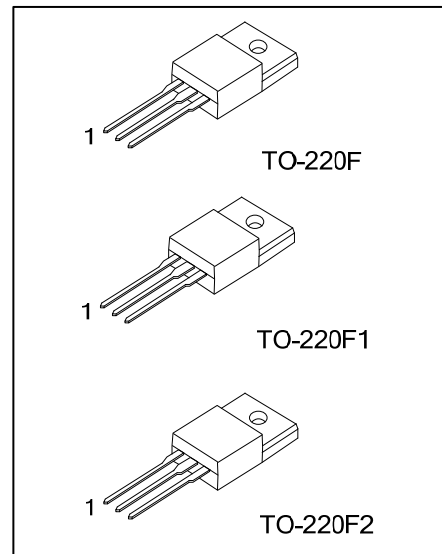
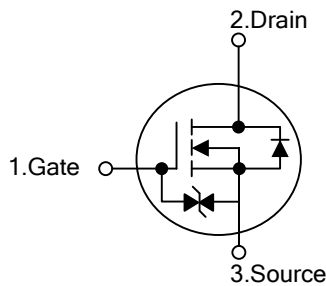

■ ORDERING INFORMATION

Ordering Number		Package	Pin Assignment			Packing
Lead Free	Halogen Free		1	2	3	
UK3568L-TF1-T	UK3568G-TF1-T	TO-220F1	G	D	S	Tube
UK3568L-TF2-T	UK3568G-TF2-T	TO-220F2	G	D	S	Tube
UK3568L-TF3-T	UK3568G-TF3-T	TO-220F	G	D	S	Tube

<p>UK3568L-TF3-T</p>	<p>(1) T: Tube                  (2) TF3: TO-220F, TF1: TO-220F1, TF2: TO-220F2                  (3) G: Halogen Free, L: Lead Free</p>
----------------------	---

■ ABSOLUTE MAXIMUM RATINGS ( $T_A = 25^\circ\text{C}$ , unless otherwise specified)

PARAMETER		SYMBOL	RATINGS	UNIT
Drain-Source Voltage		$V_{DSS}$	500	V
Drain-Gate Voltage ( $R_G=20k\Omega$ )		$V_{DGR}$	500	V
Gate-Source Voltage		$V_{GSS}$	$\pm 30$	V
Continuous Drain Current (Note 2)	DC	$I_D$	12	A
	Pulse( $t=1\text{ms}$ )		48	
Avalanche Current		$I_{AR}$	12	A
Avalanche Energy	Single Pulsed (Note 3)	$E_{AS}$	364	mJ
	Repetitive (Note 4)	$E_{AR}$	4	
Power Dissipation ( $T_C=25^\circ\text{C}$ )	TO-220F/TO-220F1	$P_D$	40	W
	TO-220F2		42	
Junction Temperature		$T_J$	+150	$^\circ\text{C}$
Storage Temperature		$T_{STG}$	-55 ~ +150	$^\circ\text{C}$

Note: 1. Absolute maximum ratings are those values beyond which the device could be permanently damaged.

Absolute maximum ratings are stress ratings only and functional device operation is not implied.

2. Ensure that the temperature will not exceed  $150^\circ\text{C}$ .

3.  $V_{DD}=90\text{V}$ ,  $T_{CH}=25^\circ\text{C}$ (initial),  $L=4.3\text{mH}$ ,  $I_{AR}=12\text{A}$ ,  $R_G=25\Omega$

4. Repetitive rating: pulse width limited by maximum channel temperature

■ THERMAL DATA

PARAMETER		SYMBOL	RATINGS	UNIT
Junction to Ambient		$\theta_{JA}$	62.5	$^\circ\text{C}/\text{W}$
Junction to Case	TO-220F/TO-220F1	$\theta_{JC}$	3.125	$^\circ\text{C}/\text{W}$
	TO-220F2		2.98	

■ ELECTRICAL CHARACTERISTICS ( $T_A=25^\circ\text{C}$ , unless otherwise specified)

PARAMETER	SYMBOL	TEST CONDITIONS	MIN	TYP	MAX	UNIT
<b>OFF CHARACTERISTICS</b>						
Drain-Source Breakdown Voltage	$BV_{DSS}$	$I_D=10\text{mA}$ , $V_{GS}=0\text{V}$	500			V
Drain-Source Leakage Current	$I_{DSS}$	$V_{DS}=500\text{V}$ , $V_{GS}=0\text{V}$			100	$\mu\text{A}$
Gate-Source Leakage Current	$I_{GSS}$	$V_{DS}=0\text{V}$ , $V_{GS}=\pm 25\text{V}$			$\pm 10$	$\mu\text{A}$
<b>ON CHARACTERISTICS</b>						
Gate-Source Breakdown Voltage	$BV_{GSS}$	$I_G=\pm 10\mu\text{A}$ , $V_{DS}=0\text{V}$	$\pm 30$			V
Gate Threshold Voltage	$V_{GS(TH)}$	$V_{DS}=10\text{V}$ , $I_D=1\text{mA}$	2.0		4.0	V
On State Drain Current	$I_{D(ON)}$					A
Static Drain-Source On-Resistance	$R_{DS(ON)}$	$V_{GS}=10\text{V}$ , $I_D=6\text{A}$		0.4	0.52	$\Omega$
<b>DYNAMIC PARAMETERS</b>						
Input Capacitance	$C_{ISS}$	$V_{DS}=25\text{V}$ , $V_{GS}=0\text{V}$ , $f=1\text{MHz}$		1500		pF
Output Capacitance	$C_{OSS}$			180		pF
Reverse Transfer Capacitance	$C_{RSS}$			15		pF
<b>SWITCHING PARAMETERS</b>						
Total Gate Charge	$Q_G$	$V_{DS}\approx 400\text{V}$ , $V_{GS}=10\text{V}$ , $I_D=12\text{A}$		42		nC
Gate Source Charge	$Q_{GS}$			23		nC
Gate Drain Charge	$Q_{GD}$			19		nC
Turn-ON Delay Time	$t_{D(ON)}$	$V_{GS}=10\text{V}$ , $V_{DD}\approx 200\text{V}$ , $R_L=33\Omega$ , $I_D=6\text{A}$		50	88	ns
Turn-ON Rise Time	$t_R$			22	176	ns
Turn-OFF Delay Time	$t_{D(OFF)}$			170	416	ns
Turn-OFF Fall-Time	$t_F$			36	232	ns
<b>SOURCE- DRAIN DIODE RATINGS AND CHARACTERISTICS</b>						
Diode Forward Voltage	$V_{SD}$	$I_{DR}=12\text{A}$ , $V_{GS}=0\text{V}$			1.7	V
Continuous Drain Reverse Current	$I_D$				12	A
Pulse Drain Reverse Current	$I_{DR}$				48	A
Reverse Recovery Time	$t_{rr}$	$I_{DR}=12\text{A}$ , $V_{GS}=0\text{V}$ ,		1200		ns
Reverse Recovery Charge	$Q_{RR}$	$dI/dt=100\text{A}/\mu\text{s}$		16		$\mu\text{C}$

## TYPICAL CHARACTERISTICS

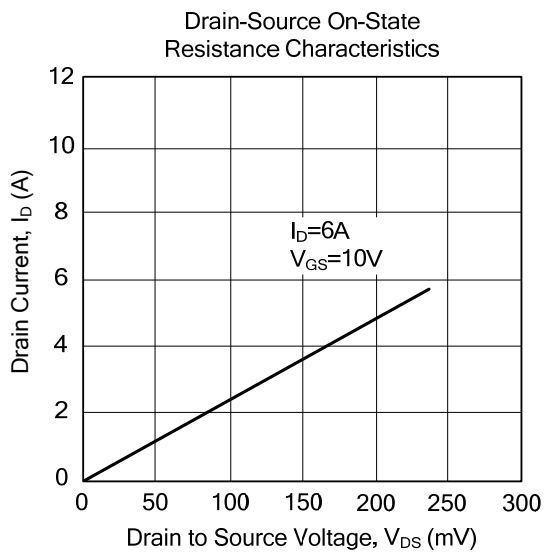
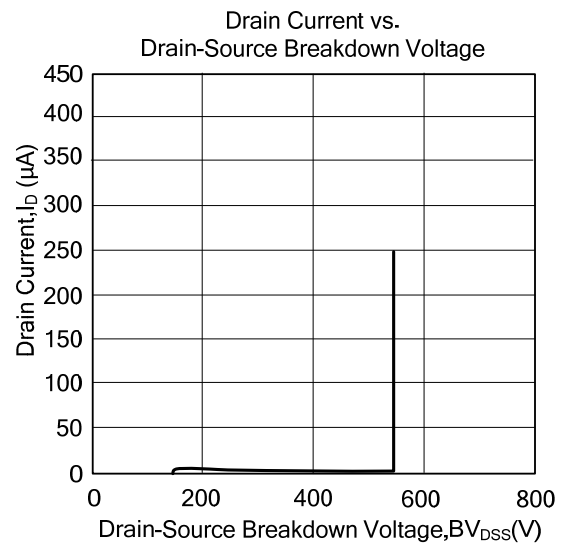
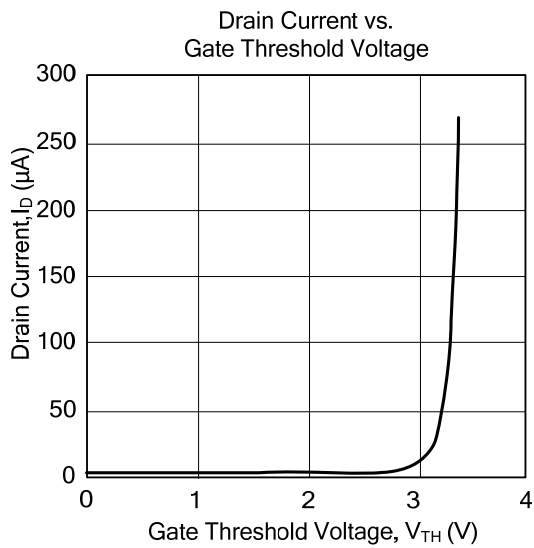
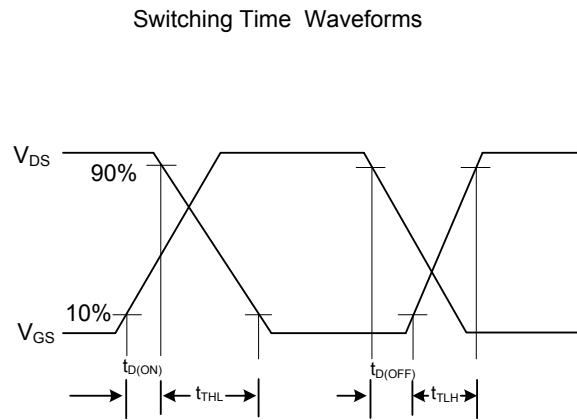
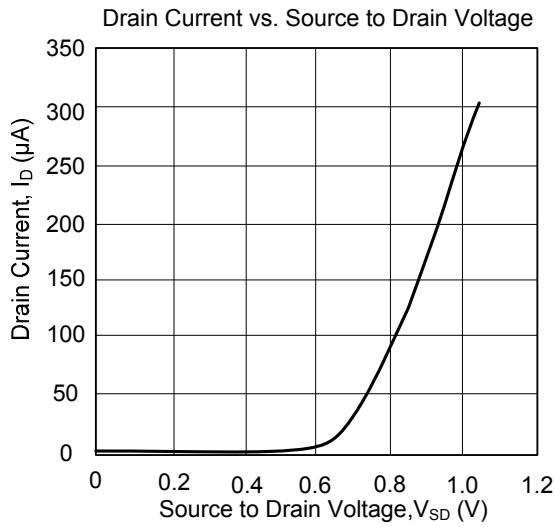

UTC assumes no responsibility for equipment failures that result from using products at values that exceed, even momentarily, rated values (such as maximum ratings, operating condition ranges, or other parameters) listed in products specifications of any and all UTC products described or contained herein. UTC products are not designed for use in life support appliances, devices or systems where malfunction of these products can be reasonably expected to result in personal injury. Reproduction in whole or in part is prohibited without the prior written consent of the copyright owner. The information presented in this document does not form part of any quotation or contract, is believed to be accurate and reliable and may be changed without notice.