

Aug.1.2021 Copyright 2021 HIROSE ELECTRIC CO., LTD. All Rights Reserved.
In case of consideration for using Automotive equipment / device which demand high reliability, kindly contact our sales window correspondents.

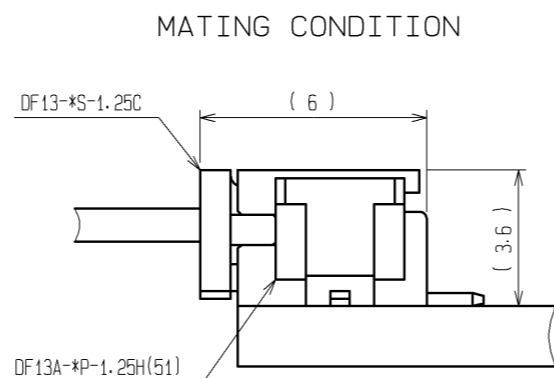

CODE No.	PARTS No.	NUMBER OF CONTACT	A	B	C	D
CL536-0301-8-51	DF13A- 2P-1.25H(51)	2	1.25	4.15	7.15	5.65
CL536-0302-0-51	DF13A- 3P-1.25H(51)	3	2.50	5.40	8.40	6.90
CL536-0303-3-51	DF13A- 4P-1.25H(51)	4	3.75	6.65	9.65	8.15
CL536-0304-6-51	DF13A- 5P-1.25H(51)	5	5.00	7.90	10.90	9.40
CL536-0305-9-51	DF13A- 6P-1.25H(51)	6	6.25	9.15	12.15	10.65
CL536-0306-1-51	DF13A- 7P-1.25H(51)	7	7.50	10.40	13.40	11.90
CL536-0307-4-51	DF13A- 8P-1.25H(51)	8	8.75	11.65	14.65	13.15
CL536-0308-7-51	DF13A- 9P-1.25H(51)	9	10.00	12.90	15.90	14.40
CL536-0309-0-51	DF13A-10P-1.25H(51)	10	11.25	14.15	17.15	15.65
CL536-0310-9-51	DF13A-11P-1.25H(51)	11	12.50	15.40	18.40	16.90
CL536-0311-1-51	DF13A-12P-1.25H(51)	12	13.75	16.65	19.65	18.15
CL536-0313-7-51	DF13A-14P-1.25H(51)	14	16.25	19.15	22.15	20.65
CL536-0314-0-51	DF13A-15P-1.25H(51)	15	17.50	20.40	23.40	21.90

6 RECOMMENDED PATTERN

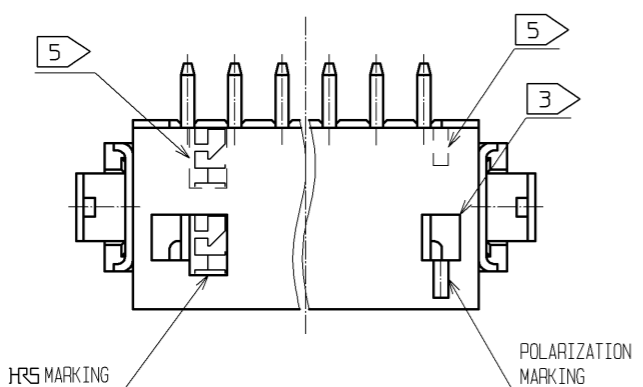
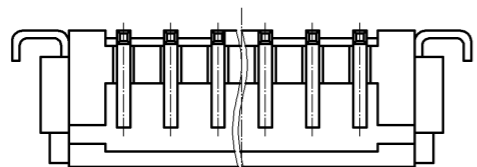
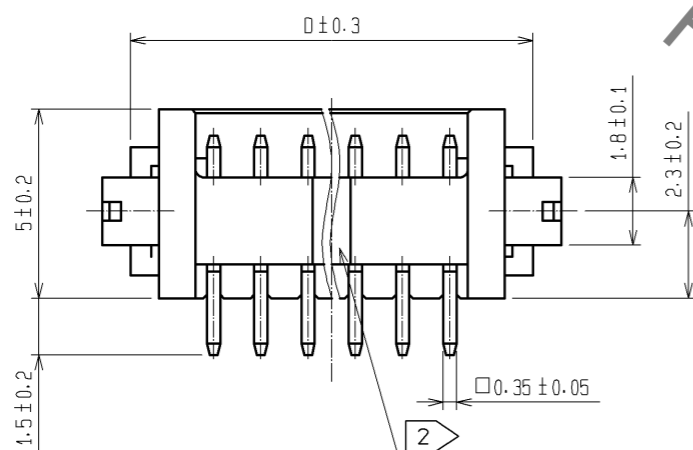
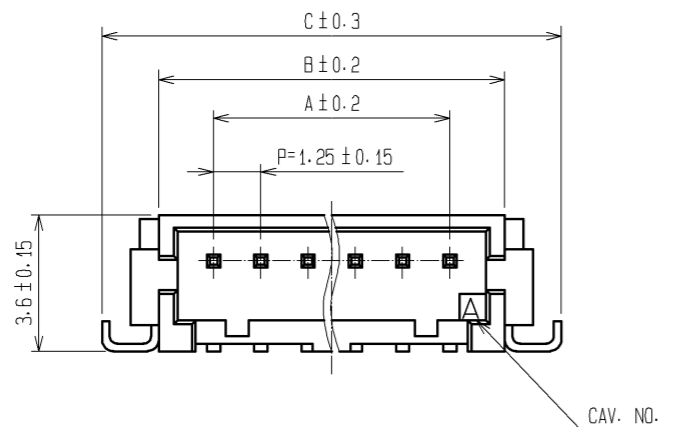
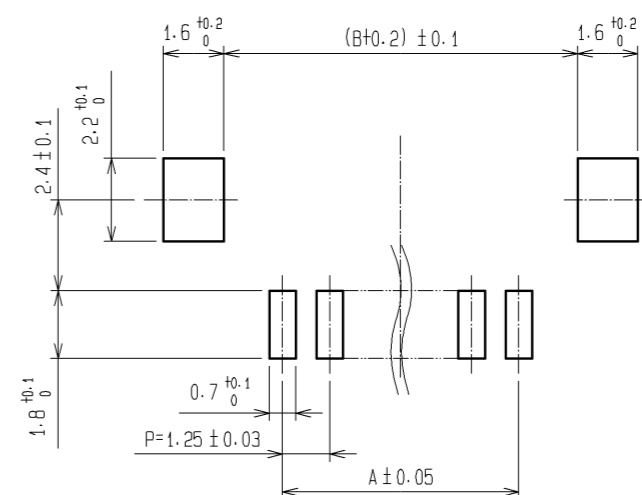

- NOTE 1 : WHEN THIS CONNECTOR MATES WITH DF13-*S-1.25C THE MATING LENGTH IS 3.6 mm.
- 2 : THERE SHALL BE STANDOFF MORE THAN FIVE CONTACTS.
- 3 : WHEN THIS CONNECTOR HAS TWO OR THREE CONTACTS, THE LOCK SHALL BE SET AT THE CENTER OF HOUSING. IF MORE THAN FOUR, THE TWO LOCKS SHALL BE SET AS SHOWN ON THIS DRAWING.
- 4 : FLATNESS OF LEAD WITH REINFORCED METAL FITTINGS SHALL BE WITHIN 0.1mm.
- 5 : WHEN THIS CONNECTOR HAS MORE THAN SEVEN CONTACTS, HRS MARKING AND POLARIZATION MARKING SHIFT TO THE PLACE INDICATING DOTTED LINES.
- 6 : RECOMMENDED METAL MASK THICKNESS: 0.15-0.2mm
OPEN AREA RATIO: 100%

3	PHOSPHOR BRONZE	SURFACE : TIN PLATED 1μm min.	5	POLYESTER	COVER TAPE, CLEAR
2	BRASS	SURFACE : GOLD PLATED 0.2μm min. UNDER : NICKEL PLATED 0.5μm min.	4	PS	EMBOSSED CARRIER TAPE, CLEAR
1	POLYAMIDE	BEIGE (UL94V-0)			
NO.	MATERIAL	FINISH, REMARKS	NO.	MATERIAL	FINISH, REMARKS
UNITS mm		SCALE 5 : 1	COUNT △	DESCRIPTION OF REVISIONS	
DESIGNED		CHECKED		DATE	
APPROVED : TS. SAKATA 09.08.21			DRAWING NO. EDC3-162444-08		
CHECKED : TS. FUKUSHIMA 09.08.21			PART NO. DF13A-*P-1.25H(51)		
DESIGNED : SN. KOBAYASHI 09.08.20			CODE NO. CL536-		
DRAWN : YK. NAKATSU 09.06.19			△ 1/2		

Aug.1.2021 Copyright 2021 HIROSE ELECTRIC CO., LTD. All Rights Reserved.
 In case of consideration for using Automotive equipment / device which demand high reliability, kindly contact our sales window correspondents.

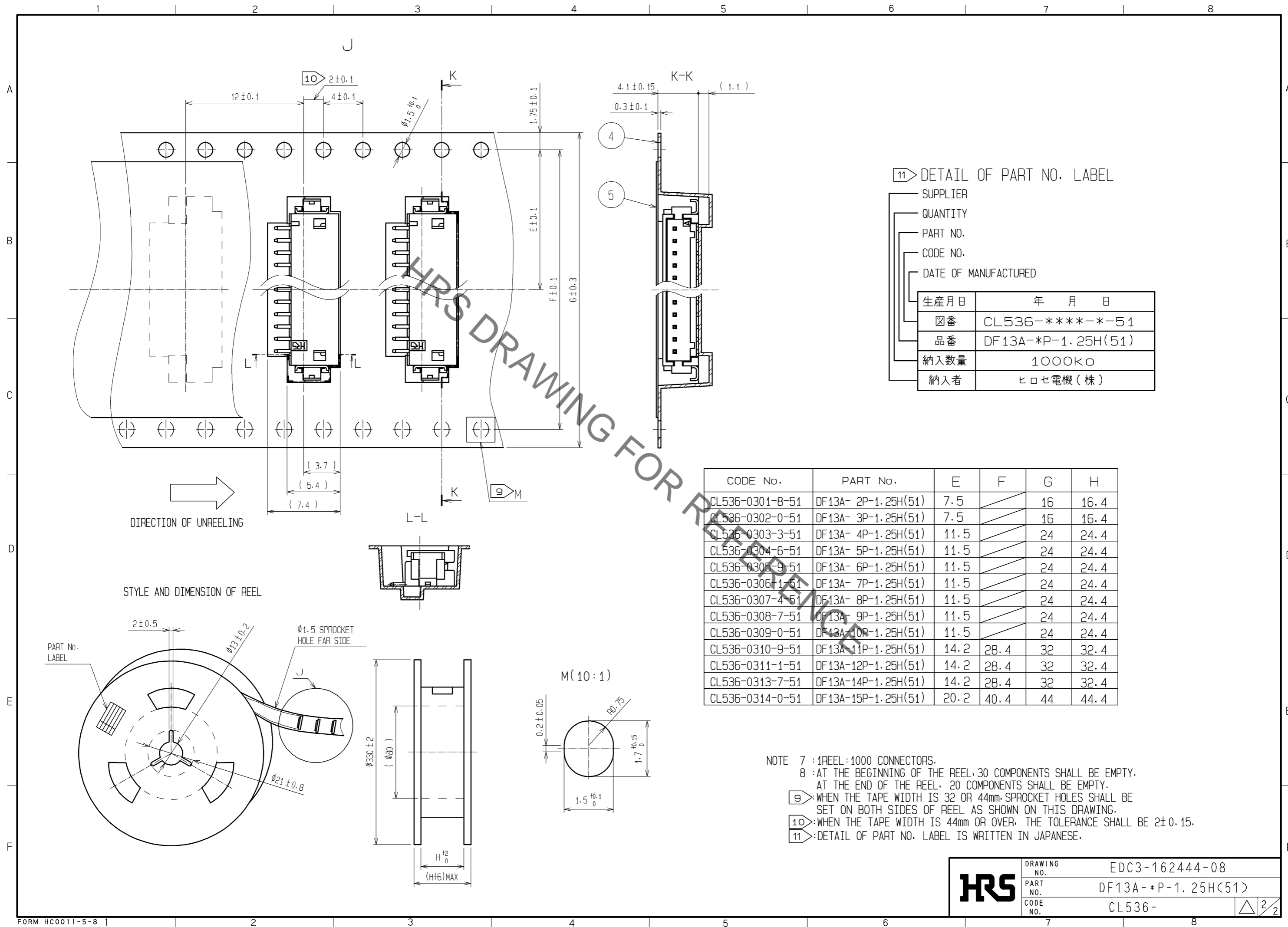

11) DETAIL OF PART NO. LABEL

SUPPLIER	
QUANTITY	
PART NO.	
CODE NO.	
DATE OF MANUFACTURED	
生産月日	年 月 日
図番	CL536-****-*-51
品番	DF13A-*P-1.25H(51)
納入数量	1000K ϕ
納入者	ヒロセ電機(株)

CODE No.	PART No.	E	F	G	H
CL536-0301-8-51	DF13A- 2P-1.25H(51)	7.5		16	16.4
CL536-0302-0-51	DF13A- 3P-1.25H(51)	7.5		16	16.4
CL536-0303-3-51	DF13A- 4P-1.25H(51)	11.5		24	24.4
CL536-0304-6-51	DF13A- 5P-1.25H(51)	11.5		24	24.4
CL536-0305-9-51	DF13A- 6P-1.25H(51)	11.5		24	24.4
CL536-0306-1-51	DF13A- 7P-1.25H(51)	11.5		24	24.4
CL536-0307-4-51	DF13A- 8P-1.25H(51)	11.5		24	24.4
CL536-0308-7-51	DF13A- 9P-1.25H(51)	11.5		24	24.4
CL536-0309-0-51	DF13A-10P-1.25H(51)	11.5		24	24.4
CL536-0310-9-51	DF13A-11P-1.25H(51)	14.2	28.4	32	32.4
CL536-0311-1-51	DF13A-12P-1.25H(51)	14.2	28.4	32	32.4
CL536-0313-7-51	DF13A-14P-1.25H(51)	14.2	28.4	32	32.4
CL536-0314-0-51	DF13A-15P-1.25H(51)	20.2	40.4	44	44.4

NOTE 7 : 1REEL : 1000 CONNECTORS.
 8 : AT THE BEGINNING OF THE REEL, 30 COMPONENTS SHALL BE EMPTY.
 AT THE END OF THE REEL, 20 COMPONENTS SHALL BE EMPTY.
 9 : WHEN THE TAPE WIDTH IS 32 OR 44mm, SPROCKET HOLES SHALL BE SET ON BOTH SIDES OF REEL AS SHOWN ON THIS DRAWING.
 10 : WHEN THE TAPE WIDTH IS 44mm OR OVER, THE TOLERANCE SHALL BE 2±0.15.
 11 : DETAIL OF PART NO. LABEL IS WRITTEN IN JAPANESE.

HRS	DRAWING NO.	EDC3-162444-08
	PART NO.	DF13A-*P-1.25H(51)
	CODE NO.	CL536-

2/2