

DATA SHEET

SKY65173-70LF: 869 to 960 MHz Low-Noise Linear Power Amplifier Driver

Applications

- 2.5G, 3G, and 4G transceivers
- ISM band transceivers
- WCS fixed wireless
- 3GPP LTE

Features

- Wideband frequency range: 869 to 960 MHz
- Low Noise Figure: < 2.6 dB typical
- High IIP3: > +44 dBm typical
- Output P1dB: +26.5 dBm typical
- High gain: > 16.5 dB typical
- Single DC supply: +5 V
- On-chip bias circuit
- SOT-89 (4-pin, 2.4 x 4.5 mm) package (MSL1, 260 °C per JEDEC J-STD-020)



Skyworks Green™ products are compliant with all applicable legislation and are halogen-free. For additional information, refer to *Skyworks Definition of Green™*, document number SQ04-0074.

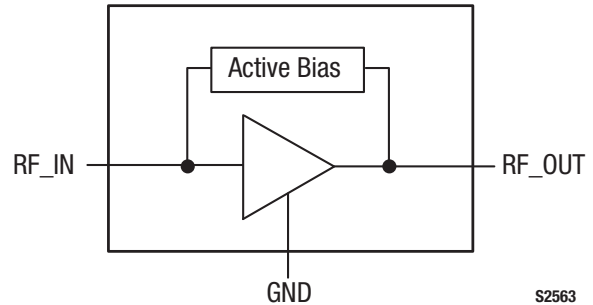

Figure 1. SKY65173-70LF Functional Block Diagram

Description

Skyworks SKY65173-70LF is a high performance, wideband, low-noise, highly linear Power Amplifier (PA) driver. The device provides a 2.6 dB Noise Figure (NF) and an output power at 1 dB compression of +26.5 dBm, making the SKY65173-70LF ideal for use in the driver stage of infrastructure transmit chains.

The SKY65173-70LF uses low-cost surface-mount technology (SMT) in the form of a 4-pin, 2.4 x 4.5 mm Small Outline Transistor (SOT-89) package. A functional block diagram is provided in Figure 1 and the device package and pinout are shown in Figure 2.

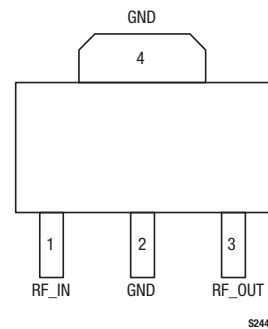

Figure 2. SKY65173-70LF Pinout Package (Top View)

Table 1. SKY65173-70LF Signal Descriptions

| Pin | Name | Description |
|-----|--------|-------------|
| 1 | RF_IN | RF input |
| 2 | GND | Ground |
| 3 | RF_OUT | RF output |
| 4 | GND | Ground |

Table 2. SKY65173-70LF Absolute Maximum Ratings¹

| Parameter | Symbol | Min | Max | Units |
|----------------------------|-----------------|-----|------|-------|
| Supply voltage | V _{CC} | | 6 | V |
| RF input power | P _{IN} | | +10 | dBm |
| Supply current | I _{CC} | | 300 | mA |
| Power dissipation | P _D | | 1.7 | W |
| Operating case temperature | T _C | -40 | +85 | °C |
| Storage temperature | T _{ST} | -55 | +125 | °C |
| Junction temperature | T _J | | +150 | °C |
| Thermal resistance | Θ _{JC} | | 29 | °C/W |

¹ Exposure to maximum rating conditions for extended periods may reduce device reliability. There is no damage to device with only one parameter set at the limit and all other parameters set at or below their nominal values. Exceeding any of the limits listed here may result in permanent damage to the device.

ESD HANDLING: *Although this device is designed to be as robust as possible, electrostatic discharge (ESD) can damage this device. This device must be protected at all times from ESD when handling or transporting. Static charges may easily produce potentials of several kilovolts on the human body or equipment, which can discharge without detection. Industry-standard ESD handling precautions should be used at all times.*

Table 3. SKY65173-70LF Recommended Operating Conditions

| Parameter | Symbol | Min | Typ | Max | Units |
|----------------------------|-----------------|------|-----|------|-------|
| Supply voltage | V _{CC} | 4.75 | 5.0 | 5.5 | V |
| Operating frequency | f | 850 | | 1000 | MHz |
| Operating case temperature | T _C | -40 | +25 | +85 | °C |

Electrical and Mechanical Specifications

Signal pin assignments and functional pin descriptions are described in Table 1. The absolute maximum ratings of the SKY65173-70LF are provided in Table 2. The recommended operating conditions are specified in Table 3 and electrical specifications are provided in Table 4.

Typical performance characteristics of the SKY65173-70LF are illustrated in Figures 3 to 13.

Table 4. SKY65173-70LF Electrical Characteristics¹
(V_{CC} = +5 V, T_c = 25 °C, f = 920 MHz, Unless Otherwise Noted)

| Parameter | Symbol | Test Conditions | Min | Typ | Max | Units |
|------------------------------------|------------------|---|-------|-------|------|-------|
| Frequency | f | | 869 | 920 | 960 | MHz |
| Quiescent current | I _{CCQ} | | 130 | 156 | 185 | mA |
| Operational current | I _{OP} | @P1dB | | 235 | 300 | mA |
| Input return loss | IS11l | | 10 | 13 | | dB |
| Small signal gain | IS21l | | 15.0 | 16.5 | 17.5 | dB |
| Output return loss | IS22l | | 10 | 15 | | dB |
| Third Order Output Intercept Point | OIP3 | P _{IN} = -10 dBm, 1 MHz spacing | +41 | +44 | | dBm |
| Noise figure | NF | | | 2.6 | 3.0 | dB |
| 1 dB compression point | P1dB | | +25.5 | +26.5 | | dBm |

¹ Performance is guaranteed only under the conditions listed in this table.

Typical Performance Characteristics

(V_{CC} = +5 V, T_c = 25 °C, f = 920 MHz, Characteristic Impedance [Z₀] = 50 Ω, Unless Otherwise Noted)

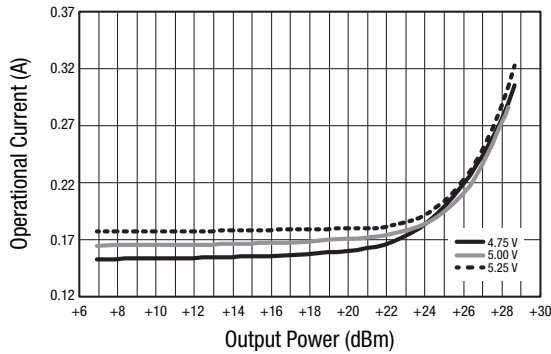

Figure 3. Operational Current vs Output Power Over Supply Voltage

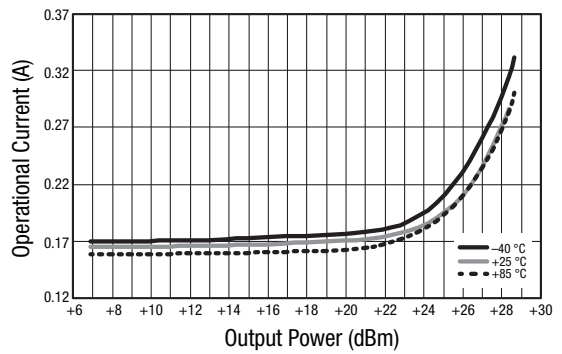

Figure 4. Operational Current vs Output Power Over Temperature

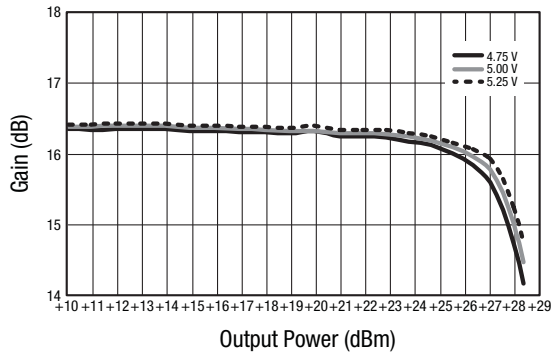

Figure 5. Gain vs Output Power Over Supply Voltage

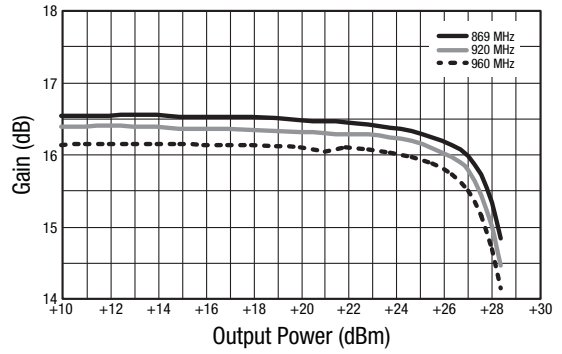

Figure 6. Gain vs Output Power Over Frequency

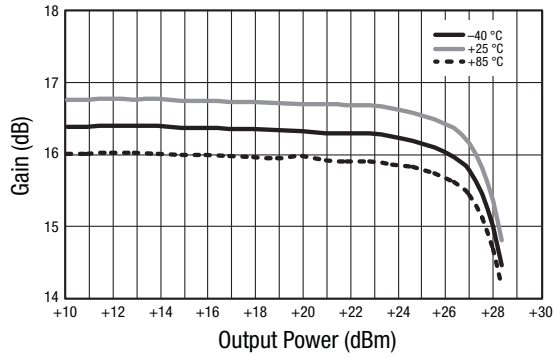

Figure 7. Gain vs Output Power Over Temperature

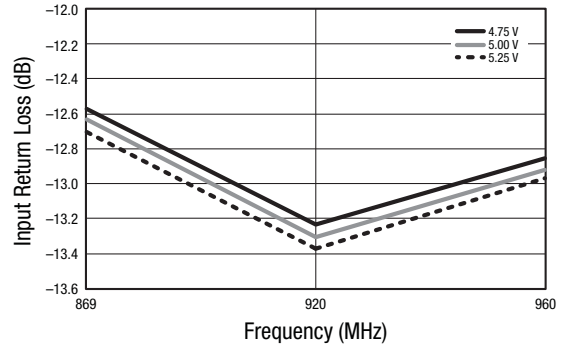

Figure 8. Input Return Loss vs Frequency Over Supply Voltage

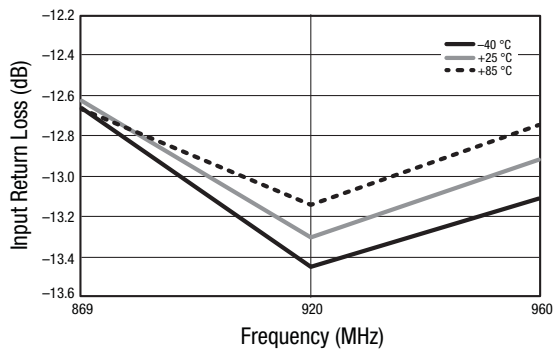

Figure 9. Input Return Loss vs Frequency Over Temperature

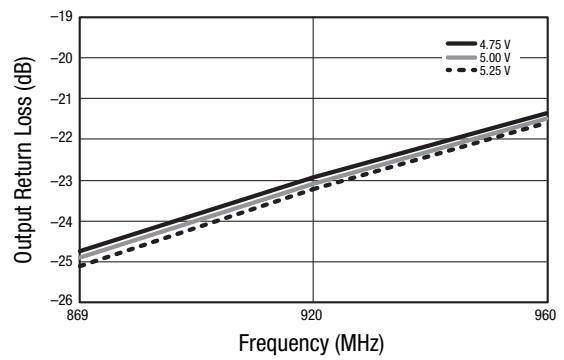

Figure 10. Output Return Loss vs Frequency Over Supply Voltage

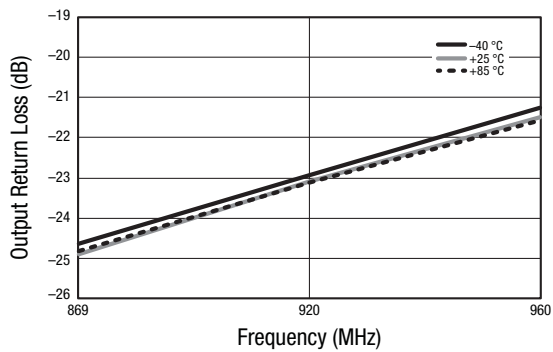

Figure 11. Output Return Loss vs Frequency Over Temperature

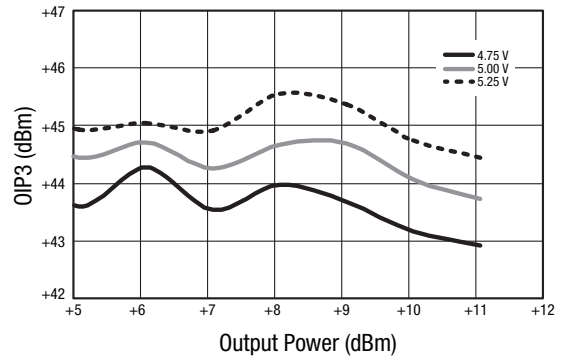

Figure 12. OIP3 vs Output Power Over Supply Voltage

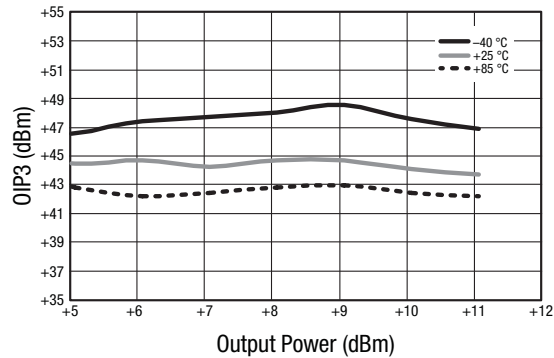

Figure 13. OIP3 vs Output Power Over Temperature

Evaluation Board Description

The Skyworks SKY65173-70LF Evaluation Board is used to test the performance of the SKY65173-70LF PA driver. An assembly drawing for the Evaluation Board is shown in Figure 14, and the BOM components are listed in Table 5. Board layer detail is provided in Figure 15. The layer detail physical characteristics are noted in Figure 16.

As shown in Figure 17, capacitors C7, C8, and C9 provide DC bias decoupling for Vcc. Pins 1 and 3 are the RF input and output signals, respectively. External DC blocking is required on the input and output, but can be implemented as part of the RF matching circuit. Pin 2 and the package backside metal, pin 4, are ground pins that provide the DC and RF ground, respectively.

Testing Procedure

Use the following procedure to set up the SKY65173-70LF Evaluation Board for testing:

1. Connect a 5.0 V supply to Vcc. If available, enable the current limiting function of the power supply to 400 mA.
2. Connect a signal generator to the RF signal input port. Set it to the desired RF frequency at a power level of -15 dBm or less to the Evaluation Board but do NOT enable the RF signal.
3. Connect a spectrum analyzer to the RF signal output port.
4. Enable the power supply.
5. Enable the RF signal.
6. Take measurements.

CAUTION: *If any of the output signals exceed the rated maximum values, the SKY65173-70LF Evaluation Board can be permanently damaged.*

Circuit Design Considerations

The following design considerations are general in nature and must be followed regardless of final use or configuration.

- Paths to ground should be made as short as possible.
- The ground pad of the SKY65173-70LF PA has special electrical and thermal grounding requirements. This pad is the main thermal conduit for heat dissipation. Since the circuit board acts as the heat sink, it must shunt as much heat as possible from the amplifier. As such, design the connection to the ground pad to dissipate the maximum wattage produced to the circuit board. Multiple vias to the grounding layer are required.

NOTE: *Junction temperature (T_j) of the device increases with a poor connection to the slug and ground. This reduces the lifetime of the device.*

A suggested matching circuit is shown in Figure 17.

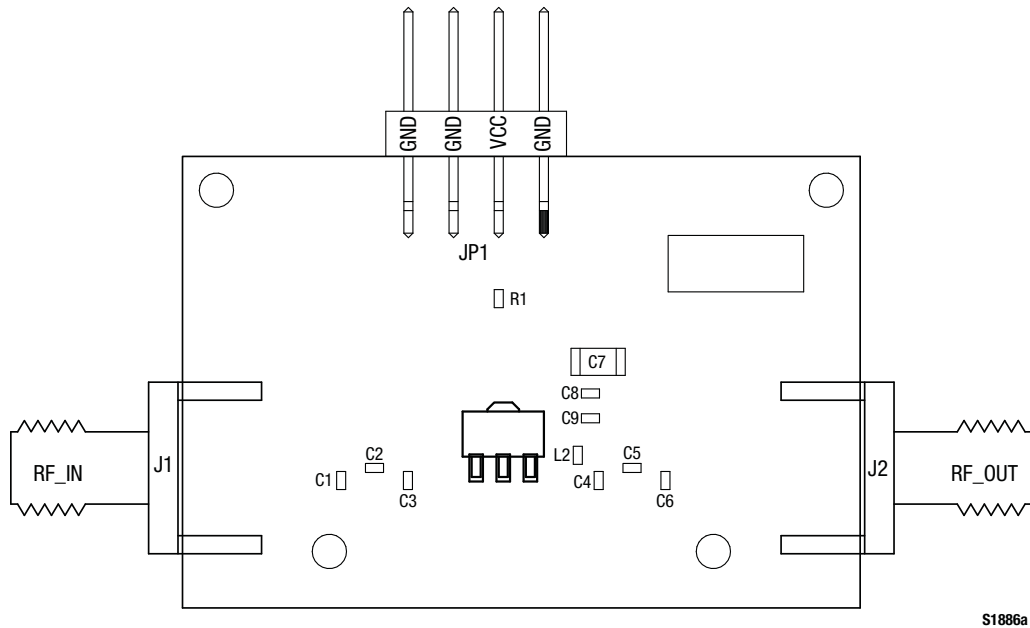
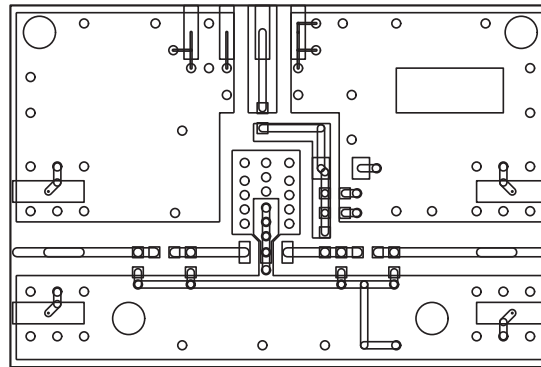

Figure 14. Evaluation Board Assembly Drawing

S1886a

Table 5. SKY65173-70LF Evaluation Board Bill of Materials

| Component | Size | Value | Vendor | Notes |
|-----------|------|---------|----------|--|
| C1 | 0402 | 4.3 nH | Murata | Wire wound, hi-Q inductor, ±0.1 nH tolerance |
| C2 | 0402 | 4.3 pF | Johanson | Wire wound, hi-Q capacitor, low ESR, ±0.1 pF tolerance |
| C3 | 0402 | DNI | - | |
| C4 | 0402 | DNI | - | |
| C5 | 0402 | 4.3 pF | Johanson | Wire wound, hi-Q capacitor, low ESR, ±0.1 pF tolerance |
| C6 | 0402 | 5.1 nH | Murata | Wire wound, hi-Q inductor, ±0.1 nH tolerance |
| C7 | 1206 | 1 µF | - | Ceramic capacitor, 10% tolerance |
| C8 | 0402 | DNI | - | |
| C9 | 0402 | 1000 pF | - | Ceramic capacitor, 10% tolerance |
| L2 | 0402 | 8.2 nH | Murata | Wire wound, hi-Q inductor, 2% tolerance |
| R1 | 0402 | 0 Ω | - | |



Layer 1: Top - Metal

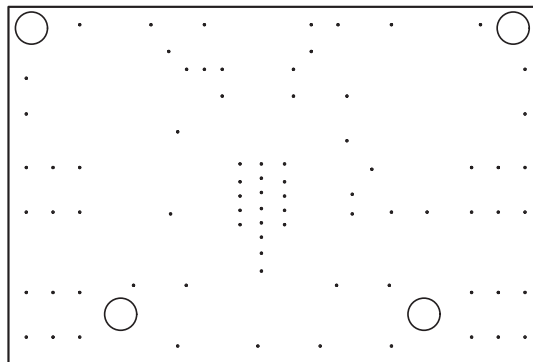

Layer 2: Ground

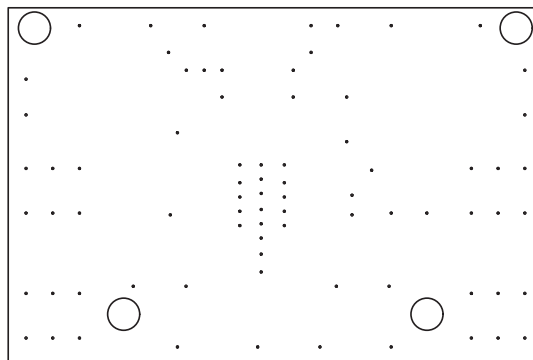

Layer 3: Ground

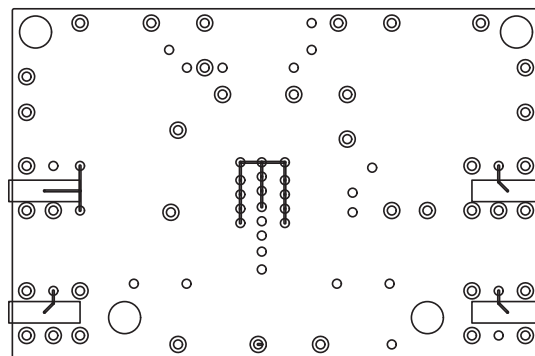

Layer 4: Solid Ground Plane

5709

Figure 15. Evaluation Board Layer Detail

| Cross Section | Name | Thickness (mils) | Material | ϵ_r |
|---------------|------|------------------|----------------|--------------|
| | L1 | 1.4 | Cu, 1 oz. | - |
| | Lam1 | 12 | Rogers 4003-12 | 3.38 |
| | L2 | 1.4 | Cu, 1 oz. | - |
| | Lam2 | 4 | FR4-4 | 4.35 |
| | L3 | 1.4 | Cu, 1 oz. | - |
| | Lam3 | 12 | FR4-12 | 4.35 |
| | L4 | 1.4 | Cu, 1 oz. | - |

S573

Figure 16. Layer Detail Physical Characteristics

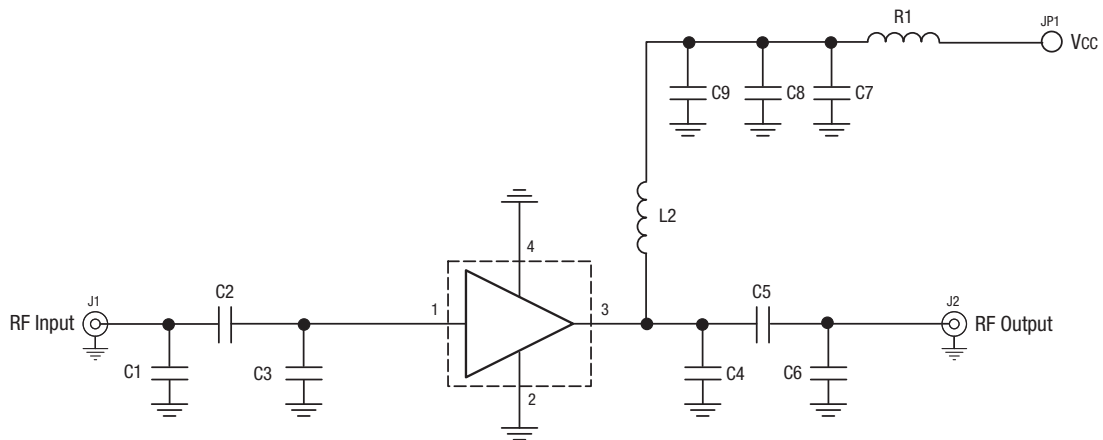

NOTE: Some component labels may be different than the corresponding component symbol shown here. Component values, however, are accurate as of the date of this Data Sheet.

S1882b

Figure 17. SKY65173-70LF Evaluation Board Schematic

Package and Handling Information

Instructions on the shipping container label regarding exposure to moisture after the container seal is broken must be followed. Otherwise, problems related to moisture absorption may occur when the part is subjected to high temperature during solder assembly.

The SKY65173-70LF is rated to Moisture Sensitivity Level 1 (MSL1) at 260 °C. It can be used for lead or lead-free soldering. For additional information, refer to the Skyworks Application Note, *Solder Reflow Information*, document number 200164.

Care must be taken when attaching this product, whether it is done manually or in a production solder reflow environment. Production quantities of this product are shipped in a standard tape and reel format.

Package Dimensions

Package dimensions are shown in Figure 18, and tape and reel dimensions are provided in Figure 19.

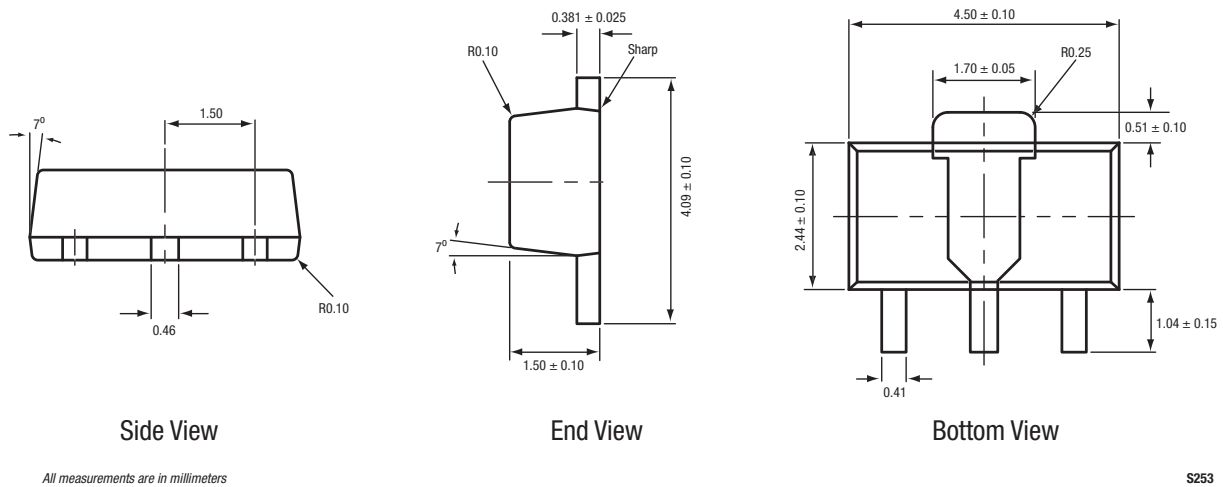
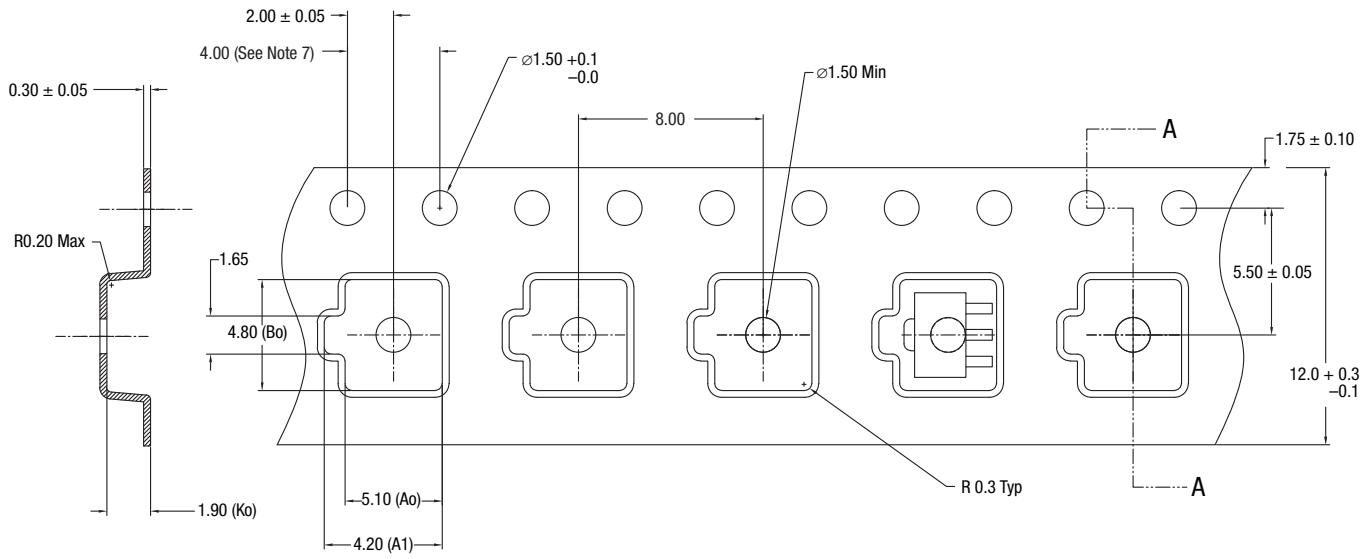

Figure 18. SKY65173-70LF Package Dimensions

DATA SHEET • SKY65173-70LF: PA DRIVER



Notes:

1. Carrier tapes must meet all requirements of Skyworks GP01-D233 procurement spec for tape and reel shipping.
2. Carrier tape material: black conductive polycarbonate or polystyrene.
3. Cover tape material: transparent conductive PSA.
Cover tape size: 9.2 mm width.
4. Typical ESD surface resistivity must meet all ESD requirements of Skyworks specified in GP01-D233.
5. Ao and Bo measurement point to be 0.30 mm from bottom pocket.
6. All measurements are in millimeters.
7. 10-sprocket hole pitch cumulative tolerance 0.2 mm.

200953-100

Figure 19. SKY65173-70LF Tape and Reel Dimensions

Ordering Information

| Model Name | Ordering Part Number | Evaluation Board Part Number |
|-----------------------------------|----------------------|------------------------------|
| SKY65173-70LF Low-Noise PA Driver | SKY65173-70LF | SKY65173-70LF-EVB |

Copyright © 2012, 2016, 2017 Skyworks Solutions, Inc. All Rights Reserved.

Information in this document is provided in connection with Skyworks Solutions, Inc. (“Skyworks”) products or services. These materials, including the information contained herein, are provided by Skyworks as a service to its customers and may be used for informational purposes only by the customer. Skyworks assumes no responsibility for errors or omissions in these materials or the information contained herein. Skyworks may change its documentation, products, services, specifications or product descriptions at any time, without notice. Skyworks makes no commitment to update the materials or information and shall have no responsibility whatsoever for conflicts, incompatibilities, or other difficulties arising from any future changes.

No license, whether express, implied, by estoppel or otherwise, is granted to any intellectual property rights by this document. Skyworks assumes no liability for any materials, products or information provided hereunder, including the sale, distribution, reproduction or use of Skyworks products, information or materials, except as may be provided in Skyworks Terms and Conditions of Sale.

THE MATERIALS, PRODUCTS AND INFORMATION ARE PROVIDED “AS IS” WITHOUT WARRANTY OF ANY KIND, WHETHER EXPRESS, IMPLIED, STATUTORY, OR OTHERWISE, INCLUDING FITNESS FOR A PARTICULAR PURPOSE OR USE, MERCHANTABILITY, PERFORMANCE, QUALITY OR NON-INFRINGEMENT OF ANY INTELLECTUAL PROPERTY RIGHT; ALL SUCH WARRANTIES ARE HEREBY EXPRESSLY DISCLAIMED. SKYWORKS DOES NOT WARRANT THE ACCURACY OR COMPLETENESS OF THE INFORMATION, TEXT, GRAPHICS OR OTHER ITEMS CONTAINED WITHIN THESE MATERIALS. SKYWORKS SHALL NOT BE LIABLE FOR ANY DAMAGES, INCLUDING BUT NOT LIMITED TO ANY SPECIAL, INDIRECT, INCIDENTAL, STATUTORY, OR CONSEQUENTIAL DAMAGES, INCLUDING WITHOUT LIMITATION, LOST REVENUES OR LOST PROFITS THAT MAY RESULT FROM THE USE OF THE MATERIALS OR INFORMATION, WHETHER OR NOT THE RECIPIENT OF MATERIALS HAS BEEN ADVISED OF THE POSSIBILITY OF SUCH DAMAGE.

Skyworks products are not intended for use in medical, lifesaving or life-sustaining applications, or other equipment in which the failure of the Skyworks products could lead to personal injury, death, physical or environmental damage. Skyworks customers using or selling Skyworks products for use in such applications do so at their own risk and agree to fully indemnify Skyworks for any damages resulting from such improper use or sale.

Customers are responsible for their products and applications using Skyworks products, which may deviate from published specifications as a result of design defects, errors, or operation of products outside of published parameters or design specifications. Customers should include design and operating safeguards to minimize these and other risks. Skyworks assumes no liability for applications assistance, customer product design, or damage to any equipment resulting from the use of Skyworks products outside of stated published specifications or parameters.

Skyworks and the Skyworks symbol are trademarks or registered trademarks of Skyworks Solutions, Inc., in the United States and other countries. Third-party brands and names are for identification purposes only, and are the property of their respective owners. Additional information, including relevant terms and conditions, posted at www.skyworksinc.com, are incorporated by reference.