



Optical reading head PXV100S-F200-SSI-Ex

- Explosion protection for use in Zone 1, Zone 2, Zone 21 and Zone 22
- SSI interface
- Non-contact positioning on Data Matrix code tape
- Mechanically rugged: no wearing parts, long operating life, maintenance-free
- High resolution and precise positioning, especially for facilities with curves and switch points as well as inclines and declines.
- Travel ranges up to 10 km

Optical reading head for hazardous area



Dimensions

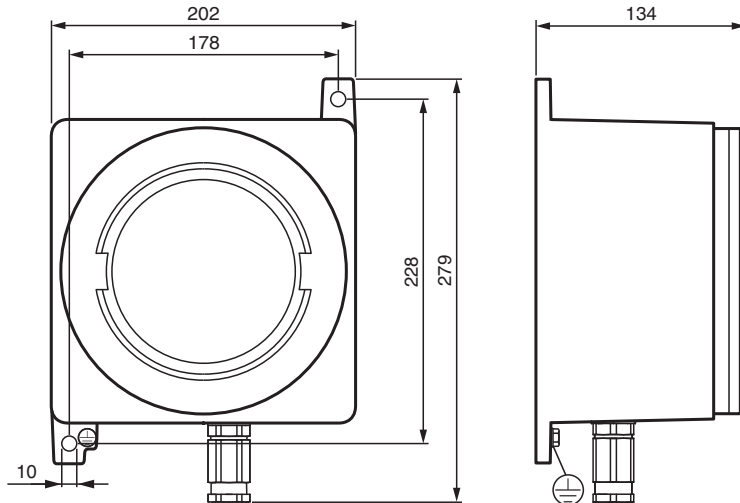

Technical Data

General specifications

Passage speed	v	≤ 8 m/s
Measuring range		max. 10000 m
Light type		Integrated LED lightning (red)
Scan rate		100 s ⁻¹
Read distance		90mm (from outer housing window)
Depth of focus		+ 20 mm / - 40 mm
Reading field		115 mm x 73 mm
Ambient light limit		100000 Lux
Accuracy		± 0.2 mm

Nominal ratings

Camera		
Type		CMOS , Global shutter
Processor		
Clock pulse frequency		600 MHz
Speed of computation		4800 MIPS

Functional safety related parameters

Release date: 2020-11-05 Date of issue: 2020-11-05 Filename: 70129724_eng.pdf

Refer to "General Notes Relating to Pepperl+Fuchs Product Information".

Pepperl+Fuchs Group
www.pepperl-fuchs.com

USA: +1 330 486 0001
fa-info@us.pepperl-fuchs.com

Germany: +49 621 776 1111
fa-info@de.pepperl-fuchs.com

Singapore: +65 6779 9091
fa-info@sg.pepperl-fuchs.com

PEPPERL+FUCHS

Technical Data

MTTF _d		87 a
Mission Time (T _M)		20 a
Diagnostic Coverage (DC)		0 %
Indicators/operating means		
LED indication		7 LEDs (communication, alignment aid, status information)
Electrical specifications		
Operating voltage	U _B	15 ... 30 V DC , PELV
No-load supply current	I ₀	max. 200 mA
Power consumption	P ₀	3 W
Interface 1		
Interface type		SSI interface
Data output code		Gray code, binary code , programmable
Monoflop time		10 μs
Clock frequency		100 ... 1000 kHz
Query cycle time		≥ 3 ms
Pause time	tp	≥ 20 μs
Double check possible		when tp ≤ 10 μs
Interface 2		
Interface type		USB Service (serial comport)
Protocol		8E1
Transfer rate		38.4 ... 460.8 kBit/s
Input		
Input type		1 to 3 functional inputs , programmable
Input impedance		≥ 27 kΩ
Output		
Output type		1 to 2 switch outputs , PNP , programmable , short-circuit protected
Switching voltage		Operating voltage
Switching current		150 mA each output
Standard conformity		
Emitted interference		EN 61000-6-4:2007+A1:2011
Noise immunity		EN 61000-6-2:2005
Approvals and certificates		
IECEX approval		IECEX INE 14.0042X
ATEX approval		INERIS 14 ATEX 0035X Device type: GUBW1.D.OS-PXV100S-F200-SSI-V1
Marking		Ⓜ II 2 GD Ex db IIC T6 Gb Ex tb IIIC T85°C Db
Ambient conditions		
Ambient temperature		0 ... 55 °C (32 ... 131 °F)
Mechanical specifications		
Connection type		Connection terminals, max. conductor cross-section 2.5 mm ²
Conductor cross section		0.13 ... 2.5 mm ²
Cable gland		3 ... 8.5 mm
Enclosure cover		threaded round cover
Cover fixing		flamepath thread
Cover seal		none, O-ring for IP66/67
Housing width		202 mm
Housing height		279 mm
Housing depth		134 mm
Degree of protection		IP66 (IP66/67 with O-ring)
Material		
Enclosure		aluminum alloy
Glass		thermo-resistant tempered glass

Release date: 2020-11-05 Date of issue: 2020-11-05 Filename: 70129724_eng.pdf

Refer to "General Notes Relating to Pepperl+Fuchs Product Information".

Pepperl+Fuchs Group
www.pepperl-fuchs.comUSA: +1 330 486 0001
fa-info@us.pepperl-fuchs.comGermany: +49 621 776 1111
fa-info@de.pepperl-fuchs.comSingapore: +65 6779 9091
fa-info@sg.pepperl-fuchs.com

PEPPERL+FUCHS

Technical Data

Finish	epoxy coated RAL 7005 (grey)
O-Ring	silicone
Mass	approx. 7 kg
Grounding	M6 external grounding points



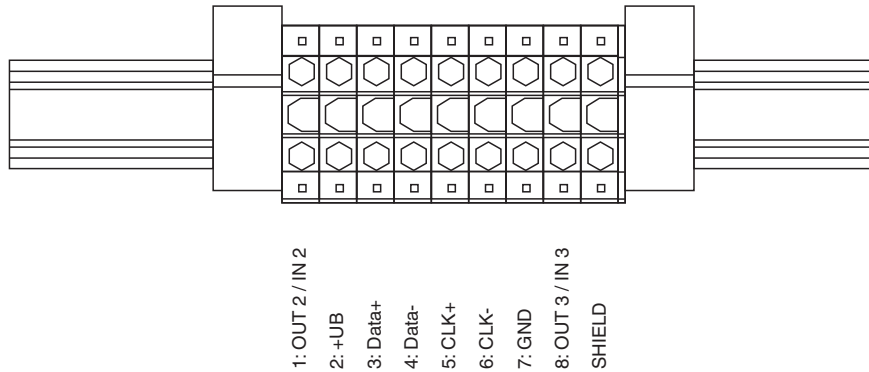



Connection Assignment



Matching System Components

	PXV*-CA25-*	Data Matrix code tape
---	--------------------	-----------------------

Accessories

	PCV-USB-RS485-Converter Set	USB to RS 485 interface converter
	PCV-KBL-V19-STR-RS485	Cable unit with power supply for USB / RS-485 interface converter
	Vision Configurator	Operating software for camera-based sensors
	V19S-G-BK5M-PUR-U/ABG	Cable connector, M12, 8-pin, PUR cable, shielded
	V19S-G-BK10M-PUR-U/ABG	Cable connector, M12, 8-pin, PUR cable, shielded
	PXV-CM25-*-*-SET	Event Marker for PXV system

Release date: 2020-11-05 Date of issue: 2020-11-05 Filename: 70129724_eng.pdf

Accessories

Other suitable accessories can be found at www.pepperl-fuchs.com

Release date: 2020-11-05 Date of issue: 2020-11-05 Filename: 70129724_eng.pdf

Refer to "General Notes Relating to Pepperl+Fuchs Product Information".

Pepperl+Fuchs Group
www.pepperl-fuchs.com

USA: +1 330 486 0001
fa-info@us.pepperl-fuchs.com

Germany: +49 621 776 1111
fa-info@de.pepperl-fuchs.com

Singapore: +65 6779 9091
fa-info@sg.pepperl-fuchs.com