

ILB IB AI4 AO2

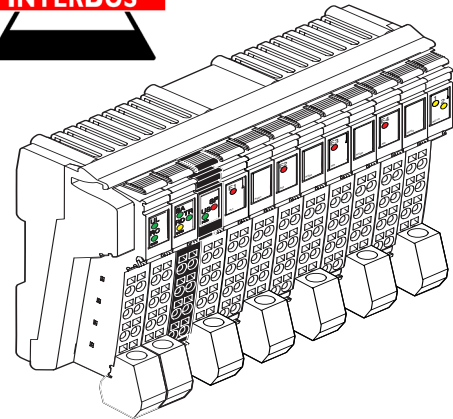

Inline Block IO Module for INTERBUS With 4 Analog Inputs and 2 Analog Outputs



AUTOMATIONWORX

Data Sheet
7280_en_02

© PHOENIX CONTACT - 02/2007

1 Description

The ILB IB AI4 AO2 module is designed for use within an INTERBUS network. It is used to acquire analog input signals and output analog signals.

Features of INTERBUS

- Remote bus branch; Inline connector
- 500 kbps transmission speed
- I/O areas can be parameterized individually for each channel
- Parameterization via process data or PCP

Features of Inputs

- 4 differential analog signal inputs or 4 universal RTD inputs
- Connection of sensors in 2, 3 or 4-wire technology
- Sensor supply with channel-specific integrated short-circuit and overload protection
- Three current measuring ranges:
0 mA to 20 mA, ± 20 mA, 4 mA to 20 mA

- Four voltage measuring ranges:
0 V to 5 V, ± 5 V, 0 V to 10 V, ± 10 V
- Various RTD measuring ranges:
E.g., linear R: 0 Ω to 9500 Ω , Pt 100, Pt 1000, Ni 1000
- Measured value representation in four possible formats
- 16-bit measured value resolution (15 bits + sign bit)
- Adjustable filter times

Features of Outputs

- 2 universal analog signal outputs to connect either voltage or current signals
- Connection of actuators in 2-wire technology
- Three current ranges:
0 mA to 20 mA, ± 20 mA, 4 mA to 20 mA
- Four voltage ranges:
0 V to 5 V, ± 5 V, 0 V to 10 V, ± 10 V
- Short-circuit-proof outputs



Please refer to the "Assembly and Removal of Inline Block IO Modules" application note (see "Ordering Data" on page 4).



Make sure you always use the latest documentation.
It can be downloaded at www.download.phoenixcontact.com.
A conversion table is available on the Internet at
www.download.phoenixcontact.com/general/7000_en_00.pdf.

Table of Contents

1	Description.....	1
2	Ordering Data.....	4
3	Technical Data.....	4
4	Internal Circuit Diagram.....	12
5	Electrical Isolation.....	13
6	Local Diagnostic and Status Indicators	13
7	Connection of INTERBUS, Supply, Analog Sensors, and Actuators.....	14
	7.1 Terminal Point Assignment of the INTERBUS Connectors.....	15
	7.2 Terminal Point Assignment of the Power Connector	15
	7.3 Terminal Point Assignment of the Connectors for the Analog Inputs.....	15
	7.4 Terminal Point Assignment of the Connectors for the Analog RTD Inputs	16
	7.5 Terminal Point Assignment of the Connectors for the Analog Outputs.....	16
8	Connection Notes	17
9	Connection Examples.....	17
	9.1 Connection Examples for Analog Inputs	18
	9.2 Connection Examples for RTD Inputs.....	19
	9.3 Connection Examples for Analog Outputs	19
10	Programming Data	20
11	Process Data	20
	11.1 Assignment of the Process Data to the Terminal Points for the "Read and Write Analog Values" Command.....	21
12	OUT Process Data Words	22
13	IN Process Data Words	23
	13.1 Input Word IN1 (Status Word).....	23
	13.2 Input Words IN2 to IN5.....	23
14	Formats for the Representation of Measured Values (IN2 to IN5)	24
	14.1 Format: "IB IL" (Default Setting).....	24
	14.2 Format: "RT"	26
	14.3 Format: "S7-Compatible"	27
	14.4 Format: "Standardized Representation".....	29
15	Configuration	31
16	Configuration via Process Data	31
	16.1 Output Word OUT1 (Control Word) for Command Code 40xx _{hex} (Configure Device).....	31
	16.2 Output Words OUT2 to OUT5 (Configuration).....	32
	16.3 Example for the Module Configuration via Process Data.....	33
17	Configuration via PCP	34
18	PCP Communication	35
	18.1 Object Dictionary.....	35
	18.2 Object Description.....	36
19	Diagnostics	38

20	Channel Conversion Times and Process Data Update Time	39
21	Behavior of the Analog Outputs in the Event of INTERBUS Reset and Power Up	40
22	Notes on Systematic and Random Errors During Resistance and Temperature Measurement...	
	40	
22.1	Measures to Optimize Tolerances	40
22.2	Connection Method	41
22.3	RTD 3-Wire Connection	41
22.4	Systematic Errors During Temperature Measurement With 2-Wire Technology	42

2 Ordering Data

Module

Description	Type	Order No.	Pcs./Pck.
Inline Block IO module for INTERBUS with 4 analog inputs and 2 analog outputs	ILB IB AI4 AO2	2878777	1

Accessories: Connectors as Replacement Item

Description	Type	Order No.	Pcs./Pck.
Shield connector for the bus connection (with color print)	IB IL SCN-6 SHIELD-CP	2863151	5
Connector for the supply (with color print)	On request		
Shield connector for the connection of analog sensors (without color print)	IB IL SCN-6 SHIELD	2726353	5
Shield connector for the connection of analog actuators (without color print)	IB IL SCN 6-SHIELD-TWIN	2740245	5
Connector (without color print)	IB IL SCN-8	2726337	10

Accessories: Other

Description	Type	Order No.	Pcs./Pck.
Recommended end clamp; placed both to the right and left of the module to secure it on the DIN rail	CLIPFIX 35-5	3022276	50

Documentation

Description	Type	Order No.	Pcs./Pck.
"Assembly and Removal of Inline Block IO Modules" application note	AH ILB INSTALLATION	9014931	1
"General Introduction to the INTERBUS System" user manual	IBS SYS INTRO G4 UM E	2745211	1
"Peripherals Communication Protocol (PCP)" user manual	IBS SYS PCP G4 UM E	2745169	1
"Porting Using PCP Compact" user manual	IBS PCP COMPACT UM E	9015349	1

3 Technical Data

General Data

Housing dimensions with connectors (width x height x depth)	156 mm x 59 mm x 141 mm
Weight	505 g (with connectors)
Operating mode	INTERBUS
Transmission speed	500 kbps
Connection method for sensors	2, 3, and 4-wire technology (shielded)
Connection method for actuators	2-wire technology (shielded)

Housing Dimensions

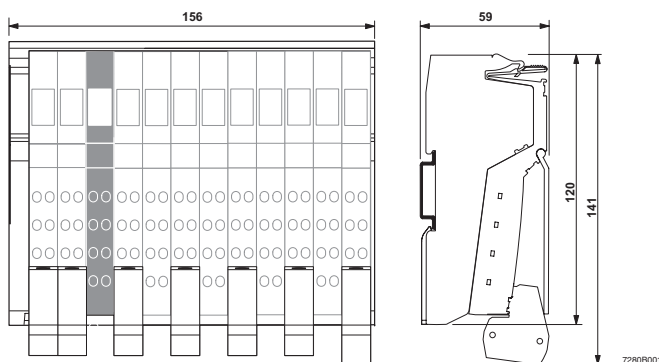

Figure 1 Module housing dimensions (in mm)

Ambient Conditions

Guidelines	Developed according to VDE 0160/EN 50178/IEC 62103, UL 508
Ambient temperature (operation)	-25°C to +60°C
Ambient temperature (storage/transport)	-25°C to +85°C
Humidity (operation/storage/transport)	10% to 95%, according to DIN EN 61131-2
Air pressure (operation)	80 kPa to 108 kPa (up to 2000 m above sea level)
Air pressure (storage/transport)	66 kPa to 108 kPa (up to 3500 m above sea level)
Degree of protection according to DIN 40050, IEC 60529	IP20
Protection class according to DIN 57106-1	Class 3 according to VDE 0106/IEC 60536
Air and creepage distances	According to DIN VDE 0110/IEC 60664, IEC 60664A, DIN VDE 0160/EN 50178/IEC 62103
Housing material	Plastic, PVC-free, PBT, self-extinguishing (V0)
Pollution degree according to EN 60664-1/IEC 60664-1, EN 61131-2/IEC 61131-2	2; condensation not permitted during operation
Surge voltage class	II

Electrical Isolation/Isolation of the Voltage Areas

Test Distance	Test Voltage
Incoming remote bus/logic area, outgoing remote bus	500 V AC, 50 Hz, 1 min.
Incoming remote bus/analog I/O	500 V AC, 50 Hz, 1 min.
Incoming remote bus/communications power U_L (primary)	500 V AC, 50 Hz, 1 min.
Incoming remote bus/initiator supply U_{IS}	500 V AC, 50 Hz, 1 min.
Incoming remote bus/functional earth ground	500 V AC, 50 Hz, 1 min.
Logic area, outgoing remote bus/analog I/O	500 V AC, 50 Hz, 1 min.
Logic area, outgoing remote bus/communications power U_L (primary)	500 V AC, 50 Hz, 1 min.
Logic area, outgoing remote bus/initiator supply U_{IS}	500 V AC, 50 Hz, 1 min.
Logic area, outgoing remote bus/functional earth ground	500 V AC, 50 Hz, 1 min.
Analog I/O/communications power U_L (primary)	500 V AC, 50 Hz, 1 min.
Analog I/O/initiator supply U_{IS}	500 V AC, 50 Hz, 1 min.
Analog I/O/functional earth ground	500 V AC, 50 Hz, 1 min.
Communications power U_L (primary)/initiator supply U_{IS}	500 V AC, 50 Hz, 1 min.
Communications power U_L (primary)/functional earth ground	500 V AC, 50 Hz, 1 min.
Initiator supply U_{IS} /functional earth ground	500 V AC, 50 Hz, 1 min.
Outgoing remote bus/analog I/O	500 V AC, 50 Hz, 1 min.
Outgoing remote bus/functional earth ground	500 V AC, 50 Hz, 1 min.

Mechanical Requirements

Vibration test sinusoidal vibrations according to EN 60068-2-6/IEC 60068-2-6	5g load, 2.5 hours in each space direction
Shock test according to EN 60068-2-27/IEC 60068-2-27	30g load for 11 ms, half sinusoidal wave, 3 shocks in each space direction and orientation
Broadband noise according to EN 60068-2-64/IEC 60068-2-64	0.78g load, 2.5 hours in each space direction

Conformance With EMC Directive 89/336/EEC

Noise Immunity Test According to EN 61000-6-2

Electrostatic discharge (ESD)	EN 61000-4-2 IEC 61000-4-2	Criterion B 6 kV contact discharge 8 kV air discharge
Electromagnetic fields	EN 61000-4-3 IEC 61000-4-3	Criterion A Field strength: 10 V/m
Fast transients (burst)	EN 61000-4-4/ IEC 61000-4-4	Criterion B Remote bus: 2 kV Power supply: 2 kV I/O cables: 2 kV Criterion A All interfaces: 1 kV
Surge voltage	EN 61000-4-5 IEC 61000-4-5	Criterion B DC supply lines: ± 0.5 kV/ ± 0.5 kV (symmetrical/asymmetrical) Signal lines: ± 0.5 kV/ ± 0.5 kV (symmetrical/asymmetrical)
Conducted interference	EN 61000-4-6 IEC 61000-4-6	Criterion A Test voltage 10 V

Noise Emission Test According to EN 61000-6-4

Noise emission of housing	EN 55011	Class A
---------------------------	----------	---------

Interface: INTERBUS

Incoming remote bus	Copper cable (RS-422), connected with Inline shield connector; supply electrically isolated; shielding connected with a capacitor to functional earth ground
Outgoing remote bus	Copper cable (RS-422), connected with Inline shield connector; supply electrically isolated; shielding connected directly to functional earth ground
Recommended cable lengths	See INTERBUS system data in the IBS SYS INTRO G4 UM E user manual

24 V Module Supply (Communications Power and Sensor Supply; U_L and U_S)

Nominal value	24 V DC
Tolerance	-15%/+20% according to EN 61131-2
Ripple	$\pm 5\%$ according to EN 61131-2
Permissible range	19.2 V DC to 30.0 V DC
Current consumption at U_L	See "Current Consumption at U_L and U_S "
Current consumption at U_S	See "Current Consumption at U_L and U_S "
Power dissipation at U_L	See "Power Consumption at U_L and U_S " on page 7
Power dissipation at U_S	See "Power Consumption at U_L and U_S " on page 7
Safety equipment for U_L	Transient surge protection via arresters, serial protection against polarity reversal
Safety equipment for U_S	Transient surge protection via arresters, serial protection against polarity reversal, channel-specific short-circuit protection with single-channel diagnostics
Connection	Via power connectors
Diagnostics	Single-channel diagnostics in the process data Failure indication via group error LED at PWR slot Single-channel failure indication via LED at slot for the sensors

Electronically Protected Initiator Supply U_{IS} (via Supply of U_S)

Nominal value U_{IS}	24 V DC
Nominal current I_{IS} per channel	50 mA
Protection	Internal, channel-specific electronic fuse, short-circuit-proof with single-channel diagnostics

Current Consumption at U_L and U_S	Typical	Maximum
Current consumption at U_L		
No-load operation of outputs and AI mode	100 mA	130 mA
RTD nominal load	100 mA	130 mA
AO U nominal load (U_{OUT1} and $U_{OUT2} = 10$ V with $R_L = 2$ k Ω)	110 mA	140 mA
AO I nominal load (I_{OUT1} and $I_{OUT2} = 20$ mA with $R_L = 0$ Ω)	135 mA	175 mA
Current consumption at U_S		
$I_S = 0$ mA (no load)	12 mA	20 mA
$I_S = 4 \times 20$ mA (nominal load)	92 mA	100 mA
$I_S = 4 \times 50$ mA (maximum full load)	212 mA	220 mA
Total current consumption at U_L and U_S		
No-load operation of outputs and AI mode; $I_S = 0$ mA (no load)	112 mA	150 mA
AO U nominal load and AI nominal load; $I_S = 4 \times 20$ mA	202 mA	240 mA
AO I nominal load and AI nominal load; $I_S = 4 \times 20$ mA	227 mA	275 mA
AO I nominal load and AI full load; $I_S = 4 \times 50$ mA	347 mA	395 mA

Power Consumption at U_L and U_S
(Current Consumption at Voltages U_L and U_S ;
Specifications for Nominal Operation ($U_L = 24$ V; $U_S = 24$ V Without Load), Full Load Same as Nominal Operation
But With U_S Under Load)

Typical Supply of Control Cabinet Power Supply Unit P_{24V_Supply}	AO Load	Marginal Conditions	Typical Supply Current	Typical Power Dissipation
Typical power supply P_{24V_Supply} in U nominal operation	U mode of the analog outputs ($U_{OUT1,2} = 10$ V with $R_L = 10$ K)	$I_S = 0$ mA	125 mA	3.00 W
Typical power supply P_{24V_Supply} in I nominal operation	I mode of the analog outputs ($I_{OUT1,2} = 20$ mA, with $R_b = 0$ Ω)	$I_S = 0$ mA	150 mA	3.60 W
Typical power supply P_{24V_Supply} in nominal operation	U mode of the analog outputs ($U_{OUT1,2} = 10$ V with $R_L = 10$ K)	$I_S = 4 \times 20$ mA	200 mA	4.80 W
Typical power supply P_{24V_Supply} at full load	I mode of the analog outputs ($I_{OUT1,2} = 20$ mA, with $R_b = 0$ Ω)	$I_S = 4 \times 20$ mA	230 mA	5.45 W
Typical power supply P_{24V_Supply} in nominal operation	U mode of the analog outputs ($U_{OUT1,2} = +10$ V with $R_L = 10$ K)	$I_S = 4 \times 50$ mA	325 mA	7.75 W
Typical power supply P_{24V_Supply} at full load	I mode of the analog outputs ($I_{OUT1,2} = 20$ mA, with $R_b = 0$ Ω)	$I_S = 4 \times 50$ mA	350 mA	8.35 W

Analog Inputs

Number	4 differential analog inputs
Measured value resolution	16 bits (15 bits + sign bit)
Measured value representation	In the following formats: IB IL (15 bits with sign bit) RT (15 bits with sign bit) S7-compatible (15 bits with sign bit) Standardized representation (15 bits with sign bit)



For measured value representation, please refer to the notes on page 24 and onwards.

Filtering	RFI filtering; passive TP 1st order
Filter time of the A/D converter	4.5 ms (default) or 1.1 ms; adjustable for each channel
Conversion time of the A/D converter	180 μ s
Channel conversion times and process data update time	See "Channel Conversion Times and Process Data Update Time" on page 39
Limit frequency (-3 dB) of the input filters	120 Hz (for 4.5 ms filter default) or 450 Hz (for 1.1 ms filter)
Transient protection	Yes, via arresters
Signal connection method	2, 3, and 4-wire connection; shielded, twisted pair cable
Overload protection	Yes, ± 30 V DC, minimum

Differential Analog Voltage Inputs

Number	4
Input range	0 V to 10 V; ±10 V; 0 V to 5 V; ±5 V
Input resistance	276 kΩ, typical
Open circuit response	Goes to 0 V
Maximum permissible voltage between analog voltage inputs and functional earth ground	±50 V DC

Differential Analog Current Inputs

Number	4
Input range	0 mA to 20 mA; ±20 mA; 4 mA to 20 mA
Input resistance	107 Ω, typical
Open circuit response	Goes to 0 mA
Maximum permissible current per current input	Electronic overload protection
Overload protection at the analog current inputs	Yes, ±30 V DC, minimum

Analog RTD Inputs

Number	4
Input range	Pt 100, Pt 500, Pt 1000, Ni 100, Ni 1000, Ni 1000 L&S, 0 Ω to 3200 Ω, 0 Ω to 9500 Ω
Sensor supply current	231 mA, typical

Analog Outputs

Number	2
Voltage output range	0 V to 10 V; ±10 V; 0 V to 5 V; ±5 V
Current output range	0 mA to 20 mA; ±20 mA; 4 mA to 20 mA
Measured value resolution	16 bits (15 bits + sign bit)
Measured value representation	In the following formats: IB IL (15 bits with sign bit) RT (15 bits with sign bit) S7-compatible (15 bits with sign bit) Standardized representation (15 bits with sign bit)



For measured value representation, please refer to the notes on page 24 and onwards.

Conversion time of the D/A converters	70 μs, typical
Resolution of the D/A converters	16 bits
Process data update time	See "Channel Conversion Times and Process Data Update Time" on page 39
Output load	
Voltage output	R _{Lmin} = 2 kΩ
Current output	R _{LB} = 0 Ω to 500 Ω
Transient protection	Yes, internally via arresters
Signal connection method	2-wire termination; shielded, twisted pair cable
Short-circuit protection	
Voltage output	Yes, permanent electronic short-circuit protection
Current output	Yes, permanent electronic short-circuit protection
Enabling function	Yes, internal electronic
Optical indicators	5% output LED, channel-specific

Permissible Cable Lengths

Permissible cable lengths	250 m
Reference conditions	The specifications refer to nominal operation observing the installation instructions. The specifications refer to the following reference cable type: Shielded power station cable: LiYCY; 2 x 2 x 0.5 mm ² ; VDE0812



The ambient conditions and the local conditions in the system can result in special requirements for the installation of cables. These must be observed accordingly.
For the integration of shielded I/O cables in an equipotential bonding concept for the automation system, the following applies in principle: Shielded analog I/O cables may only be connected directly to functional earth ground potential at a single point. This results in the prevention of voltage equalization currents via the analog cable. Additional information is available on request.
Other:
In order to observe the tolerance of RTD inputs, make allowance for the effects of the connecting cable and connection method (2, 3, and 4-wire technology).

Limit Values for Temperature Measurement

Sensor Type	Nominal Range	
	Lower Limit	Upper Limit
Pt DIN	-200°C	+850°C
Ni DIN	-60°C	+180°C
Ni 1000 L&S	-50°C	+160°C



In the event of underrange or overrange of the nominal range, the "Underrange" or "Overrange" error message is generated.

Tolerances at T_A = 25°C

AI Measuring Range	Absolute (Typical)	Absolute (Maximum)	Relative (Typical)	Relative (Maximum)
0 V to 5 V, ±5 V	±5.0 mV	±20 mV	0.10%	±0.40%
0 V to 10 V, ±10 V	±6.0 mV	±25 mV	0.06%	±0.25%
0 mA to 20 mA, ±20 mA, 4 mA to 20 mA	±12 µA	±50 µA	0.06%	±0.25%
Pt 100 (-200°C ... +850°C)	±0.3 K	±1.6 K	0.03%	±0.19%
Pt 500 (-200°C ... +850°C)	±0.2 K	±1.4 K	0.02%	±0.17%
Pt 1000 (-200°C ... +850°C)	±0.2 K	±1.3 K	0.02%	±0.15%
Ni 100 (-60°C ... +180°C)	±0.2 K	±0.9 K	0.11%	±0.50%
Ni 1000 (-60°C ... +180°C)	±0.1 K	±0.5 K	0.08%	±0.28%
Ni 1000 L&S (-50°C ... +160°C)	±0.1 K	±0.3 K	±0.02%	±1.6%
0 Ω to 3200 Ω	±0.4 Ω	±2.75 Ω	0.01%	±0.18%
0 Ω to 9500 Ω	±2.0 Ω	±12.0 Ω	0.02%	±0.13%

AO Output Range	Absolute (Typical)	Absolute (Maximum)	Relative (Typical)	Relative (Maximum)
0 V to 5 V, ±5 V	±10 mV	±30 mV	0.20%	±0.60%
0 V to 10 V, ±10 V	±10 mV	±30 mV	0.10%	±0.30%
0 mA to 20 mA, ±20 mA, 4 mA to 20 mA	±20 µA	±60 µA	0.10%	±0.30%



The data contains the offset error, gain error, and linearity error. All percentage tolerance values refer to the relevant measuring range final value. Unless otherwise stated, nominal operation (nominal voltage U_S = U_L = 24 V, preferred mounting position, default format "IB IL", default filter setting (4.5 ms), identical measuring range setting for channels, etc.) is used as the basis. For RTD inputs, the tolerances are specified in 4-wire connection method, the installation instructions should be implemented accordingly. Please also observe the values for temperature drift and the tolerances influenced by electromagnetic interference. The maximum tolerance values represent the worst-case measurement inaccuracy. They contain the theoretical maximum possible tolerances in the measuring ranges. Moreover, the theoretical maximum possible tolerances of the calibration and test equipment have been taken into consideration.

Tolerance and Temperature Response at T_A = -25°C to +60°C

AI Measuring Range	Drift (Typical)	Drift (Maximum)
0 V to 5 V, ±5 V	±15 ppm/K	±35 ppm/K
0 V to 10 V, ±10 V	±15 ppm/K	±35 ppm/K
0 mA to 20 mA, ±20 mA, 4 mA to 20 mA	±20 ppm/K	±50 ppm/K
Pt 100 (-200°C ... +850°C)	±40 ppm/K	±100 ppm/K
Pt 500 (-200°C ... +850°C)	±35 ppm/K	±90 ppm/K
Pt 1000 (-200°C ... +850°C)	±30 ppm/K	±80 ppm/K
Ni 100 (-60°C ... +180°C)	±60 ppm/K	±110 ppm/K
Ni 1000 L&S (-50°C ... +180°C)	±20 ppm/K	±50 ppm/K
Ni 1000 (-60°C ... +180°C)	±20 ppm/K	±50 ppm/K
0 Ω to 3200 Ω	±20 ppm/K	±60 ppm/K
0 Ω to 9500 Ω	±25 ppm/K	±50 ppm/K
AO Output Range	Drift (Typical)	Drift (Maximum)
0 V to 5 V, ±5 V, 0 V to 10 V, ±10 V	±55 ppm/K	±95 ppm/K
0 mA to 20 mA, ±20 mA, 4 mA to 20 mA	±50 ppm/K	±90 ppm/K



The values refer to the relevant measuring range final value.
 The values refer to nominal operation in the recommended mounting position (horizontal wall mounting).

Formula for Calculating the Tolerance Influenced by Temperature

Typical temperature drift

$$\text{Drift}_{\text{typ}} = \Delta\vartheta \times T_{\text{Ctyp}} \times \text{MFV}$$

Where:

- Drift_{typ} Typical temperature drift
- Δϑ Temperature difference between the ambient temperature of the module T_A and +25°C
- T_{Ctyp} Typical temperature coefficient in ppm/K
- MFV Measuring range final value (e.g., +850°C for Pt 100)

Maximum temperature drift

$$\text{Drift}_{\text{max}} = \Delta\vartheta \times T_{\text{Cmax}} \times \text{MFV}$$

Where:

- Drift_{max} Maximum temperature drift
- Δϑ Temperature difference between the ambient temperature of the module T_A and +25°C
- T_{Cmax} Maximum temperature coefficient in ppm/K
- MFV Measuring range final value (e.g., +850°C for Pt 100)

Example

Sensor = Pt 100; ambient temperature T_A = +40°C
 Δϑ = +15 K
 T_{Ctyp} = ±40 ppm/K (typical); T_{Cmax} = ±100 ppm/K
 Measuring range final value Pt 100 MFV = +850°C
 Drift_{typ} = Δϑ x T_{Ctyp} x MFV = 15 K x ±40 ppm/K x 850°C = ±0.51°C
 Drift_{max} = Δϑ x T_{Cmax} x MFV = 15 K x ±100 ppm/K x 850°C = ±1.28°C
 The maximum drift is a worst-case value (theoretical assumption).

Tolerances Influenced by Electromagnetic Interference						
		Analog Input			Analog Output	
		Current	Voltage	RTD	Current	Voltage
Electromagnetic fields	EN 61000-4-3 IEC 61000-4-3	< ±1.5%	< 0.2 %	< ±2.0%	< ±0.5%	< ±0.5%
Fast transients (burst)	EN 61000-4-4/ IEC 61000-4-4	< ±1.5%	< 0.2 %	< ±2.0%	< ±0.5%	< ±0.5%
Conducted interference	EN 61000-4-6 IEC 61000-4-6	< ±1.5%	< 0.2 %	< ±2.0%	< ±0.5%	< ±0.5%



Under the influence of high-frequency electromagnetic interference phenomena caused by radio transmission systems in close proximity, additional tolerances can occur. The values specified refer to nominal operation in the event of direct interference to components without additional shielding such as a steel cabinet, etc.

This information is valid for device firmware ID HW/FW 04/100 or later.

The tolerances specified above can be reduced through additional shielding for the I/O module (e.g., use of a shielded control box/control cabinet, etc.). Please refer to the recommended measures in the Inline system manual for your bus system.

Signal Rise Times: Voltage Output 0 V to 10 V (Typical Values)

	10% to 90%	0% to > 99%
Ohmic load $R_L = 2\text{ k}\Omega$	160 μs	240 μs
Ohmic/capacitive load $R_L = 2\text{ k}\Omega/C_L = 10\text{ nF}$	160 μs	240 μs
Ohmic/capacitive load $R_L = 2\text{ k}\Omega/C_L = 220\text{ nF}$	170 μs	240 μs
Ohmic/inductive load $R_L = 2\text{ k}\Omega/L_L = 3.3\text{ mH}$	170 μs	240 μs

Signal Rise Times: Current Output 0 mA to 20 mA (Typical Values)

	10% to 90%	0% to > 99%
Ohmic load $R_L = 500\ \Omega$	450 μs	730 μs
Ohmic/capacitive load $R_L = 500\ \Omega/C_L = 10\text{ nF}$	460 μs	750 μs
Ohmic/capacitive load $R_L = 500\ \Omega/C_L = 220\text{ nF}$	770 μs	1.3 ms
Ohmic/inductive load $R_L = 500\ \Omega/L_L = 3.3\text{ mH}$	610 μs	1.1 ms
Ohmic/capacitive load $R_L = 50\ \Omega/C_L = 100\text{ nF}$	11 ms	20.7 ms

Signal Rise Times: Current Output 4 mA to 20 mA (Typical Values)

	10% to 90%	0% to > 99%
Ohmic load $R_L = 500\ \Omega$	400 μs	810 μs
Ohmic/capacitive load $R_L = 500\ \Omega/C_L = 10\text{ nF}$	470 μs	840 μs
Ohmic/capacitive load $R_L = 500\ \Omega/C_L = 220\text{ nF}$	800 μs	1.4 ms
Ohmic/inductive load $R_L = 500\ \Omega/L_L = 3.3\text{ mH}$	590 μs	990 μs

Approvals

For the latest approvals, please visit www.download.phoenixcontact.com.

4 Internal Circuit Diagram

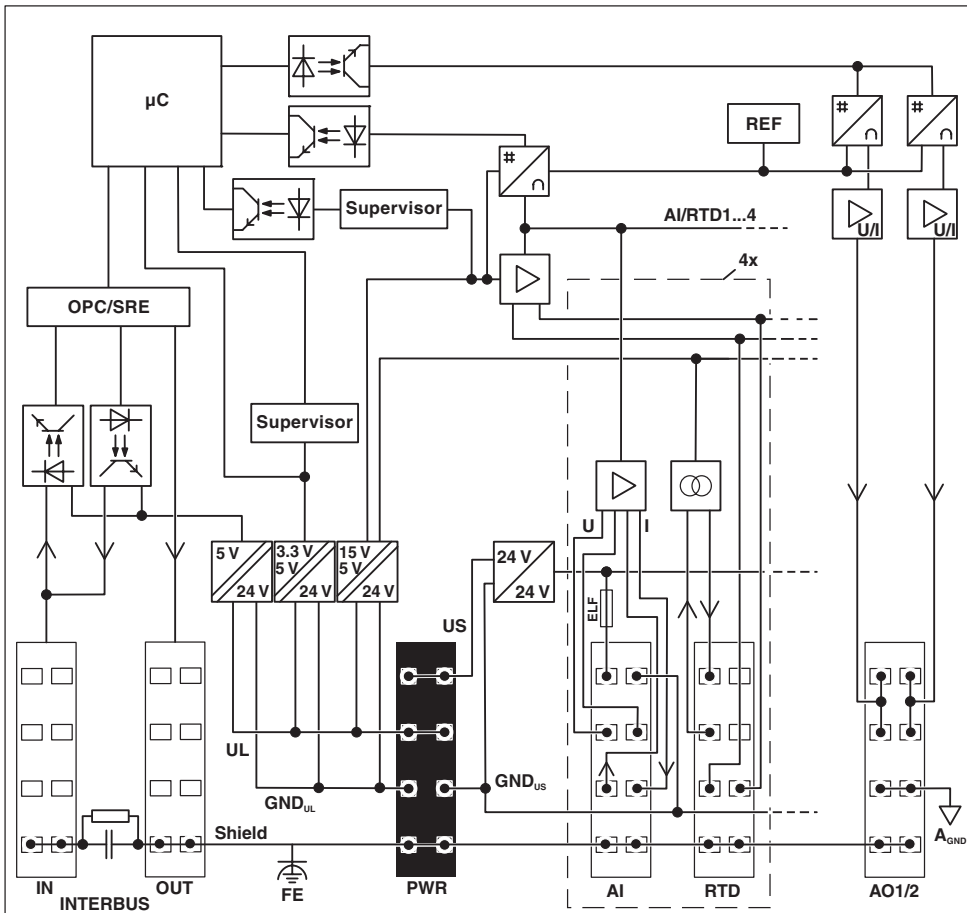

7280A020

Figure 2 Internal wiring of the terminal points

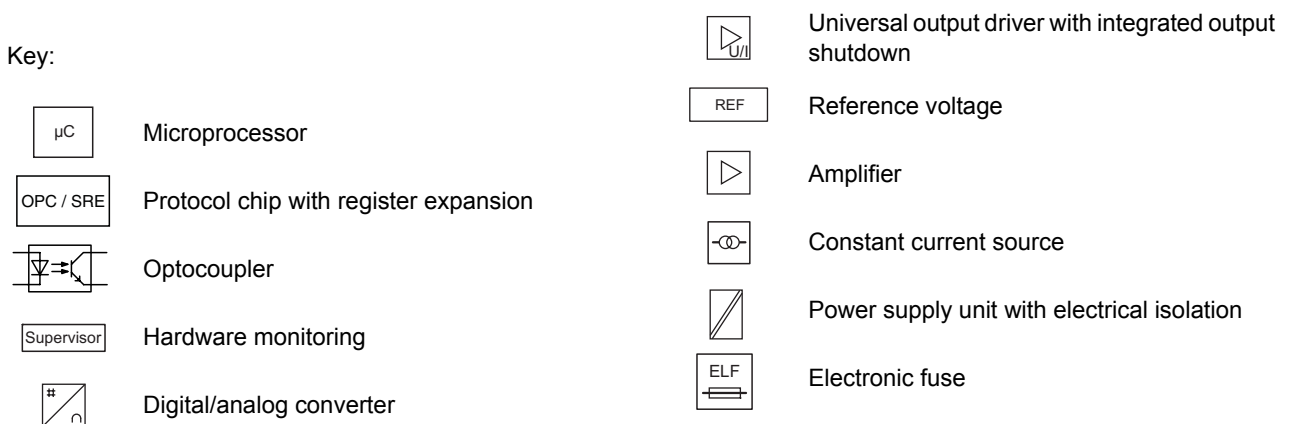

5 Electrical Isolation

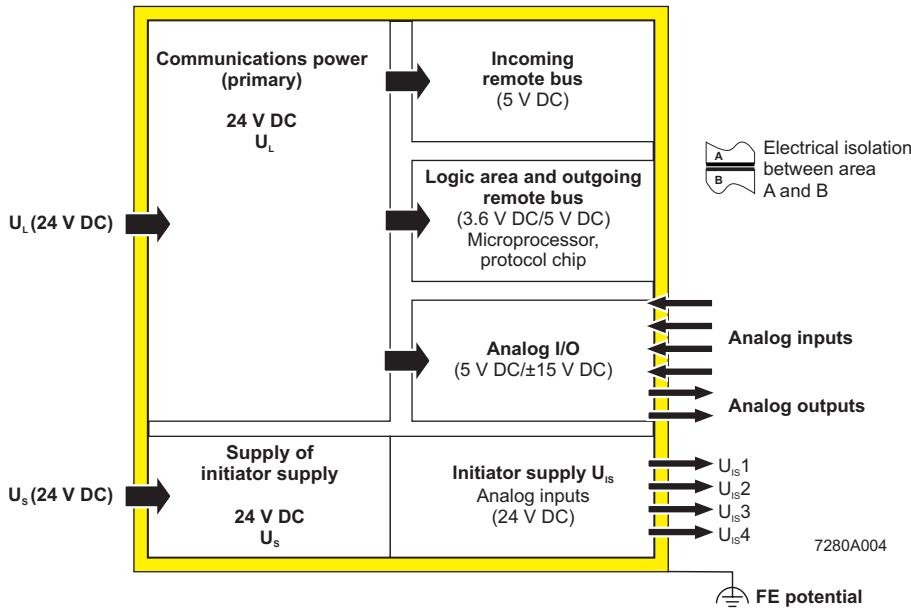
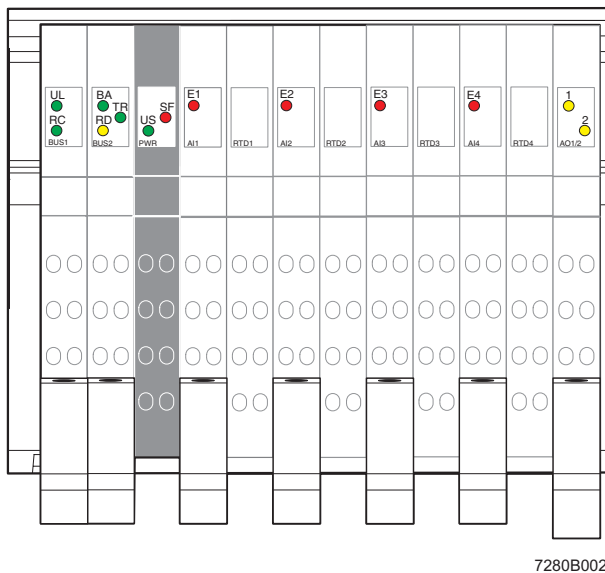

Figure 3 Electrical isolation of the individual function areas

6 Local Diagnostic and Status Indicators



Designation	Color	Meaning
BUS		
UL	Green	Communications power
RC	Green	Remote bus cable check
BA	Green	Bus active
RD	Yellow	Outgoing remote bus disabled
TR	Green	PCP communication active
PWR		
US	Green	Sensor supply
SF	Red	Group error
AI		
E1 to E4	Red	Channel-specific error indication (sensor supply short circuit or open circuit)
AO		
1, 2	Yellow	Analog output value is $\geq 5\%$ of the positive measuring range final value

Figure 4 Diagnostic and status indicators

7 Connection of INTERBUS, Supply, Analog Sensors, and Actuators

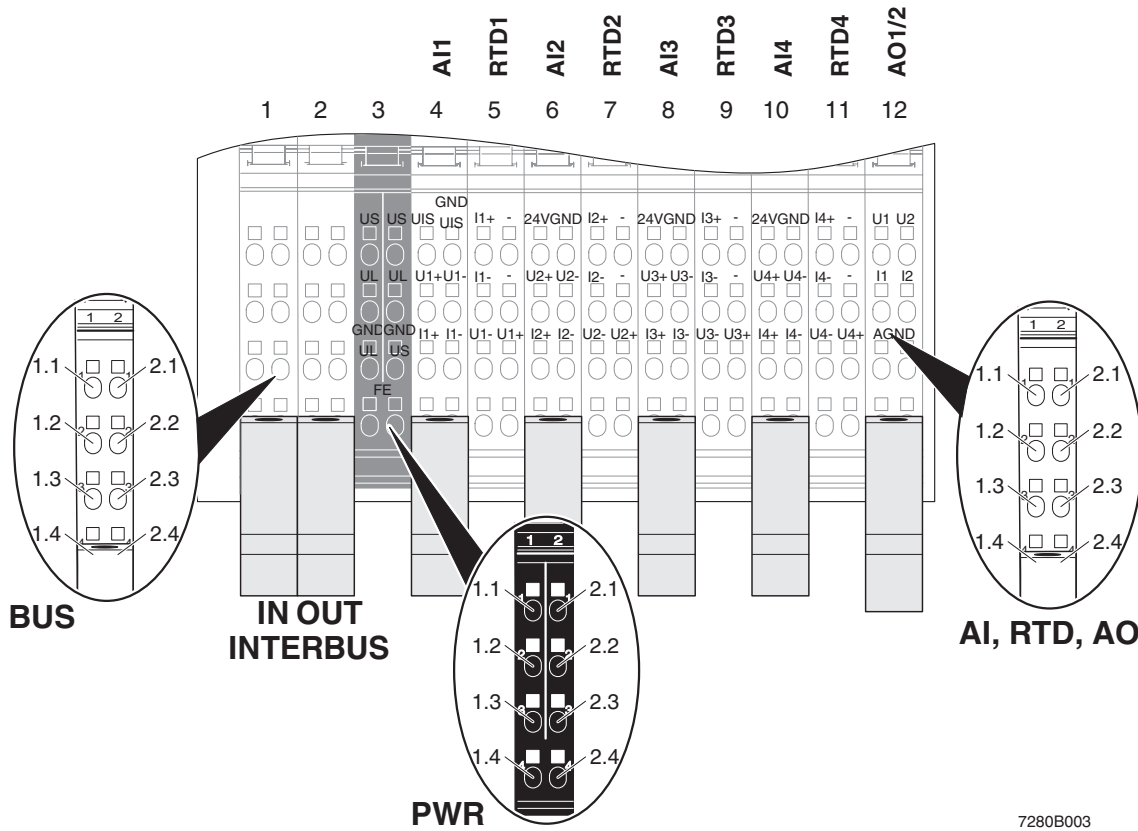

7280B003

Figure 5 Terminal point assignment of the connectors

7.1 Terminal Point Assignment of the INTERBUS Connectors

Terminal Point	Assignment	Remark/Wire Color in the INTERBUS Standard Cable	
Connector 1 (BUS 1) Incoming Remote Bus			
1.1	DO1	Receive	Green
2.1	DO1	Receive	Yellow
1.2	DI1	Transmit	Pink
2.2	DI1	Transmit	Gray
1.3	F-GND	Reference potential	Brown
2.3			Not used
1.4, 2.4	Shield	Shield potential is connected with a capacitor to functional earth ground (FE) of the potential jumper.	
Connector 2 (BUS 2) Outgoing Remote Bus			
1.1	DO2	Transmit	Green
2.1	DO2	Transmit	Yellow
1.2	DI2	Receive	Pink
2.2	DI2	Receive	Gray
1.3	R-GND	Reference potential	Brown
2.3			Not used
1.4, 2.4	Shield	Shield potential is connected directly to functional earth ground (FE) of the potential jumper.	

7.2 Terminal Point Assignment of the Power Connector

Terminal Point	Assignment
Connector 3 (PWR)	
1.1, 2.1	24 V supply U_S
1.2, 2.2	24 V communications power U_L
1.3,	GND U_L
2.3	GND U_S
1.2, 2.4	FE

7.3 Terminal Point Assignment of the Connectors for the Analog Inputs

(AI; connectors 4, 6, 8, and 10 in Figure 5 on page 14)

Terminal Point				Signal	Assignment
Connector 4 (AI1)	Connector 6 (AI2)	Connector 8 (AI3)	Connector 10 (AI4)		
1.1	1.1	1.1	1.1	U_{ISx} (24 V)	Initiator supply for channel x
2.1	2.1	2.1	2.1	GND_{ISx}	Ground of U_{ISx}
1.2	1.2	1.2	1.2	U_{x+}	Positive voltage input for channel x
2.2	2.2	2.2	2.2	U_{x-}	Negative voltage input for channel x
1.3	1.3	1.3	1.3	I_{x+}	Positive current input for channel x
2.3	2.3	2.3	2.3	I_{x-}	Negative current input for channel x
1.4, 2.4	1.4, 2.4	1.4, 2.4	1.4, 2.4	Shield	Shield connection

x = 1 to 4

7.4 Terminal Point Assignment of the Connectors for the Analog RTD Inputs

(RTD; connectors 5, 7, 9, and 11 in Figure 5 on page 14)

Terminal Point				Signal	Assignment
Connector 5 (RTD1)	Connector 7 (RTD2)	Connector 9 (RTD3)	Connector 11 (RTD4)		
1.1	1.1	1.1	1.1	Ix+	Positive constant current supply for RTD sensor channel x
2.1	2.1	2.1	2.1	–	Reserved
1.2	1.2	1.2	1.2	Ix-	Negative constant current supply for RTD sensor channel x
2.2	2.2	2.2	2.2	–	Reserved
1.3	1.3	1.3	1.3	Ux-	Negative voltage input for RTD sensor channel x
2.3	2.3	2.3	2.3	Ux+	Positive voltage input for RTD sensor channel x
1.4, 2.4	1.4, 2.4	1.4, 2.4	1.4, 2.4	Shield	Shield connection

x = 1 to 4

7.5 Terminal Point Assignment of the Connectors for the Analog Outputs

(AO, connector 12 in Figure 5 on page 14)

Terminal Point	Signal	Assignment
Connector 12 (AO)		
1.1	U1/I1	Voltage or current output channel 1
2.1	U2/I2	Voltage or current output channel 2
1.2	U1/I1	Voltage or current output channel 1
2.2	U2/I2	Voltage or current output channel 2
1.3	AGND	Analog ground channel 1
2.3	AGND	Analog ground channel 2
1.4, 2.4	Shield	Shield connection



The relevant unused terminal point for voltage or current output of a channel can be used for test purposes.

8 Connection Notes



Always connect the analog sensors using shielded, twisted pair cables.

Connect the shielding to the module using the shield connection clamp. The clamp connects the shield to FE on the module side. Avoid connection to FE from both sides.



The module is supplied with a shield connector and a standard connector for each input channel. The shield connection can be used for the standard signal (current/voltage) as well as for the RTD signal.



The module has an FE spring (metal clip) on the bottom of the electronics base. This spring establishes an electrical connection to the DIN rail. Use grounding terminals to connect the DIN rail to protective earth ground. The module is grounded when it is snapped onto the DIN rail.

To ensure reliable functional earth grounding of the module even when the DIN rail is dirty or the metal clip is damaged, always ground the module via the FE terminal point (see Figure 6).

9 Connection Examples

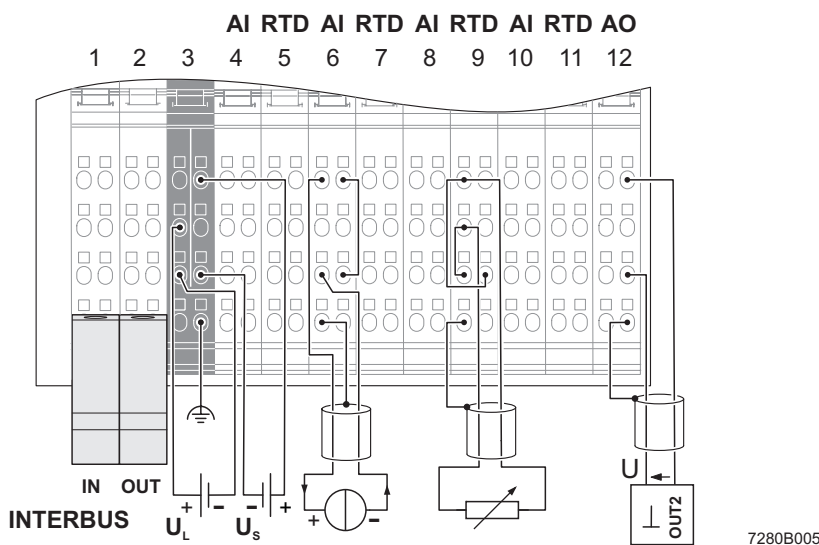

Figure 6 General connection example



Ideal current source
Application: Passive 2-wire transmitter



Variable resistor



General actuator



The numbers above the module illustration indicate the connector slots.

9.1 Connection Examples for Analog Inputs

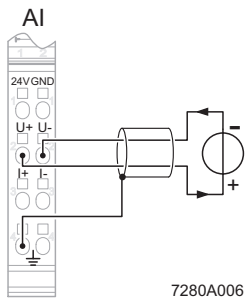
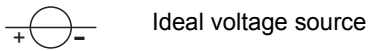
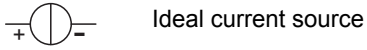

Figure 7 Voltage measurement

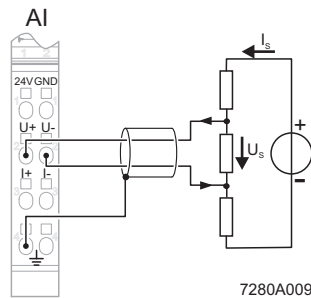

Figure 10 Differential mode voltage measurement, e.g., for shunt, jumpering, and battery charging applications

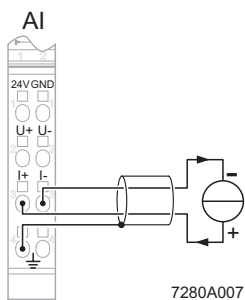

Figure 8 Current measurement

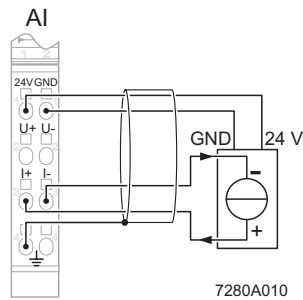

Figure 11 Active transmitter (4 mA to 20 mA)

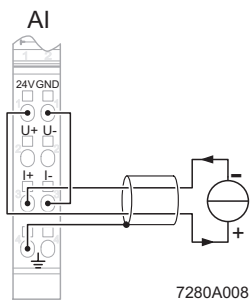
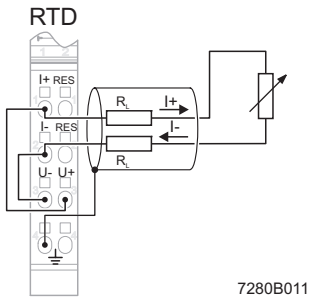

Figure 9 Passive transmitter (4 mA to 20 mA)

9.2 Connection Examples for RTD Inputs



7280B011

Figure 12 RTD 2-wire connection with connector compensation



Please refer to the connection notes for the RTD 2-wire connection in "RTD 2-Wire Connection With Connector Compensation" on page 41.

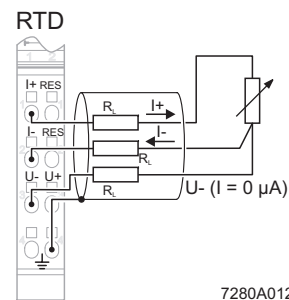

7280A012

Figure 13 RTD 3-wire connection

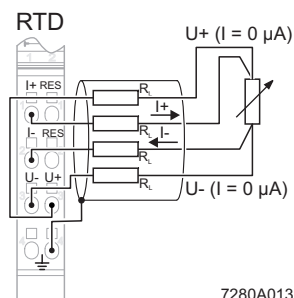

7280A013

Figure 14 RTD 4-wire connection

9.3 Connection Examples for Analog Outputs

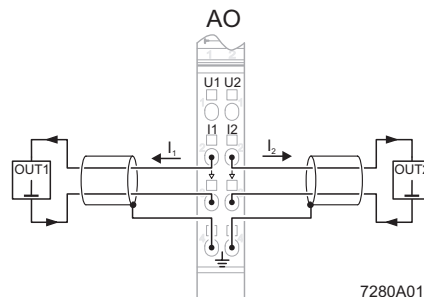

7280A014

Figure 15 Analog current output

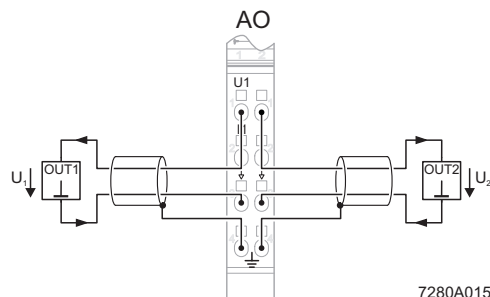

7280A015

Figure 16 Analog voltage output

10 Programming Data

ID code	F3 _{hex} (243 _{dec})
Length code	05 _{hex}
Process data channel	80 bits
Input address area	5 words
Output address area	5 words
Parameter channel (PCP)	1 word
Register length (bus)	6 words

11 Process Data

The device has 5 process data words and 1 PCP word.

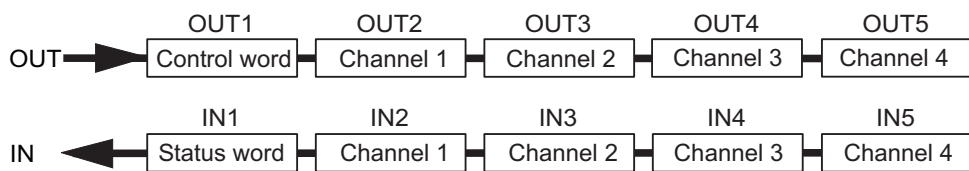

7280A026

Figure 17 Order of the process data words

11.1 Assignment of the Process Data to the Terminal Points for the "Read and Write Analog Values" Command

Assignment of the Terminal Points for Connector 12 to the Process Data Output Words

(Word.bit) view	Word	Word x															
	Bit	15	14	13	12	11	10	9	8	7	6	5	4	3	2	1	0
(Byte.bit) view	Byte	Byte 0								Byte 1							
	Bit	7	6	5	4	3	2	1	0	7	6	5	4	3	2	1	0
Word 2: Channel AO1	Signal	Terminal point 1.1: Voltage output Terminal point 1.2: Current output															
	Signal reference	Terminal point 1.3: Analog ground															
	Shielding (FE)	Terminal point 1.4, 2.4															
Word 3: Channel AO2	Signal	Terminal point 1.1: Voltage output Terminal point 1.2: Current output															
	Signal reference	Terminal point 1.3: Analog ground															
	Shielding (FE)	Terminal point 1.4, 2.4															

Assignment of the Terminal Points to the Process Data Input Words

(Word.bit) view	Word	Word x															
	Bit	15	14	13	12	11	10	9	8	7	6	5	4	3	2	1	0
(Byte.bit) view	Byte	Byte 0								Byte 1							
	Bit	7	6	5	4	3	2	1	0	7	6	5	4	3	2	1	0
AI Word 2: Channel 1 (connector 4) Word 3: Channel 2 (connector 6) Word 4: Channel 3 (connector 8) Word 5: Channel 4 (connector 10)	Signal	Terminal point 1.2: Positive voltage input Terminal point 1.3: Positive current input															
	Signal reference	Terminal point 2.2: Negative voltage input Terminal point 2.3: Negative current input															
	Shielding (FE)	Terminal point 1.4, 2.4															
RTD Word 2: Channel 1 (connector 5) Word 3: Channel 2 (connector 7) Word 4: Channel 3 (connector 9) Word 5: Channel 4 (connector 11)	Signal	Terminal point 2.3: Voltage input for RTD sensor															
	Signal reference	Terminal point 1.3 (negative voltage input for RTD sensor)															
	Constant current supply	Terminal point 1.1 (positive constant current supply) Terminal point 1.2 (negative constant current supply)															
	Shielding (FE)	Terminal point 1.4, 2.4															

12 OUT Process Data Words

Five OUT process data words are available.

The first output word (OUT1) represents the control word, the following words (OUT2 to OUT5) each refer to an analog channel. They are used for channel-specific configuration and to output analog values. As confirmation for a control word action, the first input word contains a partial copy of the control word.

		OUT1															
		Byte 0							Byte 1								
Bit		15	14	13	12	11	10	9	8	7	6	5	4	3	2	1	0
Assignment		Command code							0	0	0	0	0	0	0	0	

Bit 15 to bit 8 (command code)

Bit 15 to Bit 8	OUT1	Command Function
0 1 0 0 0 0 0 0	40xx _{hex}	Configure device. The channel parameters of the four channels are configured in OUT2 to OUT5.
		Read configuration. The configuration of each channel is displayed channel-by-channel in IN2.
0 0 0 1 0 0 0 0	1000 _{hex}	Configuration channel 1
0 0 0 1 0 0 0 1	1100 _{hex}	Configuration channel 2
0 0 0 1 0 0 1 0	1200 _{hex}	Configuration channel 3
0 0 0 1 0 0 1 1	1300 _{hex}	Configuration channel 4
		Read and write analog values. The analog values for the input channels are displayed in IN2 to IN5. The analog values for the output channels are displayed in OUT2 and OUT3.
0 0 0 0 0 0 0 0	0000 _{hex}	OUT process data not transmitted, the analog outputs are not modified.
0 0 0 0 0 0 0 1	0100 _{hex}	The analog outputs accept the value specified via OUT2 and OUT3.
0 0 1 1 1 1 0 0	3C00 _{hex}	Read device data. The firmware version and the device ID are displayed in IN2, see "Input Words IN2 to IN5" on page 23.

13 IN Process Data Words

13.1 Input Word IN1 (Status Word)

		OUT1															
		Byte 0							Byte 1								
Bit		15	14	13	12	11	10	9	8	7	6	5	4	3	2	1	0
Assignment	EB	Mirrored command code*							0	0	0	0	0	0	0	0	0

Error bit:

- EB = 0 No error has occurred.
- EB = 1 An error has occurred.

The error bit is available as a group error message. Possible errors and their effects are listed in "Diagnostics" on page 38.

*** Mirrored command code:**

A command code mirrored from the control word. Here, the MSB is suppressed.

13.2 Input Words IN2 to IN5

The measured values, firmware version or configuration are transmitted to the controller board or the computer via IN process data words IN2 to IN5 according to the configuration.

IN1*	IN2	IN3	IN4	IN5
	Configure device.			
40xx _{hex}	Configuration data following transmission to the channels			
	Configuration data channel 1	Configuration data channel 2	Configuration data channel 3	Configuration data channel 4
	Read configuration.			
1000 _{hex}	Configuration channel 1	Not relevant	Not relevant	Not relevant
1100 _{hex}	Configuration channel 2			
1200 _{hex}	Configuration channel 3			
1300 _{hex}	Configuration channel 4			
	Read and write analog values.			
00xx _{hex} 01xx _{hex}	Measured value of the analog input channel 1	Measured value of the analog input channel 2	Measured value of the analog input channel 3	Measured value of the analog input channel 4
	Read device data.			
3C00 _{hex}	Firmware version and device ID, see below	Not relevant	Not relevant	Not relevant

* Input data IN1 contains the error bit and the mirrored command code.

Example for "Read device data":

		IN2															
		15	14	13	12	11	10	9	8	7	6	5	4	3	2	1	0
Bit																	
Assignment (hex)		1				2				3				4			
Meaning		Firmware Version 1.23												Device ID 4 _{hex}			

14 Formats for the Representation of Measured Values (IN2 to IN5)

14.1 Format: "IB IL" (Default Setting)

The measured value is represented in bits 14 to 0. An additional bit (bit 15) is available as a sign bit.

Measured value representation in "IB IL" format (15 bits)

MSB														LSB	
15	14	13	12	11	10	9	8	7	6	5	4	3	2	1	0
SB	Analog value														

SB Sign bit

This format supports extended diagnostics. Values $> 8000_{\text{hex}}$ and $< 8100_{\text{hex}}$ indicate an error. Following an error message in the status word (error bit), the following errors/messages are displayed in words IN2 to IN5:

Input Data Word (hex)	Errors
8001	Ovrange
8002	Open circuit
8004	Measured value invalid
8020	Sensor and/or analog supply not present
8040	Module faulty
8080	Underrange

Significant Measured Values

Input Data Word (Two's Complement)		0 V to 10 V U_{Input}	± 10 V U_{Input}	0 V to 5 V U_{Input}	± 5 V U_{Input}	0 mA to 20 mA I_{Input}	± 20 mA I_{Input}	4 mA to 20 mA I_{Input}
hex	dec	V	V	V	V	mA	mA	mA
8001	Ovrange	$> +10.837$	$> +10.837$	$> +5.419$	$> +5.419$	$> +21.6747$	$> +21.6747$	$> +21.339733$
7F00	32512	+10.837	+10.837	+5.419	+5.419	+21.6747	+21.6747	+21.339733
7530	30000	+10.0	+10.0	+5.0	+5.0	+20.0	+20.0	+20.0
0001	1	$+333.33 \mu\text{V}$	$+333.33 \mu\text{V}$	$+166.67 \mu\text{V}$	$+166.67 \mu\text{V}$	$+0.6667 \mu\text{A}$	$+0.6667 \mu\text{A}$	+4.0005333
0000	0	≤ 0	0	≤ 0	0	≤ 0	0	+4.0 ... +3.2
FFFF	-1	–	$-333.33 \mu\text{V}$	–	$-166.67 \mu\text{V}$	–	$-0.6667 \mu\text{A}$	–
8AD0	-30000	–	-10.0	–	-5.0	–	-20.0	–
8100	-32512	–	-10.837	–	-5.419	–	-21.6747	–
8080	Underrange	–	< -10.837	–	< -5.419	–	< -21.6747	–
8002	Open circuit	–	–	–	–	–	–	$< +3.2$

Input Data Word (Two's Complement)		R: 0 ... 3.2 kΩ R _{Input}	R: 0 ... 9.5 kΩ R _{Input}	Pt and Ni
hex	dec	Ω	Ω	°C
8001	Overrange	> 3200	> 10000	> Limit value
251C	9500	–	9500	–
03E8	1000	100.0	1000	+100.0
0001	1	+0.1	+1.0	+0.1
0000	0	≤0	≤0	0
FFFF	-1	–	–	-0.1
FC18	-1000	–	–	-100.0
8080	Underrange	–	–	< Limit value



For the limit values, please refer to "Limit Values for Temperature Measurement" on page 9.

Output Data Word		0 V to 10 V U _{Output}	±10 V U _{Output}	0 V to 5 V U _{Output}	±5 V U _{Output}	0 mA to 20 mA I _{Output}	±20 mA I _{Output}	4 mA to 20 mA I _{Output}
hex	dec	V	V	V	V	mA	V	mA
8001	Overrange	+10.837	+10.837	+5.419	+5.419	+21.6764	+10.837	+21.3397
7FFF to 7F01	–	+10.837	+10.837	+5.419	+5.419	+21.6764	+21.6764	+21.3397
7F00	+32512	+10.837	+10.837	+5.419	+5.419	+21.6764	+21.6764	+21.3397
7530	+30000	+10.0	+10.0	+5.0	+5.0	+20.0	+20.0	+20.0
3A98	+15000	+5.0	+5.0	+2.5	+2.5	+10.0	+10.0	+12.0
0001	+1	+333.33 μV	+333.33 μV	+166.67 μV	+166.67 μV	+0.6667 μA	+0.6667 μA	+4.000533
0000	0	0	0	0	0	0	0	+4.0
FFFF	-1	0	-333.33 μV	0	-166.67 μV	0	-0.6667 μA	+4.0
C568	-15000	0	-5.0	0	-2.5	0	-10.0	+4.0
8AD0	-30000	0	-10.0	0	-5.0	0	-20.0	+4.0
8100	-32512	0	-10.837	0	-5.419	0	-21.6764	+4.0
80FF to 8000 without 8001, 8080, 8002	–	HOLD	HOLD	HOLD	HOLD	HOLD	HOLD	HOLD
8080	Underrange	0	-10.837	0	-5.419	0	-10.837	HOLD
8002	Line break	HOLD	HOLD	HOLD	HOLD	HOLD	HOLD	0

14.2 Format: "RT"

The measured value is represented in bits 14 to 0. An additional bit (bit 15) is available as a sign bit.

Measured value representation in "RT" format (15 bits)

MSB														LSB	
15	14	13	12	11	10	9	8	7	6	5	4	3	2	1	0
SB	Analog value														

SB Sign bit

Significant Measured Values

Input Data Word		0 V to 10 V U_{Input}	± 10 V U_{Input}	0 V to 5 V U_{Input}	± 5 V U_{Input}	0 mA to 20 mA I_{Input}	± 20 mA I_{Input}	4 mA to 20 mA I_{Input}
hex	dec	V	V	V	V	mA	mA	mA
7FFF	32767	$\geq +10.0$	$\geq +10.0$	$\geq +5.0$	$\geq +5.0$	$\geq +20.0$	$\geq +20.0$	$\geq +20.0$
0001	+1	$+305.18 \mu\text{V}$	$+305.18 \mu\text{V}$	$+152.6 \mu\text{V}$	$+152.6 \mu\text{V}$	$+0.610 \mu\text{A}$	$+0.610 \mu\text{A}$	$+4.000488 \mu\text{A}$
0000	0	≤ 0	0	≤ 0	0	≤ 0	0	4.0
FFFF	-1	-	$-305.18 \mu\text{V}$	-	$-152.6 \mu\text{V}$	-	$-0.610 \mu\text{A}$	-
8001	-32767	-	≤ -10.0	-	≤ -5.0	-	≤ -20.0	< 3.7

Output Data Word		0 V to 10 V U_{Output}	± 10 V U_{Output}	0 V to 5 V U_{Output}	± 5 V U_{Output}	0 mA to 20 mA I_{Output}	± 20 mA I_{Output}	4 mA to 20 mA I_{Output}
hex	dec	V	V	V	V	mA	V	mA
7FFF	+32767	+10.0	+10.0	+5.0	+5.0	+20.0	+20.0	+20.0
0001	+1	$+305.18 \mu\text{V}$	$+305.18 \mu\text{V}$	$+152.6 \mu\text{V}$	$+152.6 \mu\text{V}$	$+0.610 \mu\text{A}$	$+0.610 \mu\text{A}$	+4.000488
0000	0	≤ 0	0	≤ 0	0	≤ 0	≤ 0	+4.0
FFFF	-1	0	$-305.18 \mu\text{V}$	0	$-152.6 \mu\text{V}$	0	$-0.610 \mu\text{A}$	+4.0
8001	-32767	0	-10.0	0	-5.0	0	-20.0	+4.0

14.3 Format: "S7-Compatible"

The measured value is represented in bits 14 to 0. An additional bit (bit 15) is available as a sign bit.

Measured value representation in "S7-compatible" format

MSB															LSB
15	14	13	12	11	10	9	8	7	6	5	4	3	2	1	0
SB	Analog value														

SB Sign bit

Significant Measured Values

Input Data Word		0 V to 10 V U _{Input}	±10 V U _{Input}	0 V to 5 V U _{Input}	±5 V U _{Input}	0 mA to 20 mA I _{Input}	±20 mA I _{Input}	4 mA to 20 mA I _{Input}
hex	dec	V	V	V	V	mA	mA	mA
7FFF	Overrange	> +11.759	> +11.759	> +5.879	> +5.879	> +23.5157	> +23.5157	> +22.8142
7EFF	+32511	+11.759	+11.759	+5.879	+5.879	+23.5157	+23.5157	+22.8142
6C00	+27648	+10.0	+10.0	+5.0	+5.0	+20.0	+20.0	+20.0
0001	+1	+361.69 µV	+361.69 µV	+180.85 µV	+180.85 µV	+0.7234 µA	+0.7234 µA	+4.000578
0000	0	≤ 0	0	≤ 0	0	≤ 0	0	+4.0
FFFF	-1	–	-361.69 µV	–	-180.85 µV	–	-0.7234 µA	+3.999422
F940	-1728	–	-0.625	–	-0.3125	–	-1.25	+3.0
8000	Line break	–	–	–	–	–	–	< +1.1852
9400	-27648	–	-10	–	-5.0	–	-20.0	–
8100	-32519	–	-11.759	–	-5.879	–	-23.516	–
8000	Underrange	–	< -11.759	–	< -5.879	–	< -23.516	–

Formula for Calculating the Measured Value from the Process Data Input Value for the 4 mA to 20 mA Measuring Range

Measured value = PD IW x 0.0005787 mA + 4 mA

PD IW = Process data

Example 1

PD IW 6C00_{hex} = 27648_{dec}
 Value x resolution 27648 x 0.0005787 mA = 16 mA
 + 4 mA 16 mA + 4 mA = 20 mA
 Measured value 20 mA

Example 2

PD IW F940_{hex} -> FFFF_{hex} - F940_{hex} + 1 = -1728_{dec}
 Value x resolution -1728 x 0.0005787 mA = -1 mA
 + 4 mA -1 mA + 4 mA = 3 mA
 Measured value 3 mA

Input Data Word (Two's Complement)		R: 0 ... 3.2 k Ω R_{Input}	R: 0 ... 9.5 k Ω R_{Input}	Pt and Ni
hex	dec	Ω	Ω	$^{\circ}\text{C}$
7FFF	Overrange	> 3200	> 10000	> Limit value
251C	9500	–	9500	–
03E8	1000	100.0	1000	+100.0
0001	1	0.1	1	+0.1
0000	0	≤ 0	≤ 0	0
FFFF	-1	–	–	-0.1
FC18	-1000	–	–	-100.0
8000	Underrange	–	–	< Limit value

Output Data Word		0 V to 10 V U_{Output}	± 10 V U_{Output}	0 V to 5 V U_{Output}	± 5 V U_{Output}	0 mA to 20 mA I_{Output}	± 20 mA I_{Output}	4 mA to 20 mA I_{Output}
hex	dec	V	V	V	V	mA	mA	mA
7FFF to 7F00	Overrange	0	0	0	0	0	0	0
7EFF	+32511	+11.7589	+11.7589	+5.8800	+5.8800	+23.5150	+23.5150	+22.8100
6C00	+27648	+10.0000	+10.0000	+5.0000	+5.0000	+20.0	+20.0	+20.0
5100	+20736	+7.5000	+7.5000	+3.7500	+3.7500	+15.0	+15.0	+16.0
1	+1	+361.69 μV	+361.69 μV	+180.845 μV	+180.845 μV	+0.7234 μA	+0.7234 μA	+4.000578
0	0	0	0	0	0	0	0	+4.0
FFFF	-1	0	-361.69 μV	0	-180.845 μV	0	-0.7234 μA	+3.99942
E501	-6911	0	-2.4996	0	-1.2498	0	-4.99942	+0.578 μA
E500	-6912	0	-2.5000	0	-1.2500	0	-5.0	0
AF00	-20736	0	-7.5000	0	-3.7500	0	-15.0	0
9400	-27648	0	-10.0000	0	-5.0000	0	-20.0	0
8100	-32511	0	-11.7589	0	-5.8800	0	-23.5157	0
80FF to 8000	Underrange	0	0	0	0	0	0	0

14.4 Format: "Standardized Representation"

The data is represented in bits 14 to 0. An additional bit (bit 15) is available as a sign bit.

In this format, data is standardized to the measuring range and represented in such a way that it indicates the corresponding value without conversion. In this format one bit has the value of 1 mV or 1 μ A.

Measured value representation in "standardized representation" format

MSB														LSB	
15	14	13	12	11	10	9	8	7	6	5	4	3	2	1	0
SB	Analog value														

SB Sign bit

This format supports extended diagnostics. Values $> 8000_{\text{hex}}$ and $< 8100_{\text{hex}}$ indicate an error. Following an error message in the status word (error bit), the following errors/messages are displayed in words IN2 to IN5:

Input Data Word (hex)	Errors
8001	Overrange
8002	Open circuit
8004	Measured value invalid
8020	Analog supply not present
8040	Module faulty
8080	Underrange

Significant Measured Values

Input Data Word		0 V to 10 V U_{Input}	± 10 V U_{Input}	0 V to 5 V U_{Input}	± 5 V U_{Input}	0 mA to 20 mA I_{Input}	± 20 mA I_{Input}	4 mA to 20 mA I_{Input}
hex	dec	V	V	V	V	mA	mA	mA
8001	Overrange	$> +10.837$	$> +10.837$	$> +5.419$	$> +5.419$	$> +21.6747$	$> +21.6747$	$\geq +21.339$
4E20	+20000	–	–	–	–	+20.0	+20.0	–
2710	+10000	+10.0	+10.0	–	–	+10.0	+10.0	+14.0
1388	+5000	+5.0	+5.0	+5.0	+5.0	+5.0	+5.0	+9.0
0001	+1	+0.001	+0.001	+0.001	+0.001	0.001	0.001	+4.001
0000	0	≤ 0	0	≤ 0	0	≤ 0	0	+4.0 ... +3.2
FFFF	-1	–	-0.001	–	-0.001	–	-0.001	–
EC78	-5000	–	-5.0	–	-5.0	–	-5.0	–
D8F0	-10000	–	-10.0	–	–	–	-10.0	–
B1E0	-20000	–	–	–	–	–	-20.0	–
8080	Underrange	–	< -10.837	–	< -5.419	–	< -21.6747	–
8002	Open circuit	–	–	–	–	–	–	$< +3.2$

Input Data Word (Two's Complement)		R: 0 ... 3.2 k Ω R _{Input}	R: 0 ... 9.5 k Ω R _{Input}	Pt and Ni °C
hex	dec	Ω	Ω	°C
8001	Overrange	> 3200	> 10000	> Limit value
251C	9500	–	9500	–
03E8	1000	100.0	1000	+100.0
0001	1	+0.1	+1.0	+0.1
0000	0	≤ 0	≤ 0	0
FFFF	-1	–	–	-0.1
FC18	-1000	–	–	-100.0
8080	Underrange	–	–	< Limit value

Output Data Word		0 V to 10 V U _{Output}	± 10 V U _{Output}	0 V to 5 V U _{Output}	± 5 V U _{Output}	0 mA to 20 mA I _{Output}	± 20 mA I _{Output}	4 mA to 20 mA I _{Output}
hex	dec	V	V	V	V	mA	mA	mA
8001	Overrange	+10.837	+10.837	+5.419	+5.419	+21.674	+21.674	+21.3397
7FFF to 54AB	–	+10.837	+10.837	+5.419	+5.419	+21.674	+21.674	+21.3397
54AA	+21674	+10.837	+10.837	+5.419	+5.419	+21.674	+20.0	+21.3397
4E20	+20000	+10.837	+10.837	+5.419	+5.419	+20.0	+20.0	+21.3397
2710	+10000	+10.0	+10.0	+5.419	+5.419	+15.0	+10.0	+14.0
1388	+5000	+5.0	+5.0	+5.0	+5.0	+5.0	+5.0	+9.0
0001	1	+1 mV	+1 mV	+1 mV	+1 mV	+1 μ A	+1 μ A	+4.001
0000	0	0	0	0	0	0	0	+4.0
FFFF	-1	0	-1 mV	0	-1 mV	0	-1 μ A	+4.0
EC78	-5000	0	-5.0	0	-5.0	0	-5.0	+4.0
D8F0	-10000	0	-10.0	0	-5.419	0	-10.0	+4.0
B1E0	-20000	0	-10.837	0	-5.419	0	-20.0	+4.0
AB56	-21674	0	-10.837	0	-5.419	0	-21.674	+4.0
AB55 to 8100	–	0	-10.837	0	-5.419	0	-21.674	+4.0
80FF to 8000 without 8001, 8080, 8002	–	HOLD	HOLD	HOLD	HOLD	HOLD	HOLD	HOLD
8080	Underrange	0	-10.837	0	-5.419	0	-21.674	HOLD
8002	Line break	HOLD	HOLD	HOLD	HOLD	HOLD	HOLD	0

15 Configuration

Module configuration is only required if the channels are not to be operated with the default values (see "Parameters for Configuration" on page 32).

You can **either** configure the module via process data **or** via PCP and transmit analog values accordingly.

If the module has been configured via PCP, subsequent configuration via process data is only possible if configuration via process data is permitted with the "Config Table" PCP object. To do this, in the "AO format, AI format, system bits" element set "Conf" bit = 1. As long as "Conf" = 0, the error bit is set in the status word when an attempt is made to configure via process data.

16 Configuration via Process Data

Five OUT process data words are available.

The first output word represents the control word, the following words each refer to an analog channel. As confirmation for a control word action, the first input word contains a partial copy of the control word.

For the device configuration, channel-specific parameter data is set in the relevant channel output words. Once configuration has been completed, and depending on the format set, the measured values in the corresponding input words are either transmitted to the controller board or to the computer.

	OUT1							OUT2	OUT3	OUT4	OUT5
Bit	15 to 8	7	6	5	4	3	2	1	0		
	40 _{hex}	0	0	0	PF	AO format	AI format	Configuration AI1/AO1	Configuration AI2/AO2	Configuration AI3	Configuration AI4

16.1 Output Word OUT1 (Control Word) for Command Code 40xx_{hex} (Configure Device)

		OUT1															
		Byte 0								Byte 1							
Bit	Assignment	15	14	13	12	11	10	9	8	7	6	5	4	3	2	1	0
		Command code 40 _{hex}								0	0	0	PF	AO format	AI format		

Bit 4

Code (bin)	PF (Peripheral Fault in the Event of Sensor Error)
0	Not permitted (default)
1	Permitted

Bit 3 and bit 2

Code (bin)	AO Format
00	IB IL (15 bits) (default)
01	RT
10	S7-compatible
11	Standardized representation

Bit 1 and bit 0

Code (bin)	AI Format
00	IB IL (15 bits) (default)
01	RT
10	S7-compatible
11	Standardized representation

16.2 Output Words OUT2 to OUT5 (Configuration)

Each channel can be configured independently of the other channels. The first channel is configured via the second output word, the second channel via the third output word, etc.

If the format "IB IL" is set, the error code "measured value invalid" is output during configuration.

If the configuration is invalid, a corresponding error message is output in the status word. The configuration is stored in a volatile memory.

For command 40x_{hex}, specify the parameters for the appropriate channels 1 to 4 in OUT2 to OUT5. The parameter words are only evaluated by this command.

Configuration words for analog inputs and outputs:

		OUTx (x = 2 to 5)															
Byte		Byte 0							Byte 1								
Bit		15	14	13	12	11	10	9	8	7	6	5	4	3	2	1	0
Assignment		Wire		AO reset behavior		Res.	AO output range		Res.	AI filter	AI measuring range						

- **"Wire"** indicates the number of wires for a resistance measurement. It is only relevant for the "Linear R ...", "Pt ...", and "Ni ..." AI measuring range options (codes 7_{hex} to E_{hex}).
- **"AO reset behavior"** indicates the status of the analog outputs in the event of an INTERBUS reset and following power up. The failsafe value must be specified retentively via the Config Table PCP object.
- **"AO output range"** indicates the range for the analog outputs.
- **"AI filter"** indicates the time for the digital filter.
- **"AI measuring range"** indicates the range for the analog inputs.

An error message is generated during configuration due to the following reasons:

- A reserved value was used.
- Current or voltage is configured for "AI measuring range" AND 3 or 4-wire is configured for "Wire".
- Configuration has already been carried out via PCP.

Parameters for Configuration

The values displayed in **bold** are default settings.

Bit 15 and bit 14

Code (bin)	Wire
00	2-wire (default)
01	3-wire
10	4-wire, 2-wire with connector compensation
11	Reserved

Bit 13 and bit 12

Code (bin)	AO Reset Behavior
00	Hold (default)
01	Reset
10	Failsafe value
11	Reserved

Bit 10 to bit 8

Code (bin)	Code (hex)	AO Output Range
000	0	0 V to 10 V (default)
001	1	±10 V
010	2	0 V to 5 V
011	3	±5 V
100	4	0 mA to 20 mA
101	5	±20 mA
110	6	4 mA to 20 mA
111	7	Reserved

Bit 6

Code (bin)	AI Filter
0	4.5 ms (default)
1	1.1 ms

Bit 5 to bit 0

Code			AI Measuring Range
(dec)	(bin)	(hex)	
0	00 0000	0	0 V to 10 V (default)
1	00 0001	1	±10 V
2	00 0010	2	0 V to 5 V
3	00 0011	3	±5 V
4	00 0100	4	0 mA to 20 mA
5	00 0101	5	±20 mA
6	00 0110	6	4 mA to 20 mA
7	00 0111	7	Linear R: 0 Ω to 3200 Ω
8	00 1000	8	Linear R: 0 Ω to 9500 Ω

Code			AI Measuring Range
(dec)	(bin)	(hex)	
9	00 1001	9	Pt 100 DIN
10	00 1010	A	Pt 500 DIN
11	00 1011	B	Pt 1000 DIN
12	00 1100	C	Ni 100 DIN
13	00 1101	D	Ni 1000 DIN
14	00 1110	E	Ni 1000 L&S
		F - 3F	Reserved

16.3 Example for the Module Configuration via Process Data



For easy module configuration a function block can be downloaded at www.phoenixcontact.com.

All input channels are configured differently.

PF	AO Format	AI Format	Configuration Value OUT1 (hex)
Not permitted	IB IL	IB IL	xx00

OUTx	Channel	Wire	AO Reset Behavior	AO Output Range	Filter Time	AI Measuring Range	Configuration Value OUTx (hex)
OUT2	AI1/AO1	2-wire	Hold	0 mA to 20 mA	4.5 ms	0 V to 10 V	0400
OUT3	AI2/AO2	2-wire	Hold	±10 V	1.1 ms	0 mA to 20 mA	0144
OUT4	AI3	4-wire	–	–	4.5 ms	Pt 100 DIN	8009
OUT5	AI4	2-wire with connector compensation	–	–	4.5 ms	Pt 1000 DIN	800B

Step	Process Data	Meaning
1	OUT1 = 0000 _{hex}	Ensures that the following values for OUT2 and OUT3 are not evaluated as an analog output
2	Wait until IN1 = 0000 _{hex}	Awaiting confirmation
3	OUT5 = 800B _{hex} OUT4 = 8009 _{hex} OUT3 = 0144 _{hex} OUT2 = 0400 _{hex} OUT1 = 4000 _{hex}	Specified configuration
4	Wait until IN1 = 4000 _{hex}	Awaiting confirmation

Step	Process Data	Meaning
5	OUT1 = 0000 _{hex}	Requesting the measured values of channels 1 to 4
6	Wait until IN1 = 0000 _{hex}	Awaiting confirmation
7	OUT3 = analog value AO2 OUT2 = analog value AO1 OUT1 = 0100 _{hex}	Outputting analog values
8	Wait until IN1 = 0100 _{hex}	Awaiting confirmation
9	Measured value channel 1 = IN2, ..., Measured value channel 4 = IN5 OUT1 = 0100 _{hex}	Reading measured values

17 Configuration via PCP

By default upon delivery, the device is configured according to the default settings (see "Parameters for Configuration" on page 32).

In PCP mode, the device is configured with the "Config Table" object.

Index	Data Type	N	L	Meaning	Object Name	Rights
0080 _{hex}	Array of Unsigned 16	7	2	Device configuration	Config Table	rd/wr

N: Number of elements

rd: Read access permitted

L: Length of an element in bytes

wr: Write access permitted

Config Table Object

Configure the device using this object.

Object Description

Object	Config Table	
Access	Read, write	
Data type	Array of Unsigned 16	7 x 2 bytes
Index	0080 _{hex}	
Subindex	00 _{hex} Write all elements 01 _{hex} Configuration channel 1 (AI1, AO1) 02 _{hex} Configuration channel 2 (AI2, AO2) 03 _{hex} Configuration channel 3 (AI3) 04 _{hex} Configuration channel 4 (AI4) 05 _{hex} AO format, AI format, system bits 06 _{hex} Failsafe value AO1 07 _{hex} Failsafe value AO2	
Length (bytes)	0E _{hex} Subindex 00 _{hex} 02 _{hex} Subindex 01 _{hex} to 07 _{hex}	
Data	Device configuration	

Element Value Range

The "**Configuration channel x**" elements have the following structure:

		OUTx (x = 2 to 5)															
Bit		15	14	13	12	11	10	9	8	7	6	5	4	3	2	1	0
Assignment		Wire		AO reset			Res.	AO output range			AI filter		AI measuring range				

For the value ranges for the individual parameters, please refer to Section "Parameters for Configuration" on page 32.

The "**AO format, AI format, system bits**" element has the following structure:

Bit		15	14	13	12	11	10	9	8	7	6	5	4	3	2	1	0
Assignment		0	0	0	0	AO format	AI format	0	0	0	0	0	0	0	PF	AOV	Conf

For the value ranges for the "AO format" and "AI format" parameters, please refer to Section "Parameters for Configuration" on page 32.

"PF"

If bit 2 = 1, a peripheral fault is generated in the event of a sensor problem (overrange, underrange, open circuit).

"AOV"

If bit 1 = 1, the "Analog Out Values" object may be written. This specifies that analog values for AO1 and AO2 are specified via PCP and not via process data.

"Conf"

If bit 0 = 1, configuration via process data is permitted (command code 40xx_{hex}).

The format of the failsafe value must be the Inline format.

If an invalid configuration is specified, a negative confirmation is generated with error message 08_{hex}, 00_{hex} or xx30_{hex}. The low byte of the additional error code is 30_{hex} (value is out of range), the high byte contains the number of the affected element.

Example: Config Table is completely written with data (subindex 00) and the entry for channel 2 is invalid. In this case, the additional error code is equal to 0230_{hex}.

18 PCP Communication



For information on PCP communication, please refer to the IBS SYS PCP G4 UM E and IBS PCP COMPACT UM E user manuals.

18.1 Object Dictionary

Index	Data Type	N	L	Meaning	Object Name	Rights
0080 _{hex}	Array of Unsigned 16	7	2	Device configuration	Config Table	rd/wr
0081 _{hex}	Array of Unsigned 16	4	2	Input Data	Analog In Values	rd
0085 _{hex}	Array of Unsigned 16	2	2	Output data	Analog Out Values	rd/wr
0018 _{hex}	Record	6	17	Diagnostic status	DiagState	rd

N: Number of elements

rd: Read access permitted

L: Length of an element in bytes

wr: Write access permitted

18.2 Object Description

Config Table Object

Configure the device using this object. See "Config Table Object" on page 34.

Analog In Values Object

The elements of this object contain the analog values of the channels in the format that was selected for this channel.

Object Description

Object	Analog In Values	
Access	Read	
Data type	Array of Unsigned 16	4 x 2 bytes
Index	0081 _{hex}	
Subindex	00 _{hex}	Read all elements
	01 _{hex}	Analog value channel 1 (AI1)
	02 _{hex}	Analog value channel 2 (AI2)
	03 _{hex}	Analog value channel 3 (AI3)
	04 _{hex}	Analog value channel 4 (AI4)
Length (bytes)	08 _{hex}	Subindex 00 _{hex}
	02 _{hex}	Subindex 01 _{hex} to 04 _{hex}
Data	Analog values of the channels (input data)	

Analog Out Values Object

The elements of this object specify the analog values of the output channels in the format that was selected for the relevant channel.

Write access must be enabled in order to ensure error-free writing. To do this, in the "Config Table" object in element 5 set bit 1 (AOV) = 1.

If write access is not enabled, a negative write confirmation will be generated with error message 08, 00, 0022_{hex} (Service cannot be executed at present).

Object Description

Object	Analog Out Values	
Access	Read/write	
Data type	Array of Unsigned 16	2 x 2 bytes
Index	0085 _{hex}	
Subindex	00 _{hex}	Read/write all elements
	01 _{hex}	Analog value channel 1 (AO1)
	02 _{hex}	Analog value channel 2 (AO2)
Length (bytes)	04 _{hex}	Subindex 00 _{hex}
	02 _{hex}	Subindex 01 _{hex} to 02 _{hex}
Data	Analog values of the channels (output data)	

DiagState Object

The elements of this object contain the current diagnostic status of the device.

Object Description

Object	DiagState																					
Access	Read																					
Data type	Record																					
Index	0018 _{hex}																					
Subindex	<table border="0"> <tr> <td>00_{hex}</td> <td>Read all elements</td> <td></td> </tr> <tr> <td>01_{hex}</td> <td>Consecutive no.</td> <td>Unsigned 16 (2 bytes)</td> </tr> <tr> <td>02_{hex}</td> <td>Priority</td> <td>Unsigned 8 (1 byte)</td> </tr> <tr> <td>03_{hex}</td> <td>Channel</td> <td>Unsigned 8 (1 byte)</td> </tr> <tr> <td>04_{hex}</td> <td>Code</td> <td>Unsigned 16 (2 bytes)</td> </tr> <tr> <td>05_{hex}</td> <td>MoreFollows</td> <td>Unsigned 8 (1 byte)</td> </tr> <tr> <td>06_{hex}</td> <td>Text</td> <td>OctetString (10 bytes)</td> </tr> </table>	00 _{hex}	Read all elements		01 _{hex}	Consecutive no.	Unsigned 16 (2 bytes)	02 _{hex}	Priority	Unsigned 8 (1 byte)	03 _{hex}	Channel	Unsigned 8 (1 byte)	04 _{hex}	Code	Unsigned 16 (2 bytes)	05 _{hex}	MoreFollows	Unsigned 8 (1 byte)	06 _{hex}	Text	OctetString (10 bytes)
00 _{hex}	Read all elements																					
01 _{hex}	Consecutive no.	Unsigned 16 (2 bytes)																				
02 _{hex}	Priority	Unsigned 8 (1 byte)																				
03 _{hex}	Channel	Unsigned 8 (1 byte)																				
04 _{hex}	Code	Unsigned 16 (2 bytes)																				
05 _{hex}	MoreFollows	Unsigned 8 (1 byte)																				
06 _{hex}	Text	OctetString (10 bytes)																				
Length (bytes)	<table border="0"> <tr> <td>11_{hex}</td> <td>Subindex 00_{hex}</td> </tr> <tr> <td>01_{hex}</td> <td>Subindex 02_{hex}, 03_{hex}, 05_{hex}</td> </tr> <tr> <td>02_{hex}</td> <td>Subindex 01_{hex}, 04_{hex}</td> </tr> <tr> <td>0A_{hex}</td> <td>Subindex 06_{hex}</td> </tr> </table>	11 _{hex}	Subindex 00 _{hex}	01 _{hex}	Subindex 02 _{hex} , 03 _{hex} , 05 _{hex}	02 _{hex}	Subindex 01 _{hex} , 04 _{hex}	0A _{hex}	Subindex 06 _{hex}													
11 _{hex}	Subindex 00 _{hex}																					
01 _{hex}	Subindex 02 _{hex} , 03 _{hex} , 05 _{hex}																					
02 _{hex}	Subindex 01 _{hex} , 04 _{hex}																					
0A _{hex}	Subindex 06 _{hex}																					
Data	Diagnostic status of the device																					

	Meaning	Possible Values
Consecutive no.	Unique, consecutive error number since the last power up reset or history reset	0 to 65535
Priority	Priority of the message	If Code = 0000 _{hex} , Priority = 00 _{hex} otherwise Priority = 02 _{hex}
Channel		If Code = 0000 _{hex} , Channel = 00 _{hex} otherwise Channel = 01 _{hex} to 04 _{hex}
Code	Error code	0000 _{hex} : No error 8910 _{hex} : Overrange 8920 _{hex} : Underrange 7710 _{hex} : Cable break 5160 _{hex} : Power supply error 5010 _{hex} : Hardware fault
MoreFollows	00 _{hex} = No additional information is available for this error.	00 _{hex}
Text	The first 10 characters of the status message. Default: "Status OK"	If Code = 0000 _{hex} , Text = "Status OK" otherwise text contains error-specific information

19 Diagnostics

Error Table With Diagnostic Data and Status Indicators

Error Type	Diagnostic Data	Status Indicators
Sensor Supply		
Sensor supply failure or sensor supply voltage too low	Message in the process data: Indication of error code 8020 _{hex} in the measured value (only for "IB IL" and "standardized representation" format)	US LED is OFF, SF LED lights up red, E1 to E4 LEDs light up red
Sensor supply short circuit	Message in the process data: Indication of error code 8020 _{hex} in the measured value (only for "IB IL" and "standardized representation" format)	SF LED lights up red, Ex LED lights up red
Analog Inputs		
Open circuit during temperature measurement or in the range from 4 mA to 20 mA	Message in the process data: Indication of error code 8002 _{hex} in the measured value (only for "IB IL" and "standardized representation" format)	Ex LED lights up red
Analog Outputs		
Output value channel 1 \geq 5% of measuring range final value		LED 1 lights up yellow
Output value channel 2 \geq 5% of measuring range final value		LED 2 lights up yellow
General		
Voltage failure of the internal analog device supply (5 V and 15 V)	Message in the process data: Indication of error code 8020 _{hex} in the measured value (only for "IB IL" and "standardized representation" format) Additional peripheral fault message sent to the control system	
Faulty configuration	Message in the process data	
Module faulty (e.g., due to component failure)	Message in the process data: Indication of error code 8040 _{hex} in the measured value (only for "IB IL" and "standardized representation" format)	
Ovrange of the measuring range	Message in the process data: Indication of error code 8001 _{hex} in the measured value (only for "IB IL" and "standardized representation" format) Additional peripheral fault message sent to the control system, if this is permitted	
Underrange of the measuring range	Message in the process data: Indication of error code 8080 _{hex} in the measured value (only for "IB IL" and "standardized representation" format) Additional peripheral fault message sent to the control system, if this is permitted	



In the event of a message in the process data, the error bit is always set.

20 Channel Conversion Times and Process Data Update Time

The process data update time is determined from the sum of the channel conversion times for all four channels. The analog outputs must be maintained within these times.

The conversion time of a channel is determined from the channel parameterization and combines the filter time plus special additional times.

Channel conversion time = (Filter time + Time for resistance measurement + Measuring time for 4-wire connection) x 3-wire factor

Filter Time	Time for Resistance Measurement	4-Wire Measuring Time	3-Wire Factor
Filter 1: 4.5 ms Filter 2: 1.1 ms	0.2 ms for all resistance measurements	1 ms, if resistor is connected in 4-wire technology	2 ms, if resistor is connected in 3-wire technology; otherwise 1 ms

Example:

- Channel 1: Measuring range 0 V to 10 V, filter time = 4.5 ms
- Channel 2: Measuring range 0 mA to 20 mA, filter time = 1.1 ms
- Channel 3: Measuring range Pt 100, filter time = 4.5 ms, 4-wire
- Channel 4: Measuring range Pt 1000, filter time = 4.5 ms, 2-wire with connector compensation

Channel	Configuration [hex]	Filter Time	Time for Resistance Measurement	4-Wire Measuring Time*	3-Wire Factor	Channel Conversion Time
1	0000	4.5 ms	0 ms	0 ms	1	4.5 ms
2	0044	1.1 ms	0 ms	0 ms	1	1.1 ms
3	8009	4.5 ms	0.2 ms	1 ms	1	5.7 ms
4	800B	4.5 ms	0.2 ms	1 ms	1	5.7 ms
Process data update time = total of all channel conversion times						17 ms

* 4-wire measuring time also applies for 2-wire with connector compensation

Analog Conversion Time According to the Example Above:

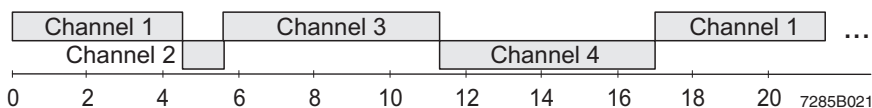

Figure 18 Analog conversion time according to the example above

21 Behavior of the Analog Outputs in the Event of INTERBUS Reset and Power Up

Both analog outputs behave independently of each other.

Event	AO Reset Behavior	Response
INTERBUS reset	Hold	Analog value is held
	Reset	If AO output range 4 mA to 20 mA is configured, 4 mA is output, otherwise 0 mA or 0 V is output
	Failsafe	The failsafe value for the corresponding channel that is specified in the "Config Table" object is output
Power up	Hold	Output of 0 V
	Reset	0 V or 0 mA
	Failsafe	0 V or 0 mA

22 Notes on Systematic and Random Errors During Resistance and Temperature Measurement

The extent of systematic and random errors (signal/noise ratio) is greatly influenced by the connection method and filter time selected. The lowest level of systematic and random deviations can be achieved by selecting 4-wire technology and a filter time of 4.5 ms.

22.1 Measures to Optimize Tolerances

- Set the filter time to 4.5 ms (default setting).
- Reduce random errors through additional application filtering.
- Minimize a large part of systematic errors through user-specific system calibration.
- Short circuit unused RTD channels.
- Increase the sensor ground (connect sensor ground, e.g., to a metal block).
Attention: Connect only one end of the shielding.
- For 2-wire connection, use the version with connector compensation.

22.2 Connection Method

RTD 4-Wire Connection

The contact resistance of the connections and the cable resistances have virtually no effect due to the 4-wire connection technology.

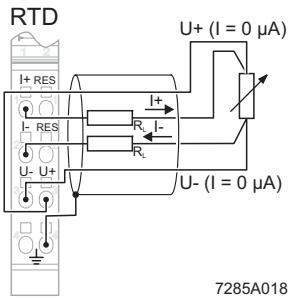

Figure 19 RTD 4-wire connection

22.3 RTD 3-Wire Connection

With 3-wire technology, the effect of the cable resistance on the measured result in the terminal is minimized by multiple measuring of the temperature-related voltage and corresponding calculations. With this connection method, one cable can be eliminated.

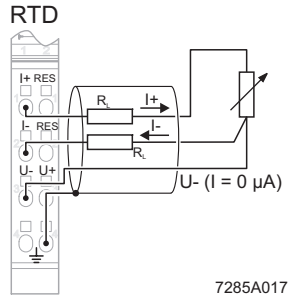

Figure 20 RTD 3-wire connection

RTD 2-Wire Connection With Connector Compensation

2-wire technology is a more cost-effective connection method. The long U+ and U- cables to the sensor are no longer needed here. They are jumpered directly at the connector. The temperature-related voltage is not directly measured at the sensor and therefore not falsified by the two cable resistances R_L . This connection method is ideal for sensors with high R_0 (e.g., Pt 1000, Ni 1000).

With 2-wire connection with connector compensation, minimized tolerances can be achieved through:

- Parameterization of the terminal on a 4-wire connection
- Direct jumpering of the U+ and U- connections at the live measuring cables

A larger conductor cross section and sensors with higher R_0 further improve the tolerances of these connection versions.

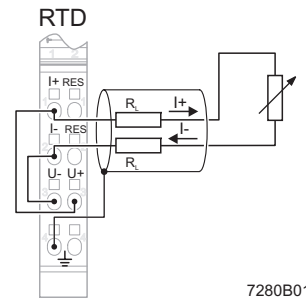

Figure 21 RTD 2-wire connection with connector compensation

22.4 Systematic Errors During Temperature Measurement With 2-Wire Technology

With 2-wire connection method, the cable resistances are in series for the sensor resistance and result in systematic measuring errors. This is described in greater detail below.

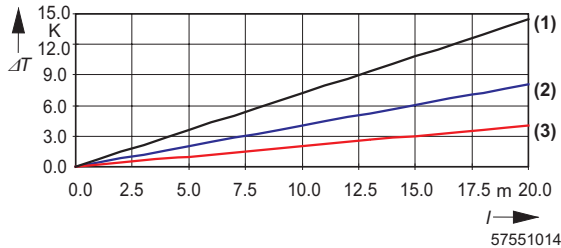

Figure 22 Systematic temperature measuring error ΔT depending on the cable length l

Curves depending on the cable cross section A

- (1) Temperature measuring error for $A = 0.14 \text{ mm}^2$
- (2) Temperature measuring error for $A = 0.25 \text{ mm}^2$
- (3) Temperature measuring error for $A = 0.50 \text{ mm}^2$

(Measuring error valid for: copper cable $\chi = 57 \text{ m}/\Omega\text{mm}^2$, $T_A = 25^\circ\text{C}$ and Pt 100 sensor)

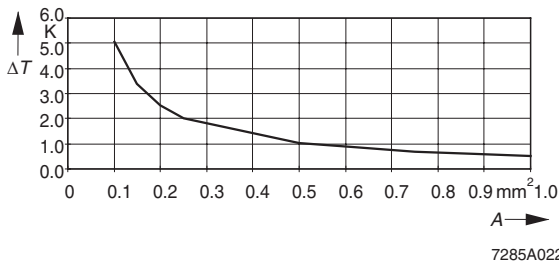

Figure 23 Systematic temperature measuring error ΔT depending on the cable cross section A

(Measuring error valid for: copper cable $\chi = 57 \text{ m}/\Omega\text{mm}^2$, $T_A = 25^\circ\text{C}$, $l = 5 \text{ m}$, and Pt 100 sensor)

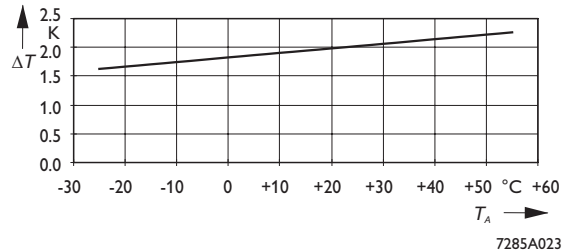

Figure 24 Systematic temperature measuring error ΔT depending on the cable temperature T_A

(Measuring error valid for: copper cable $\chi = 57 \text{ m}/\Omega\text{mm}^2$, $l = 5 \text{ m}$, $A = 0.25 \text{ mm}^2$, and Pt 100 sensor)

All diagrams show that the increase in cable resistance causes the measuring error.

A considerable improvement is made through the use of Pt 1000 sensors. Due to the 10-fold higher temperature coefficient α ($\alpha = 0.385 \text{ } \Omega/\text{K}$ for Pt 100 to $\alpha = 3.85 \text{ } \Omega/\text{K}$ for Pt 1000) the effect of the cable resistance on the measurement is decreased by factor 10. All errors in the diagrams above would be reduced by factor 10.

Figure 22 clearly shows the effect of the cable length on the cable resistance and therefore on the measuring error. The solution is to use the shortest possible sensor cables.

Figure 23 shows the effect of the cable cross section on the cable resistance. Cables with a cross section of less than 0.5 mm^2 cause errors to increase exponentially.

Figure 24 shows the effect of the ambient temperature on the cable resistance. This parameter does not play a great role and can hardly be influenced but it is mentioned here for the sake of completeness.

The formula for calculating the cable resistance is as follows:

$$R_L = R_{L20} \times \left(1 + 0.0043 \frac{1}{K} \times T_A \right)$$

$$R_L = \frac{l}{\chi \times A} \times \left(1 + 0.0043 \frac{1}{K} \times T_A \right)$$

Where:

R_L	Cable resistance in Ω
R_{L20}	Cable resistance at 20°C in Ω
l	Cable length in m
χ	Specific electrical resistance of copper in $\Omega\text{mm}^2/\text{m}$
A	Cable cross section in mm^2
0.0043 1/K	Temperature coefficient for copper
T_A	Ambient temperature (cable temperature) in °C

Since there are two cable resistances in the measuring system (forward and return), the value must be doubled.

The absolute measuring error in Kelvin [K] according to DIN can be obtained for platinum sensors using the average temperature coefficient α ($\alpha = 0.385 \Omega/\text{K}$ for Pt 100; $\alpha = 3.85 \Omega/\text{K}$ for Pt 1000).

© PHOENIX CONTACT 02/2007