

FEATURES

- ◆ Footprint from 0.69cm²
- ◆ I/O isolation voltage 1000VDC
- ◆ Operating Temperature: -40°C ~ +85°C
- ◆ High efficiency up to 80%
- ◆ Fully encapsulated toroidal magnetics
- ◆ Internal SMD construction
- ◆ Power density up to 0.85W/cm³
- ◆ No electrolytic or tantalum capacitors
- ◆ 5V, 9V, 12V and 15V output
- ◆ No heatsink required
- ◆ Dual output from a single input rail
- ◆ UL 94V-0 package material
- ◆ No external components required
- ◆ Industry standard pinout
- ◆ Power sharing on output
- ◆ MTF up to 3.4 million hours

MODEL SELECTION

B^①05^②05^③X^④N2^⑤S^⑥-1W^⑦

- ① Product Series
- ② Input Voltage
- ③ Output Voltage
- ④ Fixed Input
- ⑤ Negation output & pin in the following
- ⑥ SIP Package
- ⑦ Rated Power

APPLICATIONS

The B-XN2S-1W series of DC/DC converters is particularly suited to isolating and/or converting DC power rails. The galvanic isolation allows the device to be configured to provide an isolated negative rail in systems where only positive rails exist. The wide temperature range guarantees startup from -40°C and full 1 watt output at 85°C. For lower ripple, refer to output ripple reduction section.



CE REACH

MICRODC reserves the copyright

SELECTION GUIDE

Order code	Input Voltage (V)	Output Voltage (V)	Output Current (mA)	Input Current (Rated Load) (mA)	Efficiency (%)	Isolation Capacitance (PF)	MTTF ¹ (KHRS)
B0505XN2S-1W	5	5	200	289	69	30	3415
B0509XN2S-1W	5	9	111	260	77	37	3078
B0512XN2S-1W	5	12	83	256	78	33	2205
B0515XN2S-1W	5	15	66	250	80	40	1532
B0524XN2S-1W	5	24	42	248	80	48	900
B1205XN2S-1W	12	5	200	120	69	33	2493
B1209XN2S-1W	12	9	111	116	74	48	2311
B1212XN2S-1W	12	12	83	110	76	55	1780
B1215XN2S-1W	12	15	66	111	75	52	1313
B2405XN2S-1W	24	5	200	60	70	40	201
B2409XN2S-1W	24	9	111	55	75	59	185
B2412XN2S-1W	24	12	83	52	80	78	163
B2415XN2S-1W	24	15	66	52	80	79	136
B4805XN2S-1W	48	5	200	30	70	32	213
B4809XN2S-1W	48	9	111	28	75	50	194
B4812XN2S-1W	48	12	83	26	80	76	164
B4815XN2S-1W	48	15	66	26	80	75	140

1. Calculated using MIL-HDBK-217F with nominal input voltage at full load.

All specifications typical at TA=25°C, nominal input voltage and rated output current unless otherwise specified.

Input Characteristics

Parameter	Conditions	Min.	Typ.	Max.	Units
Voltage range	Continuous operation, 5V input	4.5	5	5.5	VDC
	Continuous operation, 12V input	10.8	12	13.2	VDC
	Continuous operation, 15V input	13.5	15	16.5	VDC
	Continuous operation, 24V input	21.6	24	26.4	VDC
	Continuous operation, 48V input	43.2	48	52.8	VDC
Reflected ripple current			20	40	mA p-p

Absolute Maximum Ratings

Parameter	Conditions
Lead temperature 1.5mm from case for 10 seconds	300°C
Internal power dissipation	700mW
Input voltage V _i , B05 types	7V
Input voltage V _i , B12 types	15V
Input voltage V _i , B15 types	18V
Input voltage V _i , B24 types	28V
Input voltage V _i , B48 types	54V

Output Specifications

Parameter	Conditions	Min.	Typ.	Max.	Units
Rated Power	TA= -40°C to 120°C			1.0	W
Rated Power(B24、 B48)	TA=0°C to 70°C			1.0	W
Voltage Set Point Accuracy	See tolerance envelope				
Line regulation	High VIN to low VIN		1.0	1.2	%%
Line regulation(B24、 B48)	High VIN to low VIN			1.2	%%
Load regulation(B24、 B48)	10% load to rated load, 5V output types			15	%
	10% load to rated load, all other output types			10	%
Load regulation(5Vinput、 12Vinput)	10% load to rated load, 5V output types		10	12.5	%
	10% load to rated load, 9V output types		9	10	%
	10% load to rated load, 12V output types		6.5	7.5	%
	10% load to rated load, 15V output types		6	7.0	%
Load regulation(15V input)	10% load to rated load, 5V output types		5.5	10	%
	10% load to rated load, 12V output types		2.6	3.0	%
	10% load to rated load, 15V output types		2.3	3.0	%
Ripple&Noise(B24、 B48)	BW=DC to 20MHz, all input types			150	mV p-p
Ripple & Noise	BW=DC to 20MHz, 5V output types		10	20	mV p-p
	BW=DC to 20MHz, 9V output types		7	15	mV p-p
	BW=DC to 20MHz, 12V output types		7.5	15	mV p-p
	BW=DC to 20MHz, 15V output types		8	15	mV p-p

Isolation Characteristics

Parameter	Conditions	Min.	Typ.	Max.	Units
Isolation voltage	Flash tested for 1 second	1000			VDC
Resistance	Viso= 1000VDC		10		GΩ
Resistance(B24、 B48)	Viso= 500VDC	10			GΩ

General Characteristics

Parameter	Conditions	Min.	Typ.	Max.	Units
Switching frequency	5V input types		110		kHz
	12V input types		140		kHz
	15V input types		90		kHz
Switching frequency(B24、 B48)	All input types		100		kHz

Temperature Characteristics

Parameter	Conditions	Min.	Typ.	Max.	Units
Specification	B05、 B12、 B15	-40		85	°C
Specification	B24、 B48	0		70	°C
Storage	B05、 B12、 B15	-50		130	°C
Storage	B24、 B48	-55		150	°C
Case temperature rise	0505,1205		33		°C
	0509,0512,0515,1209,1212,1215		28		°C
	1505		26		°C
	1512,1515		17		°C
Cooling	Free air convection				

Temperature derating graph

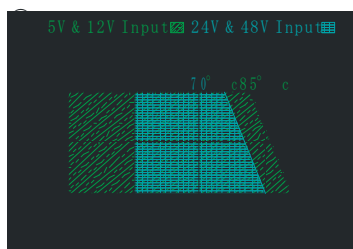
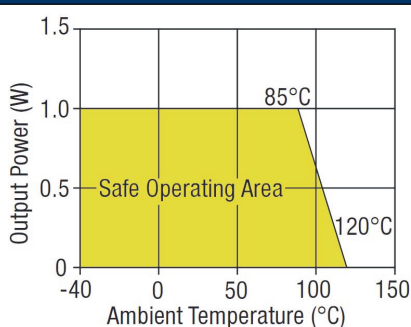

Tolerance envelope

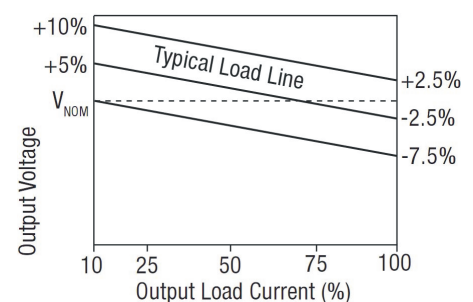

Technical notes

ISOLATION VOLTAGE

"Hi Pot Test", "Flash Tested", "Withstand Voltage", "Dielectric Withstand Voltage" & " Isolation Test Voltage" are all terms that relate to the same thing, a test voltage. Applied for a specified time, across a component designed to provide electrical isolation, to verify the integrity of that isolation. Professional Power Module B series of DC/DC converters are all 100% production tested at their stated isolation voltage. This is 1KVDC for 1 second.

A question commonly asked is, "What is the continuous voltage that can be applied across the part in normal operation?"

For a part holding no specific agency approvals, such as the B series, both input and output should normally be maintained within SELV limits i.e. less than 42.4V peak, or 60VDC. The isolation test voltage represents a measure of immunity to transient voltages and the part should never be used as an element of a safety isolation system. The part could be expected to function correctly with several hundred volts offset applied continuously across the isolation barrier, but then the circuitry on both sides of the barrier must be regarded as operating at an unsafe voltage and further isolation/insulation systems must form a barrier between these circuits and any user-accessible circuitry according to safety standard requirements.

REPEATED HIGH-VOLTAGE ISOLATION TESTING

It is well known that repeated high-voltage isolation testing of a barrier component can actually degrade isolation capability, to a lesser or greater degree depending on materials. Construction and environment. The B series has toroidal isolation transformers, with no additional insulation between primary and secondary windings of enameled wire. While parts can be expected to withstand several times the stated test voltage, the isolation capability does depend on the wire insulation. Any material, including this enamel (typically polyurethane) is susceptible to eventual chemical degradation when subject to very high applied voltages thus implying that the number of tests should be strictly limited. We therefore strongly advise against repeated high voltage isolation testing, but if it is absolutely required, that the voltage be reduced by 20% from specified test voltage.

This consideration equally applies to agency recognized parts for better than functional isolation where the wire enamel insulation is always supplemented by a further insulation system of physical spacing or barriers.

Technical notes

Output ripple reduction

By using the values of inductance and capacitance stated, the output ripple at the rated load is lowered to 5mV p-p max.

Component selection

Capacitor: Ceramic chip capacitors are recommended. It is required that the ESR(Equivalent Series Resistance) should be as low as possible. X7R types are recommended. The voltage rating should be at least twice (except for 15V output), the rated output voltage of the DC/DC converter.

Inductor: The rated current of the inductor should not be less than of the output of the DC/DC converter. At the rated current, the DC resistance of the inductor should be such that the voltage drop across the inductor is <2% of the rated voltage of the DC/DC converter. The SRF(Self Resonant Frequency) should be >20MHz.

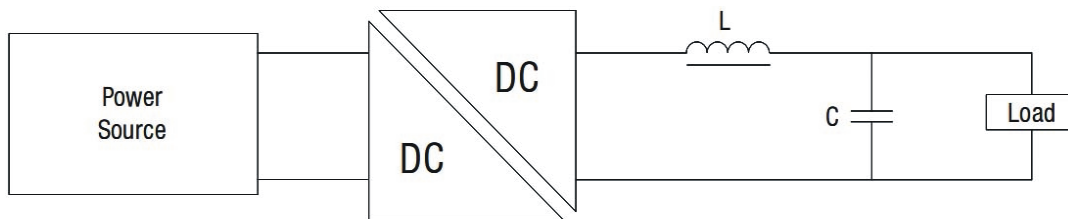

Ripple & Noise Characterisation Method

Ripple and noise measurements are performed with the following test configuration.

C1	1 μ F X7R multilayer ceramic capacitor, voltage rating to be a minimum of 3 times the output voltage of the DC/DC converter
C2	10 μ F tantalum capacitor, voltage rating to be a minimum of 1.5 times the output voltage of the DC/DC converter with an ESR of less than 100m Ω at 100 KHz
C3	100nF multilayer ceramic capacitor, general purpose
R1	450 Ω resistor, carbon film, $\pm 1\%$ tolerance
R2	50 Ω BNC termination
T1	3T of the coax cable through a ferrite toroid
RLOAD	Resistive load to the maximum power rating of the DC/DC converter. Connections should be made via twisted wires
R3	50 Ω resistor, carbon film, $\pm 1\%$

Measured values are multiplied by 10 to obtain the specified values.

Differential Mode Noise Test Schematic

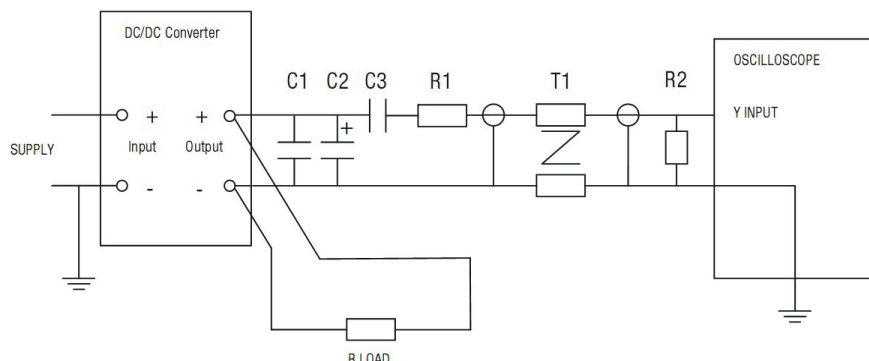

OUTLINE DIMENSIONS & FOOTPRINT DETAILS

MECHANICAL DIMENSIONS

SIP Package

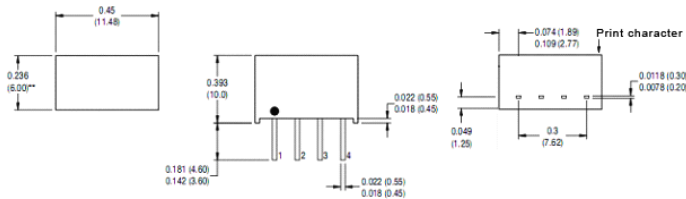

NOTICE: Pin in the following
 All dimensions in inches ± 0.01 (mm ± 0.25 mm). All pins on a 0.1 (2.54) pitch and within ± 0.01 (0.25) of true position.
 Weight: 1.48g (DIP) 1.30g (SIP)

FOOTPRINT DETAILS

-4 PIN SIP

Pin	Function
1	+Vin
2	-Vin
3	+Vout
4	-Vout

Specifications can be changed any time without notice.

No parallel connection or plug and play.

Note:

1. The load shouldn't be less than 10%, otherwise ripple will increase dramatically.
2. Operation under 10% load will not damage the converter; However, they may not meet all specification listed.
3. All specifications measured at $T_a=25^\circ\text{C}$, humidity < 75%, nominal input voltage and rated output load unless otherwise specified.
4. In this datasheet, all the test methods of indications are based on corporate standards.

Recommended footprint details

4 PIN SIP Package

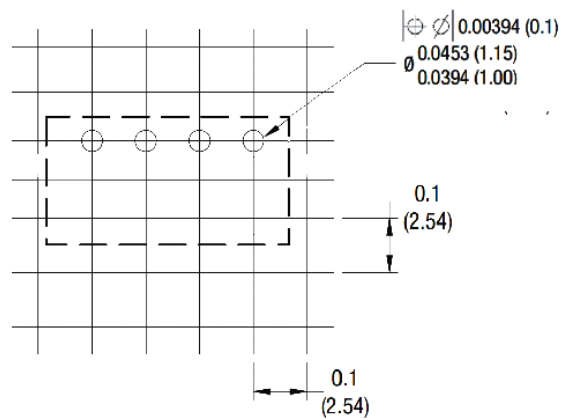

TUBE OUTLINE DIMENSIONS

4 PIN SIP Tube

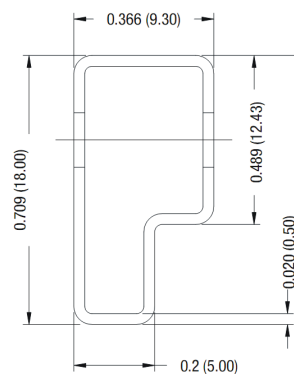

Unless otherwise stated all dimensions in inches (mm) ± 0.5 mm.

Tube length (4 Pin SIP) : 20.47 (520mm ± 2 mm).

Tube Quantity :25

MICRODC

Professional Power Module

Microdc Professional Power Module, Inc.

Tel:0086-20-86000646 E-mail:tech@microdc.cn

Website:http://www.microdc.cn

Microdc Professional Power module, Inc. makes no representation that the use of its products in the circuits described herein, or the use of other technical information contained herein, will not infringe upon existing or future patent rights. Specifications are subject to change without notice.

©2010 Microdc Professional Power Module, Inc. Guangzhou



RoHS COMPLIANT INFORMATION

This series is compatible with RoHS soldering systems with a peak wave solder temperature of 300°C for 10 seconds. The pin termination finish on the SIP package type is Tin Plate, Hot Dipped over Matte Tin with Nickel Preplate. The DIP types are Matte Tin over Nickel Preplate. Both types in this series are backward compatible with Sn/Pb soldering systems.



REACH COMPLIANT INFORMATION

This series has proven that this product does not contain harmful chemicals, it also has harmful chemical substances through the registration, inspection and approval.