

PART NUMBER	RELAY DESCRIPTION
C75-2	SSR with Short Circuit Protection & Terminals for Through Hole Mount
C75-2S	SSR with Short Circuit Protection, Trip Status, & Terminals for Through Hole Mount
C75-2SH	SSR with Short Circuit Protection, Trip Status, Over Voltage Spike Protection Terminals for Through Hole Mount
SC75-2	SSR with Short Circuit Protection & Terminals for Surface Mount
SC75-2S	SSR with Short Circuit Protection, Trip Status, & Terminals for Surface Mount
SC75-2SH	SSR with Short Circuit Protection, Trip Status, Over Voltage Spike Protection. Terminals for Surface Mount

ELECTRICAL SPECIFICATIONS

(-40°C to 85°C UNLESS OTHERWISE SPECIFIED)

INPUT (CONTROL) SPECIFICATIONS

Parameter (see Note 1)	Min	Max	Units
Control Voltage Range	4.5	5.5	Vdc
Input Current @5Vdc (See Figure 1)	12	18	mAdc
Must Turn-On Voltage	4.2		Vdc
Must Turn-Off Voltage		1.5	Vdc

OUTPUT (LOAD) SPECIFICATIONS

Parameter (see Note 1)	Min	Max	Units
Load Voltage Rating		60	Vdc
Transient Blocking Voltage		80	Vdc
Output Current Rating @25°C (See Figure 2)		1.0	Adc
On Resistance (See Figure 3)		0.9	Ohm
Leakage Current at Rated Voltage		100	µAdc
Turn-On Time		2.0	ms
Turn-Off Time		2.0	ms
Input to Output Capacitance @ 1KHz		5	pF
Dielectric Strength	1000		Vac
Insulation Resistance	10 ⁸		Ohm
Junction Temperature		130	°C
Electrical System Spike (see note 8)		±600	VPK

STATUS SPECIFICATIONS

Parameter	Min	Max	Units
Status Leakage Current @ 15Vdc		1	µAdc
Status Blocking Voltage		32	Vdc
Status "On" Voltage @ 10 mAdc		0.4	Vdc
Status "On" Current	10		mAdc



FEATURES/BENEFITS

- Short Circuit Protected: Prevents damage to system components, assemblies and system wiring
- Trip Status: Provides status monitoring and feedback of the protection state
- Optical Isolation: Isolates control circuits from load transients Eliminates ground loops and signal ground noise
- Low Off-State Leakage: For high off-state impedance
- Switches High Currents: To 1.0 Adc
- High Dielectric Strength: For safety and for protection of control and signal level circuits

DESCRIPTION

The C75-2S solid state relay utilizes a power FET switch that is protected against overload and short circuit currents. Protection is provided against turn-on into a short circuit, shorts that occur while conducting loads up to rated or for long term overload currents above rated that slowly overheat the relay. Once the protection trips the relay off it will remain off until reset by cycling the input control. Using the C75-2S to switch power loads can prevent fires, damage to system assemblies and system wiring. The power FET output offers low "On" resistance and can switch loads in either the high or the low side of the power line. The C75-2 is packaged in a 16 pin DIP, with surface mount or through hole mounting available. The C75-2SH also provides an open collector trip status feedback to the relay's control side for short circuit and thermal trip monitoring.

H = Relay has an internal over voltage suppressor for inductive loads.

ELECTRICAL CHARACTERISTICS

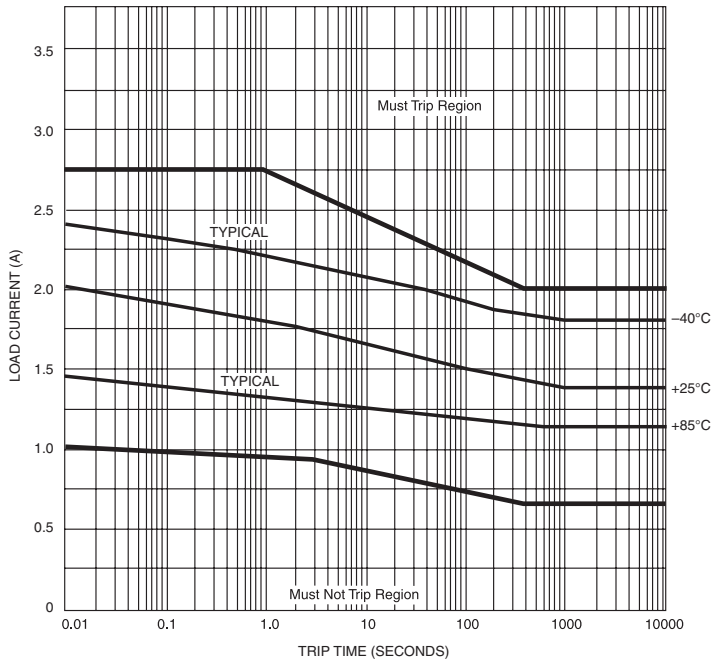

TYPICAL TRIPP CURRENT VS. TIME
FIGURE 4

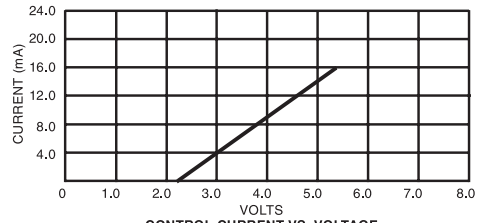

CONTROL CURRENT VS. VOLTAGE
FIGURE 1 (See Note 6)

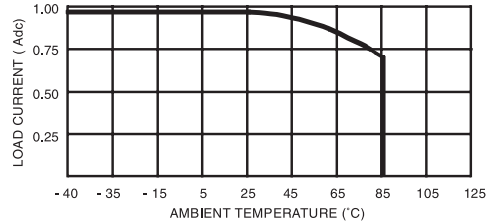

LOAD CURRENT DERATING VS. AMBIENT TEMPERATURE
FIGURE 2 (See Note 5)

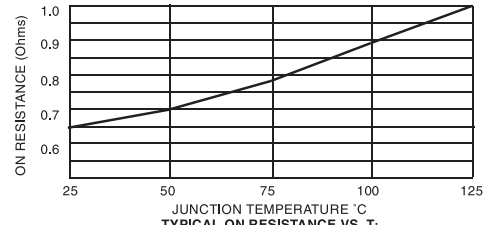

TYPICAL ON RESISTANCE VS. T_j
FIGURE 3

MECHANICAL SPECIFICATION

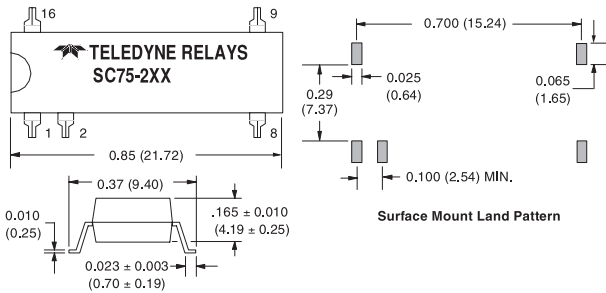

Surface Mount Land Pattern

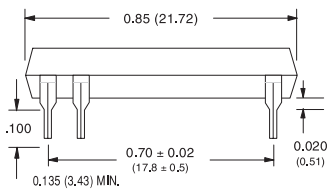
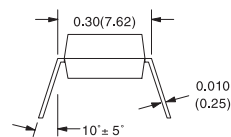
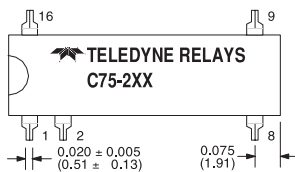

DIMENSIONS ARE IN INCHES (MILLIMETERS)
Tolerances ± 0.015 (0.38) unless specified.

WIRING CONFIGURATIONS

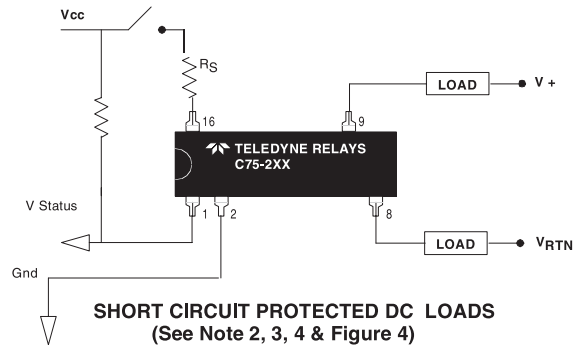

SHORT CIRCUIT PROTECTED DC LOADS
(See Note 2, 3, 4 & Figure 4)

- Operating Temperature Range -40°C to 85°C.
- Storage Temperature Range -40°C to 100°C.
- Weight: 2.0 grams maximum
- Case: 16 pin DIP package
- Case Material: Filled Epoxy, self extinguishing
- Solderability (10 sec) 260°C max

NOTES:

1. The input voltage is 5.0 Vdc for all tests unless otherwise specified.
2. For input voltage greater than 5.5 Vdc, a series resistor must be used to limit the current on the input of the relay. The resistor value shall be selected using the following equation: $R = (V_{in} - 5 \text{ volts}) / 0.015 \text{ A}$
3. Reversing the output polarity when the relay is in overload or is sustaining a short circuit may cause permanent damage.
4. Inductive loads must be diode suppressed.
5. Loads may be switched in either the high side or the low side of the power source.
5. Continuous load current is rated under the conditions of still air and mounted on a printed circuit card
6. To reset a tripped state, remove the overload condition then recycle the input signal
7. Applicable for relays with trip status only. The trip status output is an open collector transistor. Normally this transistor remains off. A trip status Low condition means an output current overload has tripped the relay off.
8. Applicable for over voltage spike protected relays only.