

Radar sensor RAVE-D-NA

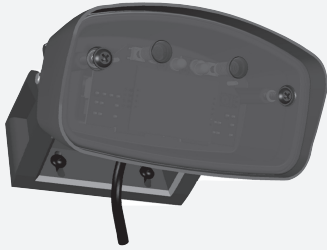
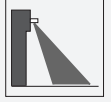

- Degree of protection IP67
- Differentiated detection of people and vehicles, each with one output relay
- Cross-traffic suppression and rotation direction monitoring
- Simplified adjustment options via remote control or integrated push buttons
- Wall and ceiling mountable
- Version with FCC-frequency

Premium industrial door opener with the ability to differentiate between people and vehicles, can be operated remotely, detection range 9 m x 6.5 m, max. installation height 7 m, black housing, 2 relay contact outputs, cable connection

Function

The RAVE-D is a radar sensor for harsh industrial environments. The robust housing with IP67 degree of protection makes it the ideal door opener up to a height of 7 m.

The housing concept enables time-saving mounting due to the convenient wall bracket and locking plate for adjusting the detection field. Differentiated detection of people and vehicles provides targeted door opening. This enables optimized transport routes and energy savings.

Application

- Opening impulse sensor for industrial doors
- Motion sensor for people and objects

Dimensions

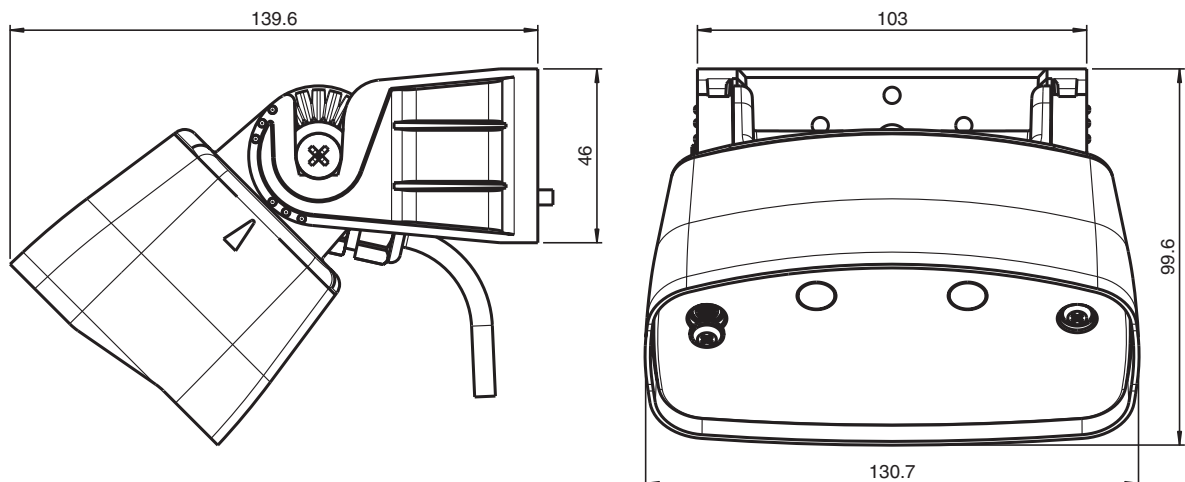

Release date: 2021-07-20 Date of issue: 2021-07-20 Filename: 285648_eng.pdf

Refer to "General Notes Relating to Pepperl+Fuchs Product Information".

Pepperl+Fuchs Group
www.pepperl-fuchs.com

USA: +1 330 486 0001
fa-info@us.pepperl-fuchs.com

Germany: +49 621 776 1111
fa-info@de.pepperl-fuchs.com

Singapore: +65 6779 9091
fa-info@sg.pepperl-fuchs.com

PF PEPPERL+FUCHS

Technical Data

General specifications		
Sensing range	9000 x 6500 mm (d x w) at installation height of 5000 mm and 45° angle 10000 x 5500 mm (d x w) at installation height of 7000 mm and 45° angle	
Function principle	Microwave module	
Detection speed	min. 0.1 m/s	
Marking	FCC	
Setting angle	-90 ... 90 ° in 15 ° increments	
Operating frequency	24.15 ... 24.25 GHz K-Band	
Operating mode	Radar motion sensor	
Transmitter radiated power (EIRP)	< 13 dBm	
Functional safety related parameters		
MTTF _d	620 a	
Mission Time (T _M)	20 a	
Diagnostic Coverage (DC)	0 %	
Indicators/operating means		
Function indicator	LED red/green	
Control elements	Programming push-button for selection of operating modes : Direction detection , Cross traffic suppression , Vehicle detection , Switching type , relay hold up time	
Control elements	Programming via 2 keys , alternative via remote control (Accessories ordered separately)	
Electrical specifications		
Operating voltage	U _B	12 ... 36 V DC , 12 ... 28 V AC
No-load supply current	I ₀	≤ 50 mA at 24 V DC
Power consumption	P ₀	≤ 1 W
Output		
Switching type	NO/NC	
Signal output	2 relay outputs	
Switching voltage	max. 48 V AC / 48 V DC	
Switching current	max. 0.5 A AC / 1 A DC	
Switching power	max. 24 W / 60 VA	
De-energized delay	t _{off}	0.5 ... 300 s adjustable
Approvals and certificates		
FCC approval	FCC Rules part 15 / This device can be used in the USA. RSS-310 of Industry Canada / This device can be used in Canada.	
Approvals	Use in countries within the European Union is not permitted. In other countries, all applicable national regulations must be observed.	
Ambient conditions		
Operating temperature	-30 ... 60 °C (-22 ... 140 °F)	
Storage temperature	-30 ... 60 °C (-22 ... 140 °F)	
Relative humidity	max. 90 % non-condensing	
Mechanical specifications		
Mounting height	2500 ... 7000 mm	
Degree of protection	IP67	
Connection	plug-in screw terminals 4-pin and 2-pin , 8 m connecting cable included with delivery	
Material		
Housing	Polycarbonate (PC) , anthracite	
Mass	650 g	
Dimensions	with Mounting bracket : 131 mm x 73 mm x 136 mm	
Suitable series		
Series	RAVE	

Release date: 2021-07-20 Date of issue: 2021-07-20 Filename: 285648_eng.pdf

Connection Assignment

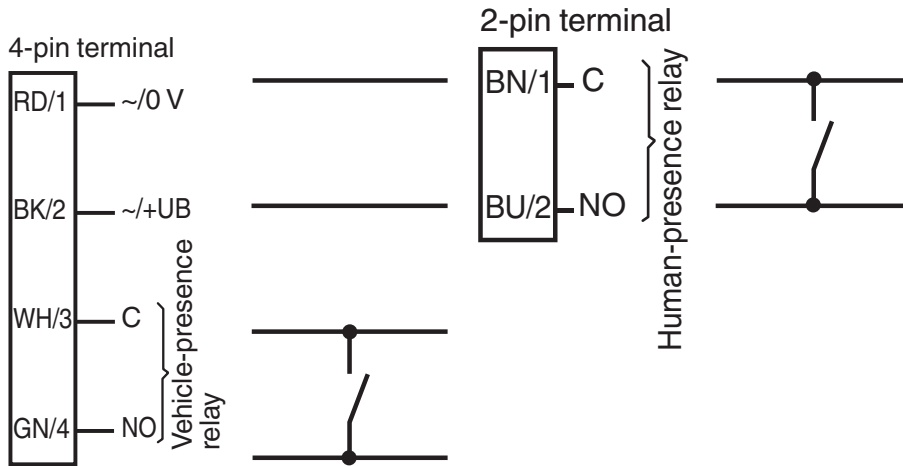

Assembly

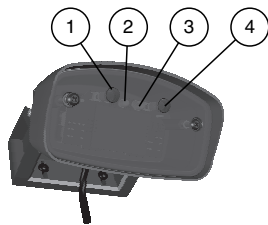

1	"MENU" control button
2	Green status indicator LED
3	Red status indicator LED
4	"VALUE" control button

Application



Function Principle

Microwave sensors are microwave scanners that use the principle of the Doppler radar. The most important requirement for microwave detection is that the object to be detected is moving. The microwave sensors emit microwaves of a defined frequency to detect people and large objects moving at speeds between 100 mm/s and 5 m/s.

The microwaves emitted by the emitter are reflected back from the ground or other surfaces to the receiver. If there is no motion in the monitored zone, the emitted and reflected frequencies are identical. Nothing is detected. If people, animals or objects are moving in the monitored zone, the reflected frequency changes and therefore triggers a detection.



Based on the latest 24 GHz technology with integrated microprocessor control, these sensors provide a high level of reliability, even in difficult operational conditions. The 24 GHz frequency, known as 'K-band,' is reserved by CETECOM for this application area all round the world.

The RAVE series of sensors are equipped with intelligent functions to enable them to be used in a wide variety of applications. The cross-traffic suppression system can be configured so that the door only opens when vehicles or people approach it, while passing pedestrians are ignored. With direction detection, the opening impulse can be triggered based on the direction of motion. Depending on the setting, only movements towards or away from the sensor are detected.

Release date: 2021-07-20 Date of issue: 2021-07-20 Filename: 285648_eng.pdf

Refer to "General Notes Relating to Pepperl+Fuchs Product Information".

Accessories

	<p>RMS Remote Control</p>	<p>Infrared remote control for RMS series and RAVE</p>
	<p>RADAR RC</p>	<p>Infrared remote control for radar sensors</p>

Release date: 2021-07-20 Date of issue: 2021-07-20 Filename: 285648_eng.pdf

Refer to "General Notes Relating to Pepperl+Fuchs Product Information".

Pepperl+Fuchs Group
www.pepperl-fuchs.com

USA: +1 330 486 0001
fa-info@us.pepperl-fuchs.com

Germany: +49 621 776 1111
fa-info@de.pepperl-fuchs.com

Singapore: +65 6779 9091
fa-info@sg.pepperl-fuchs.com

Commissioning

Configuration: Settings

The RAVE sensor is adjusted in programming mode directly on the device using two buttons: --> 8 = button/menu; 7 = button/value. The flashing sequence of the LEDs indicates the settings. With the RMS remote control, available as an accessory, the sensor can be easily and quickly programmed from the ground. The bidirectional infrared remote control with an LCD display and self-explanatory menu interface has a range of 10 m. Even sensors with considerable installation heights can be precisely and easily adjusted.

Model number for remote control: RMS remote control

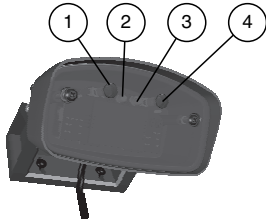

1	"MENU" control button
2	Green status indicator LED
3	Red status indicator LED
4	"VALUE" control button

The following properties are adjustable:

Dimensions of the detection area

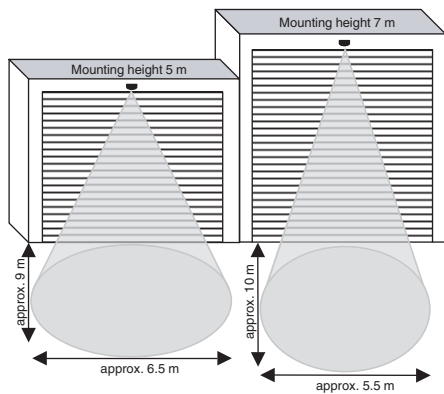

At maximum sensitivity and angle of incidence

Dimensions of the detection area

The size of the sensing area can be changed by adjusting the sensitivity using the buttons or remote control.



High sensitivity = Large area

Low sensitivity = small area

Position of the sensing area

Snap-in positions are provided every 15 degrees to allow the sensor to be tilted depending on requirements.

To adjust the tilt angle, loosen the long screw, move the sensor into the required position (the sensor will snap into place) and tighten the long screw again.

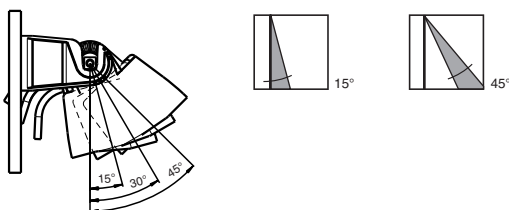

Inclined detection area

Release date: 2021-07-20 Date of issue: 2021-07-20 Filename: 285648_eng.pdf

Refer to "General Notes Relating to Pepperl+Fuchs Product Information".

Installing the mounting bracket on an incline has the following effects on the detection field:

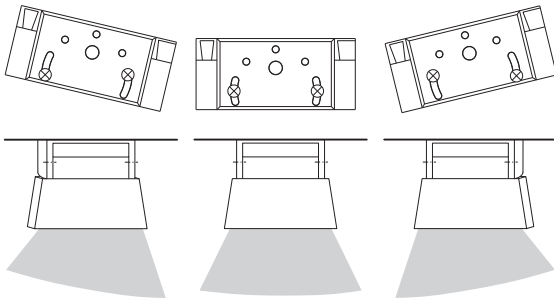

Detection without rotation direction monitoring

Forward/backward

Detection with rotation direction monitoring

Forward (toward the sensor)

Backward (away from the sensor)

Cross-traffic suppression

Without suppression: door opens even in the event of cross-traffic

With suppression: door remains closed in the event of cross-traffic

Detection of people/vehicles

The sensor evaluates movements of people and vehicles in different ways and switches the vehicle relay or the person relay according to the setting.

The ability to distinguish between people/vehicles makes it possible to open the door only for vehicles. Approaching people must use the side entry.

Indication

LED	Status
Red/green flashing	Sensor initialization in progress
Green	Sensor ready for operation, no detection
Flashing green 3x	Command received from remote control
Flashing red in quick succession	Vehicle-presence relay active
Flashing green in quick succession	Human-presence relay active
Flashing red/green in quick succession	Vehicle-presence relay and human-presence relay both active

**Application examples:
Distinguishes between people and vehicles**

Example 1: Vehicle recognition at a door

Door controller with one switch input.

Output function for vehicle-presence relay "Vehicle forward".

Vehicle approaches:	Vehicle-presence relay is activated. The door opens.
Person approaches:	Vehicle-presence relay is not activated. Door remains closed

Release date: 2021-07-20 Date of issue: 2021-07-20 Filename: 285648_eng.pdf

Refer to "General Notes Relating to Pepperl+Fuchs Product Information".

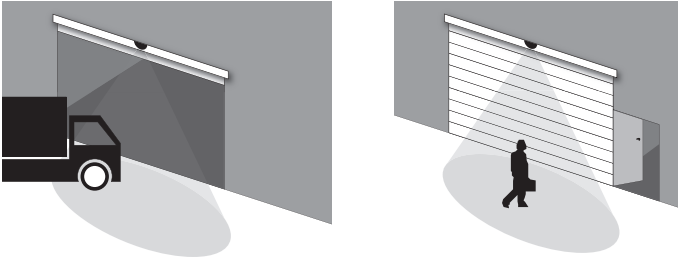

Example 2: Door with vehicle recognition and separate entrance for people

Door control with two switching inputs (vehicle-presence relay and human-presence relay).

Output function for vehicle-presence relay "Vehicle forward". Output function for human-presence relay "Person forward". Relay configuration as per factory settings.*

- Person approaches: Vehicle-presence relay is not activated. Door remains closed. Human-presence relay is activated. Entrance for people opens.
- Vehicle approaches: Vehicle-presence relay is activated. The door opens. Human-presence relay is not activated. Entrance for people remains closed.

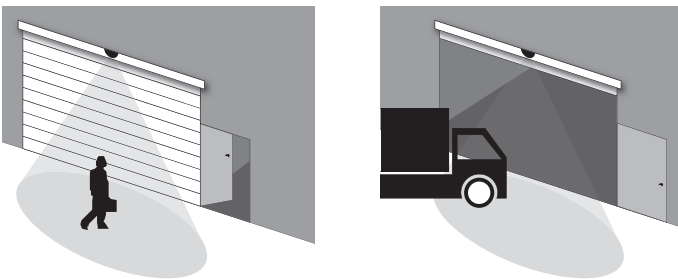

Example 3: Door with vehicle recognition without separate entrance for people

Door control with two switching inputs (vehicle-presence relay and human-presence relay).

Output function for vehicle-presence relay "Vehicle forward". Output function for human-presence relay "Person forward". Relay configuration as per factory settings.*

- Person approaches: Vehicle-presence relay is not activated. No action. Human-presence relay is activated. The door opens half-way.
- Vehicle approaches: Vehicle-presence relay is activated. The door opens fully. Human-presence relay is not activated. No action.

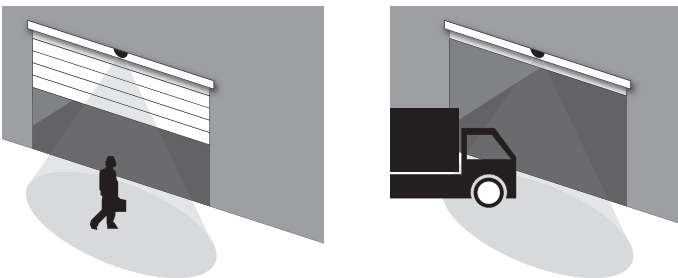

*) Vehicles crossing the detection range of the sensor may cause the human-presence relay to be activated unexpectedly.

Release date: 2021-07-20 Date of issue: 2021-07-20 Filename: 285648_eng.pdf