

# HRF-SW1030

## SP6T Absorptive RF Switch DC to 2.5GHz Operation

The Honeywell HRF-SW1030 is a high performance single pole six throw (SP6T) absorptive RF switch ideal for use in wireless basestation and handset applications that require minimum power and minimum insertion loss.

The HRF-SW1030 is manufactured with Honeywell's patented Silicon On Insulator (SOI) CMOS technology, which provides the performance of GaAs with the economy and integration capabilities of conventional CMOS technology. These switches are DC coupled to improve lower operating frequency, frequency response and reduce the number of DC bias points required.

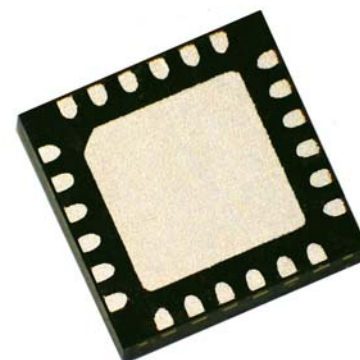

HRF-SW1030 in VQFN Package

### FEATURES

- Typical High Isolation Of > 42 dB @ 2 GHz
- Typical Low Insertion Loss Of 1.6 dB @ 1 GHz
- Integrated CMOS Control Logic
- DC-coupled, bi-directional RF Path
- Single Positive Supply Voltage
- Ultra Small VQFN Packaging
- Impedance matched for 50 Ohm systems
- Lead-free, RoHS compliant and Green

### RF ELECTRICAL SPECIFICATIONS @ + 25°C

Results @  $V_{DD} = 5.0 \pm 10\%$ ,  $V_{SS} = 0$  unless otherwise stated,  $Z_0 = 50$  Ohms  
Contact Honeywell for relative performance at other supply configurations

Parameter	Test Condition	Frequency	Minimum	Typical	Maximum	Units
Insertion Loss		1.0 GHz		1.6	2.5	dB
		2.0 GHz		2.1	3.3	dB
		2.5 GHz		2.4	3.8	dB
Isolation		1.0 GHz	36	50		dB
		2.0 GHz	30	42		dB
		3.0 GHz	27	40		dB
Return Loss			-10	-15		dB
Input P1dB	$V_{SS} = \text{Gnd}$ $V_{SS} = -5V$	1.0 GHz		16		dBm
		1.0 GHz		25		dBm
Input IP3	Two-Tone Inputs, + 5 dBm $V_{SS} = \text{Gnd}$ $V_{SS} = -5V$	2.0 GHz		33		dBm
		2.0 GHz		35		dBm
Trise, Tfall Ton, Toff	10% To 90% 50% Cntl To 90% / 10% RF			10		ns
				20		ns

# HRF-SW1030

## DC ELECTRICAL SPECIFICATIONS @ + 25°C

Parameter	Minimum	Typical	Maximum	Units
V <sub>DD</sub>	3.3 <sup>1</sup>	5.0	5.5	V
V <sub>SS</sub>	-5.0			V
I <sub>DD</sub>		<5	35	uA
CMOS Logic Level (0)	0		0.8	V
CMOS Logic Level (1)	V <sub>DD</sub> - 0.8		V <sub>DD</sub>	V
Input Leakage Current			10	uA

Note 1 - Performance curves are for VDD = +5.0 +/- 10%

## ABSOLUTE MAXIMUM RATINGS<sup>1</sup>

Parameter	Absolute Maximum	Units
V <sub>DD</sub>	+6.0	V
V <sub>SS</sub>	-5.5	V
Vin Digital Logic 0	-0.6	V
Vin Digital Logic 1	V <sub>DD</sub> + 0.6	V
Input Power	> 35	dBm
ESD Voltage <sup>2</sup>	400	V
Moisture Sensitivity Level	Level 3 @ 260°C	
Operating Temperature Range	-40 to +85	°C
Storage Temperature Range	-65 to +125	°C

Note 1 - Operation of this device beyond any of these parameters may cause permanent damage.

Note 2 - Although the HRF-SW1030 contains ESD protection circuitry on all digital inputs, precautions should be taken to ensure that the Absolute Maximum Ratings are not exceeded.

**Latch-Up:** Unlike conventional CMOS digital switches, Honeywell's HRF-SW1030 is immune to latch-up.

## TRUTH TABLE

C2	C1	C0	RF Output 1	RF Output 2	RF Output 3	RF Output 4	RF Output 5	RF Output 6
0	0	1	RFINPUT					
0	1	0		RFINPUT				
0	1	1			RFINPUT			
1	0	0				RFINPUT		
1	0	1					RFINPUT	
1	1	0						RFINPUT

"0" = CMOS Low, "1" = CMOS High

Note: For codes 000 and 111 all outputs are in the terminated isolation state.

## PIN CONFIGURATIONS

Pin	Function	Pin	Function	Pin	Function	Pin	Function
1	GROUND	7	VDD	13	GROUND	19	GROUND
2	GROUND	8	C2	14	GROUND	20	GROUND
3	RFOUTPUT5	9	C1	15	RFOUTPUT2	21	RFINPUT
4	GROUND	10	C0	16	GROUND	22	GROUND
5	GROUND	11	VSS	17	GROUND	23	GROUND
6	RFOUTPUT4	12	RFOUTPUT3	18	RFOUTPUT1	24	RFOUTPUT6

**Note:** Bottom ground plate must be grounded for proper RF performance.

# HRF-SW1030

## PERFORMANCE CURVES

### Insertion Loss

Typical SW1030 Insertion Loss

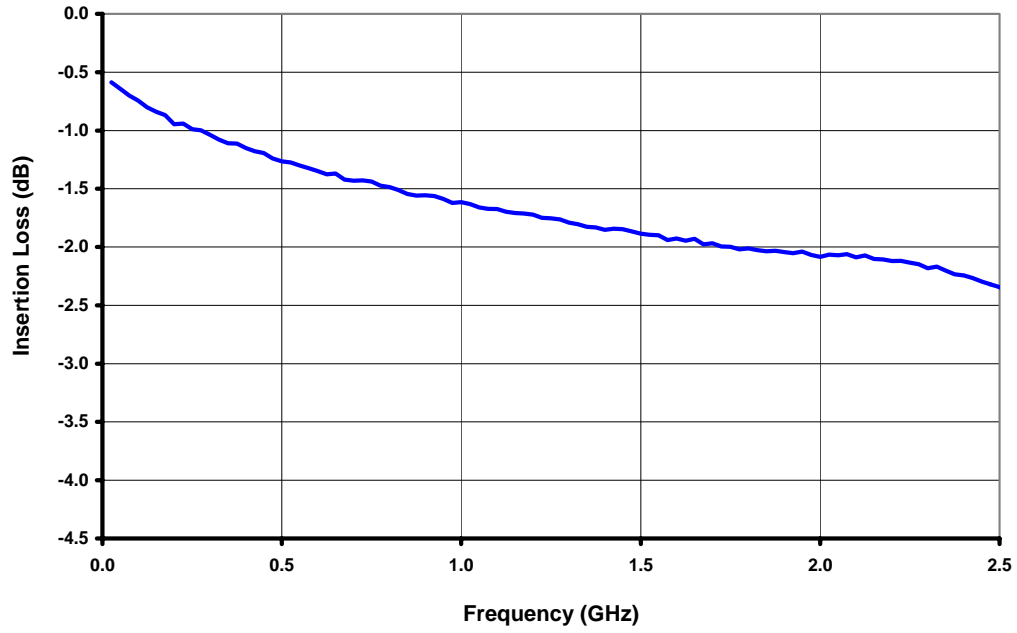

### Isolation

Typical SW1030 Isolation

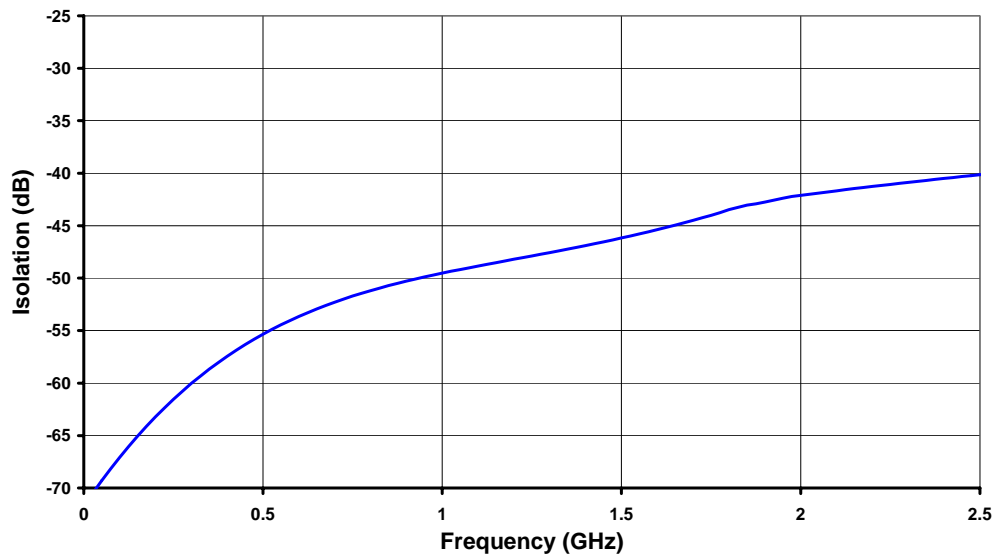

# HRF-SW1030

## PACKAGE OUTLINE DRAWING

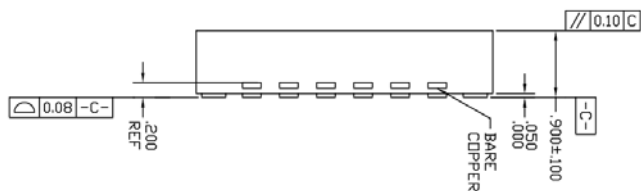
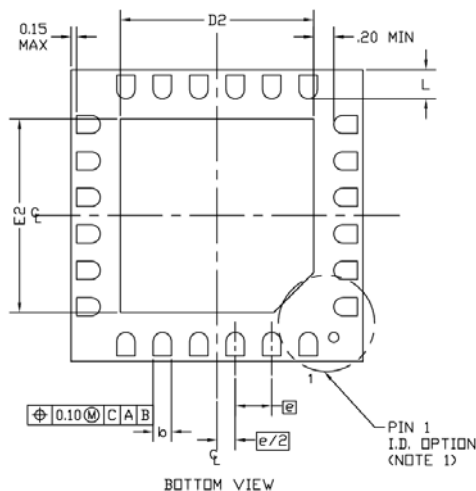
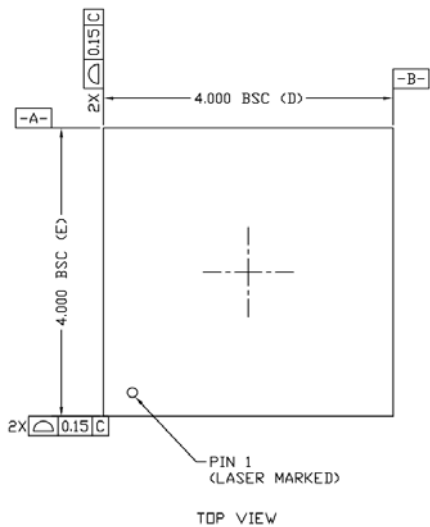

SYMBOL	MIN	NOM	MAX
e	0.50 BSC		
b	0.18	0.25	0.30
E2	2.55	2.65	2.75
D2	2.55	2.65	2.75
L	0.35	0.40	0.45
INTERNAL FEATURE	FUSE LEAD		

### Notes

1. Pin 1 identifier can be a combination of a dot and/or chamfer.
2. Dimensions are in millimeters.

## GREEN MATERIAL SET

The -GR switches have a Green material set that can withstand a maximum soldering temperature of 260°C.

## LEAD FINISH

The package leads are Nickel Palladium Gold (NiPdAu). The configuration being manufactured and delivered today is lead-free RoHS compliant. Compliant packages have half-etch leadframes and have date codes of 0300 or greater.

## LEAD FREE QFN SURFACE MOUNT APPLICATION

Please see Application Note AN310 for assembly process recommendations. The maximum soldering temperature of the -GR is 260°C (-AU switches are 250°C). Application Notes can be found at our website: [www.honeywell.com/microwave](http://www.honeywell.com/microwave)

## CIRCUIT APPLICATION INFORMATION

These switches require a DC reference to ground. They may not operate properly when AC coupled on both the RF input and output without a DC ground reference provided as part of the circuit. See Application Note AN311.

# HRF-SW1030

## EVALUATION CIRCUIT BOARD

Honeywell's evaluation board provides an easy to use method of evaluating the RF performance of our switch. Simply connect power; DC and RF signals to be measuring switch performance in less than 10 minutes.

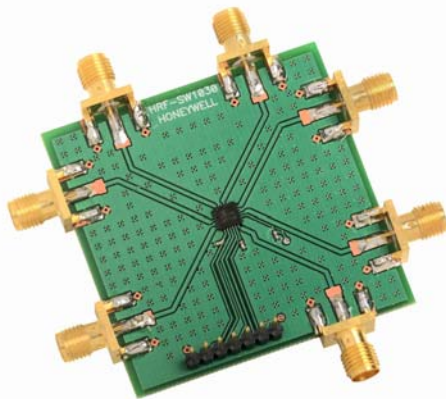

HRF-SW1030 Evaluation Board

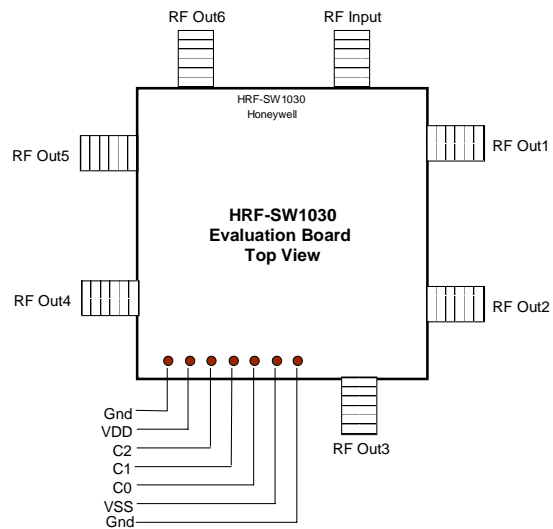

## EVALUATION CIRCUIT BOARD LAYOUT DESIGN DETAILS

Item	Description
PCB	Impedance Matched Multi-Layer FR4
Attenuator	HRF-SW1030 Digital Attenuator
Chip Capacitor	Panasonic Model ECU-E1C103KBQ Capacitor, .01uf 0402 10% 16V
RF Connector	Johnson Connectors Model 142-0701-801 SMA RF Coaxial Connector
DC Pin	Mil-Max Model 800-10-064-10-001 Header Pins

## ORDERING INFORMATION

Ordering Number	Delivery Method	Units Per Shipment
HRF-SW1030-GR-TR	Tape & Reel	2500 Units per Reel
HRF-SW1030-GR-T	Tape	< 2500
HRF-SW1030-E	Evaluation Board	One Board Per Box

The new –GR switches will replace and are fully back-compatible with the –AU switches. The –AU switches are obsolete.

## FIND OUT MORE

For more information on Honeywell's Microwave Products visit us online at [www.honeywell.com/microwave](http://www.honeywell.com/microwave) or contact us at 800-323-8295 (763-954-2474 internationally).

Honeywell reserves the right to make changes to improve reliability, function or design. Honeywell does not assume any liability arising out of the application or use of any product or circuit described herein; neither does it convey any license under its patent rights nor the rights of others.