

SPECIFICATION

- Part No. : **WCM.01.0151W**
- Product Name: : 2.4GHz Button Antenna
- Features : Smallest External Wi-Fi/Bluetooth Antenna
2dBi~5dBi Peak Gain
Dims: 19.8*14.3*16.4mm
2400MHz to 2500MHz Antenna
Wi-Fi/Bluetooth
60%+ Efficiency
RP SMA(M) Connector
IP67 Housing
Omnidirectional
ROHS Compliant
*Gain varies depending on ground-plane size



1. Introduction

The WCM.01w 2.4GHz antenna is the smallest RP-SMA(M) external antenna in the market, fitting into spaces other traditional monopole, dipole or rubber ducky antenna cannot go. A unique PIFA design ensures omnidirectional gain across 2.4GHz to 2.5GHz ensuring constant reception and transmission to make it a great antenna for 2.4GHz Wi-Fi and Bluetooth applications.

This antenna features greater than 60% efficiency when connected directly to the ground plane of the device.

Typical Applications

- Application Points
- Routers
- IoT M2M devices
- Smart Home applications

This antenna comes with an RP SMA(M) to be compatible with most Wi-Fi applications and routers in the market. The WCM.01 antenna housing is also IP67 water resistant. The antenna should be mounted on the edge of the main PCB ground-plane of the device. Due to its monopole design, relatively larger ground-planes will increase the efficiency and peak gain of the antenna.

The ideal position for the antenna to radiate is mounted clear of metal housings. Connector is customizable subject to minimum order quantities and possible NRE.

Contact your Taoglas regional sales office for more information.

2. Specification

ELECTRICAL				
Frequency (MHz)		2400	2450	2500
Efficiency (%)				
In free space		33.30	30.36	29.65
On the 10*10cm	Ground plane(center edge)	63.43	71.44	66.85
On the 10*10cm	Ground plane(off center edge)	55.85	68.43	61.73
On the 20*20cm	Ground plane(center edge)	64.20	71.40	63.97
On the 20*20cm	Ground plane(off center edge)	62.55	81.30	69.73
On the 30*30cm	Ground plane(center edge)	58.31	70.49	60.87
On the 30*30cm	Ground plane(off center edge)	62.11	73.46	61.90
Average Gain (dBi)				
In free space		-4.78	-5.18	-5.28
On the 10*10cm	Ground plane(center edge)	-1.98	-1.46	-1.75
On the 10*10cm	Ground plane(off center edge)	-2.53	-1.65	-2.10
On the 20*20cm	Ground plane(center)	-1.92	-1.46	-1.94
On the 20*20cm	Ground plane(off center edge)	-2.04	-0.90	-1.57
On the 30*30cm	Ground plane(center edge)	-2.34	-1.52	-2.16
On the 30*30cm	Ground plane(off center edge)	-2.07	-1.34	-2.08
Peak Gain (dBi)				
In free space		0.89	0.40	0.12
On the 10*10cm	Ground plane(center edge)	2.02	2.45	2.37
On the 10*10cm	Ground plane(off center edge)	3.46	4.09	3.47
On the 20*20cm	Ground plane(center edge)	4.26	4.54	3.69
On the 20*20cm	Ground plane(off center edge)	4.02	5.40	4.65
On the 30*30cm	Ground plane(center edge)	3.64	4.85	4.06
On the 30*30cm	Ground plane(off center edge)	3.79	4.23	3.15
Radiation	Omnidirectional			
Polarization	Linear			
Impedance	50Ω			
Max Input Power	10W			
MECHANICAL				
Antenna Dimension	19.8*14.3*16.4mm			
Casing	ABS			
Connector	RP-SMA(M)			
Weight	6g			
Ingress Protection Rating	IP67 (Housing only)			

ENVIRONMENTAL	
Operation Temperature	-40°C ~ + 85°C
Storage Temperature	-40°C ~ + 85°C
Humidity	Non-condensing 65°C 95% RH

3. Antenna Characteristics

3.1 Testing Setup

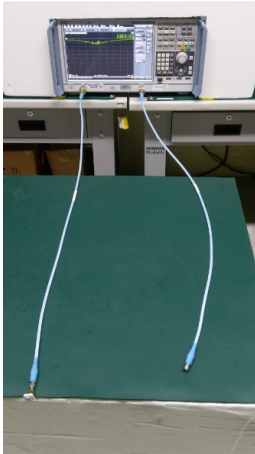

a) In free space

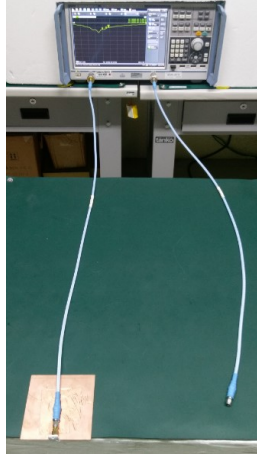

b) With 10*10cm ground plane center edge

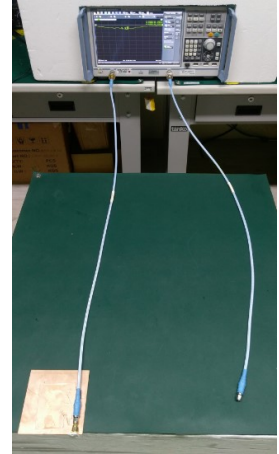

c) With 10*10cm ground plane off center edge

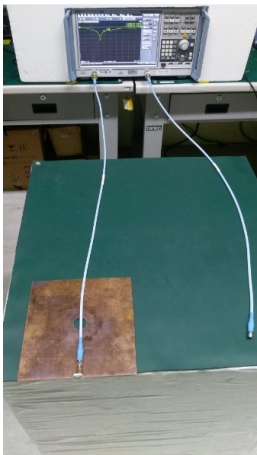

d) With 20*20cm ground plane center edge

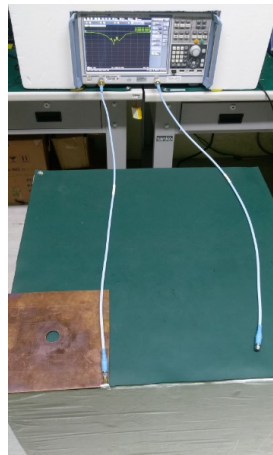

e) With 20*20cm ground plane off center edge

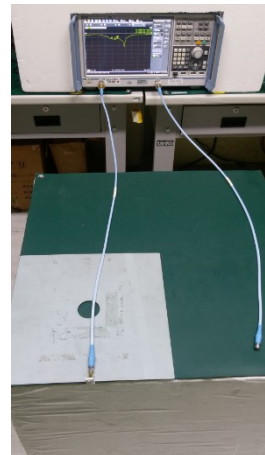

f) With 30*30cm ground plane center edge

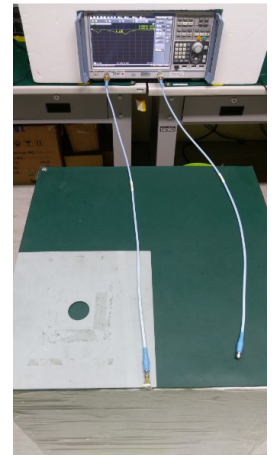

g) With 30*30cm ground plane off center edge

Figure.1 Antenna Measurement Setup

3.2 Return Loss (In free space)

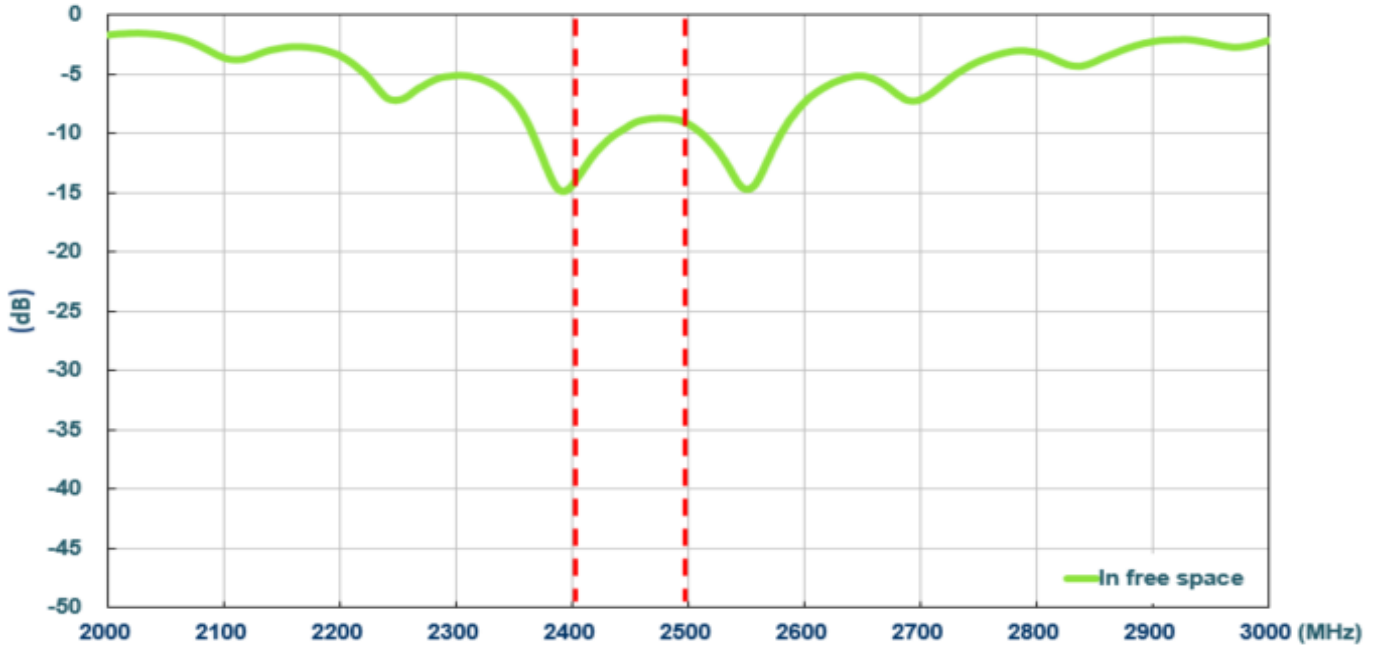

Figure 2. Return loss of WCM.01 antenna

3.3 Return Loss(On ground plane center edge)

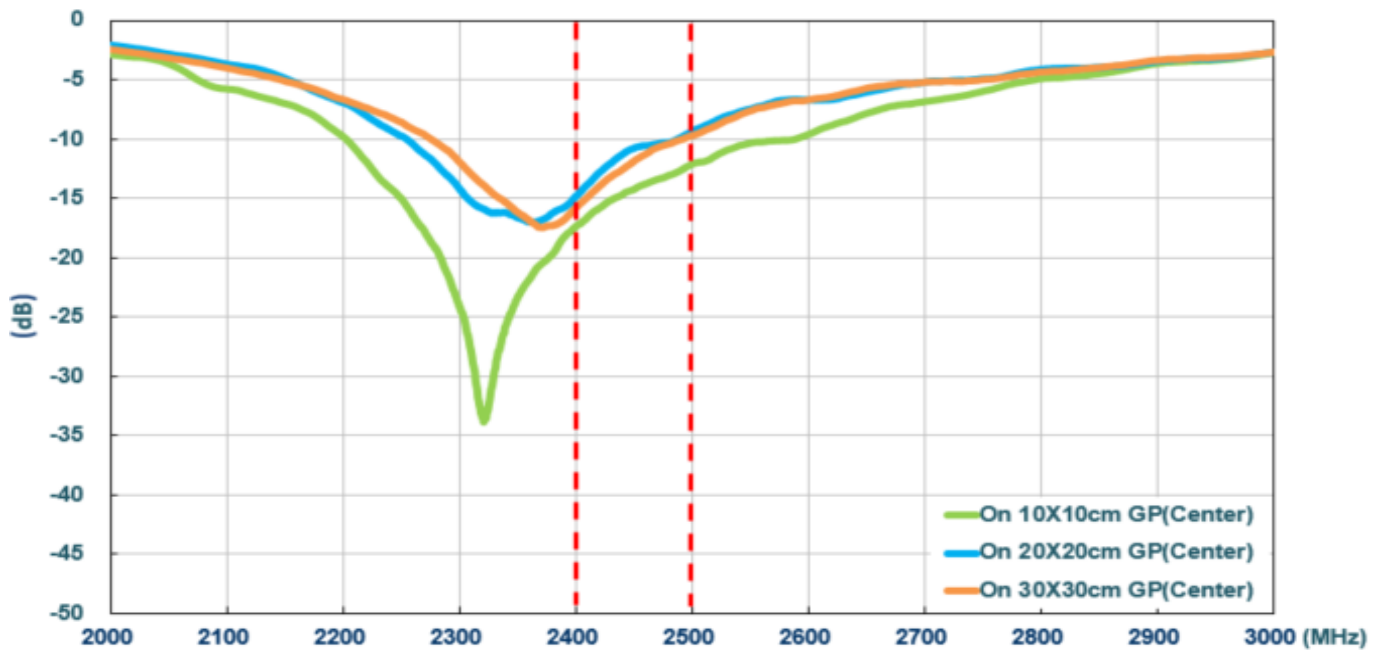

Figure 3. Return loss of WCM.01 antenna with different ground plane size

3.4 Return Loss (On ground plane off center edge)

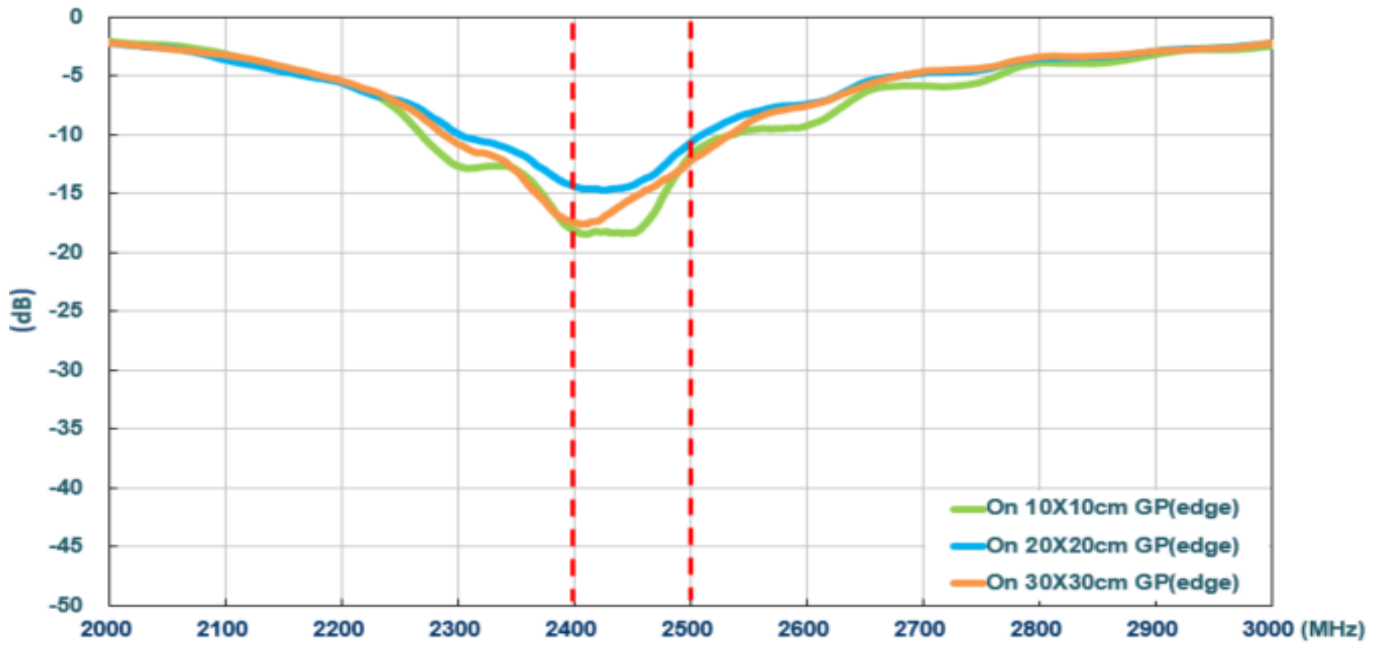

Figure 4. Return loss of WCM.01 antenna with different ground plane size

3.5 Efficiency (In free space)

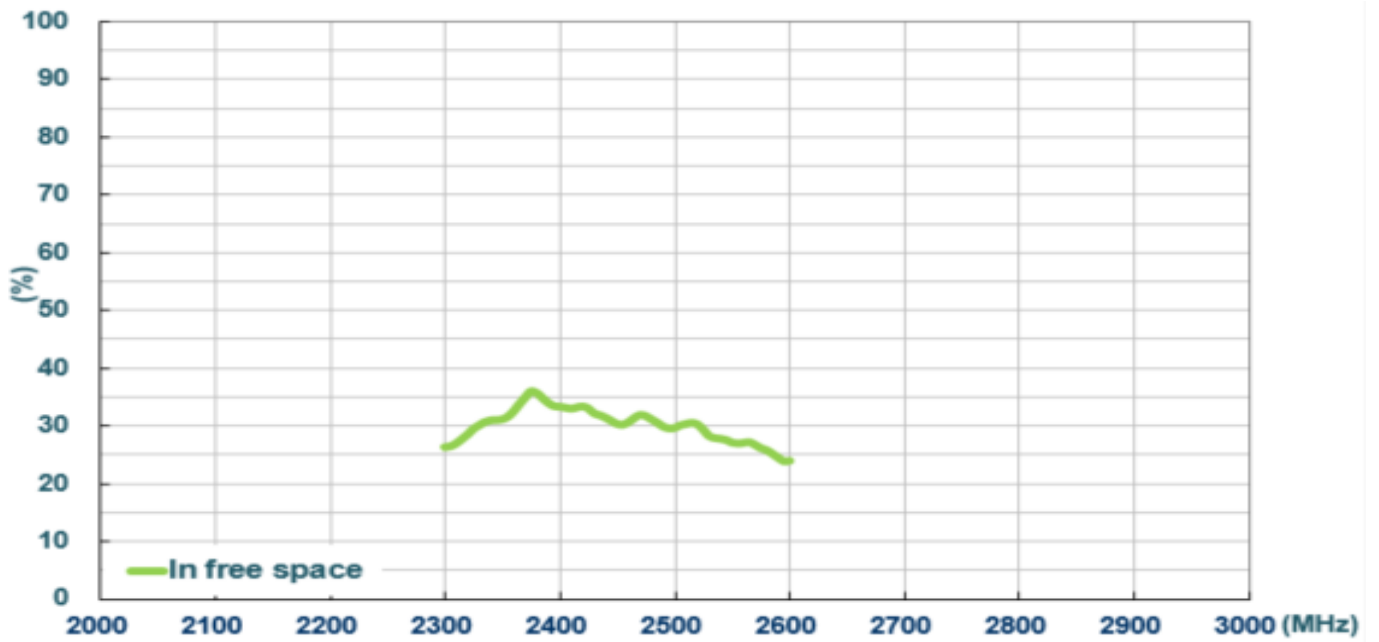

Figure 5. Efficiency of WCM.01 antenna

3.6 Efficiency (On ground plane center edge)

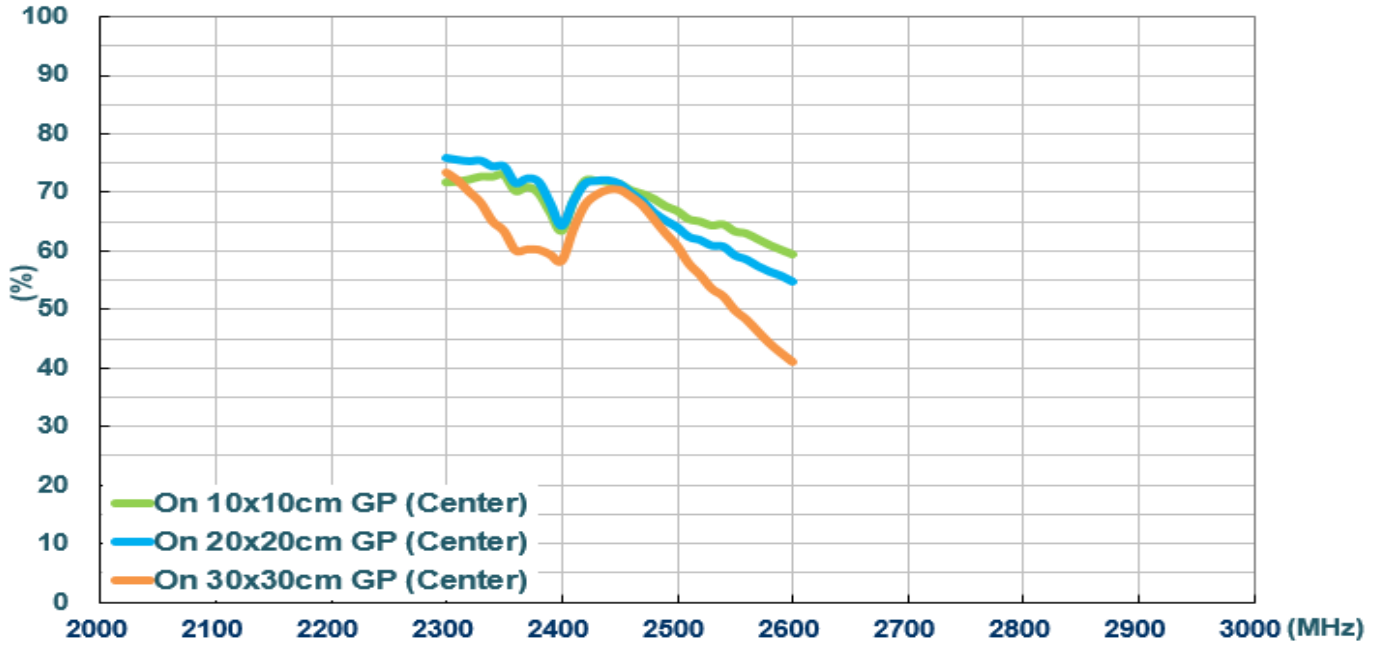

Figure 6. Return loss of WCM.01 antenna with different ground plane size

3.7 Efficiency (On ground plane off center edge)

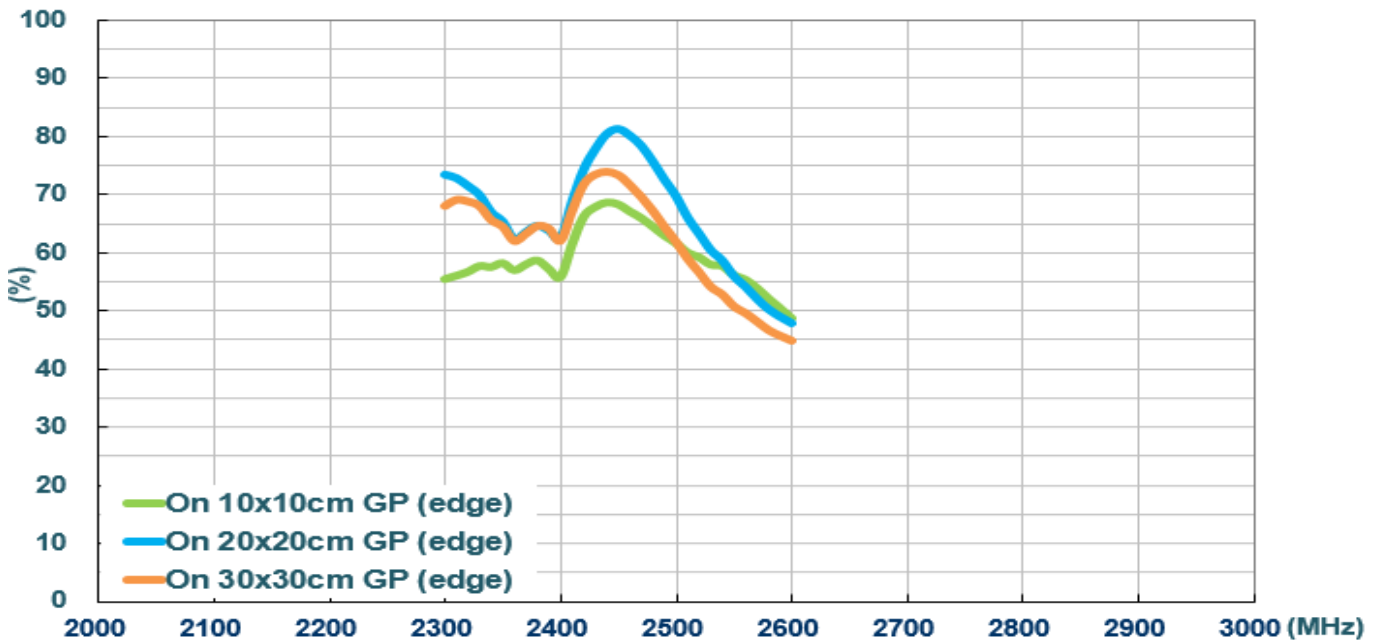

Figure 7. Return loss of WCM.01 antenna with different ground plane size

3.8 Peak Gain (In free space)

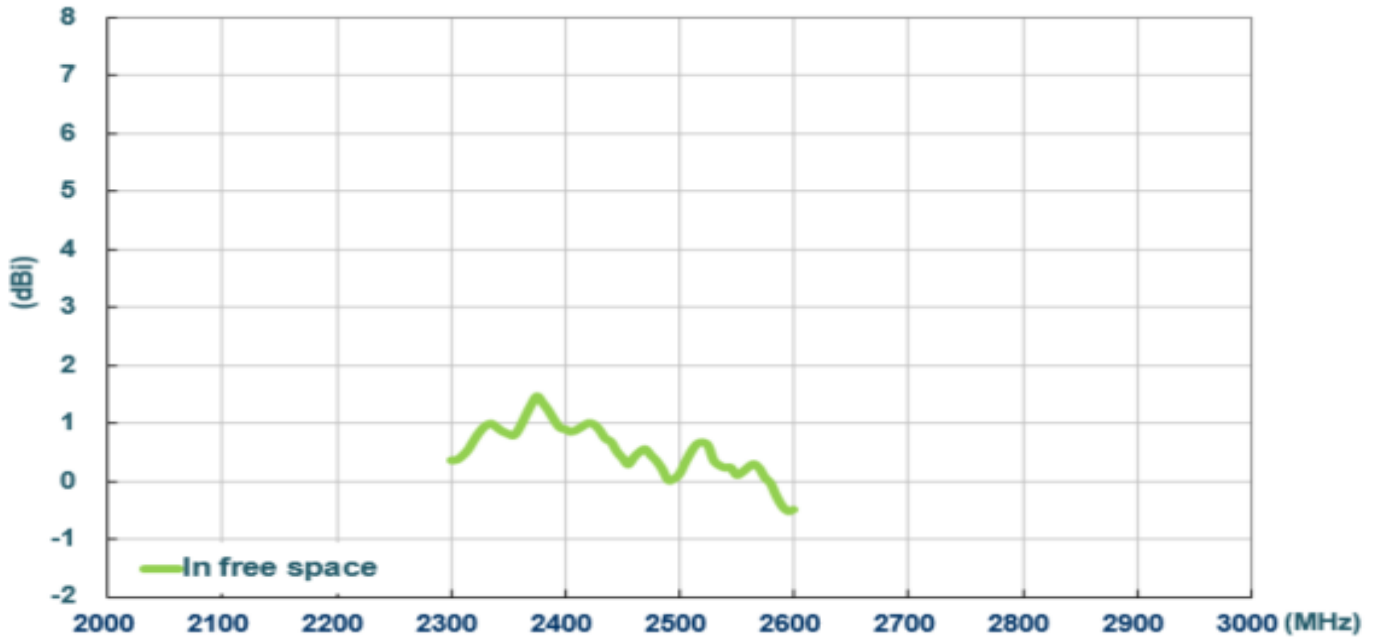

Figure 8. Peak gain of WCM.01 antenna with different ground plane size

3.9 Peak Gain (On ground plane center edge)

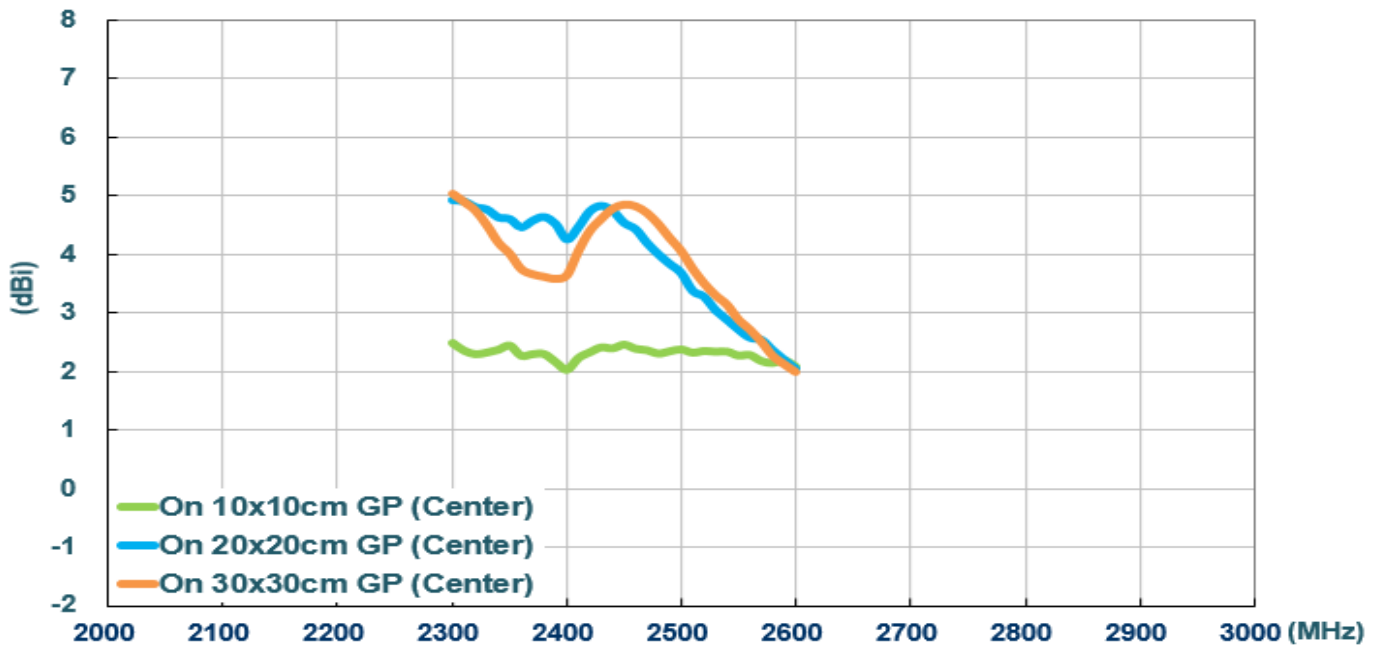

Figure 9. Peak gain of WCM.01 antenna with different ground plane size

3.10 Peak Gain (On ground plane off center edge)

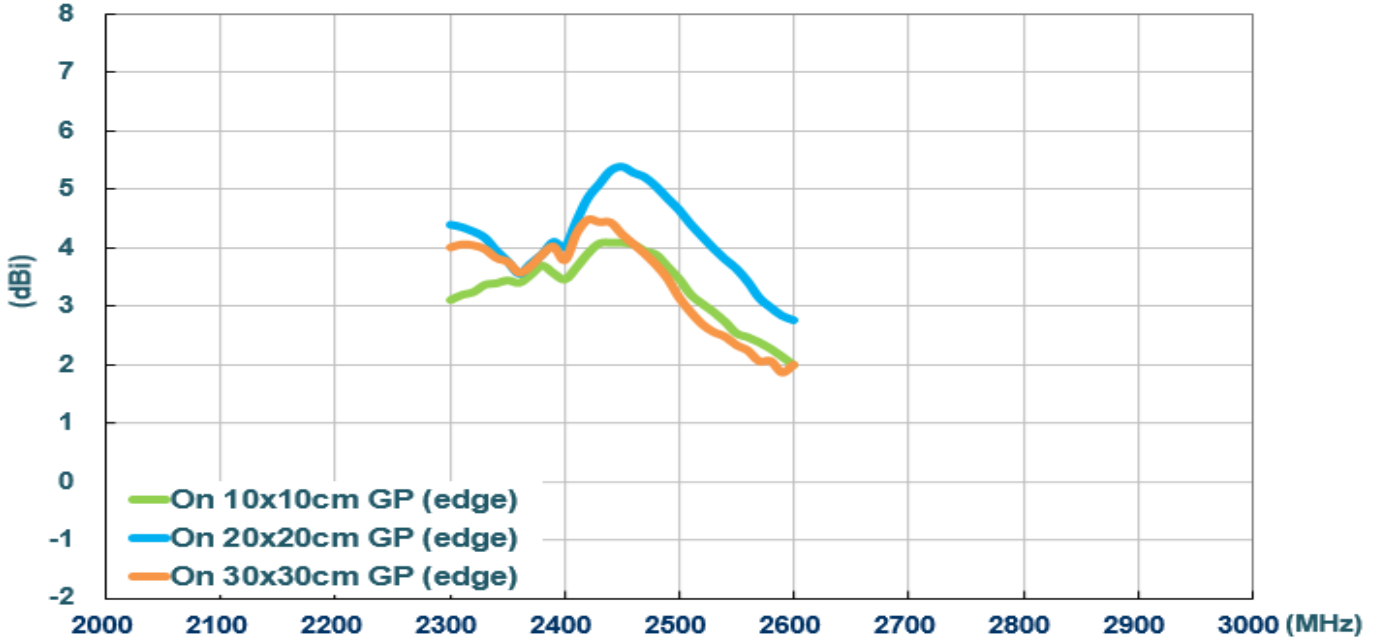

Figure 10. Peak gain of WCM.01 antenna with different ground plane size

3.11 Average Gain (In free space)

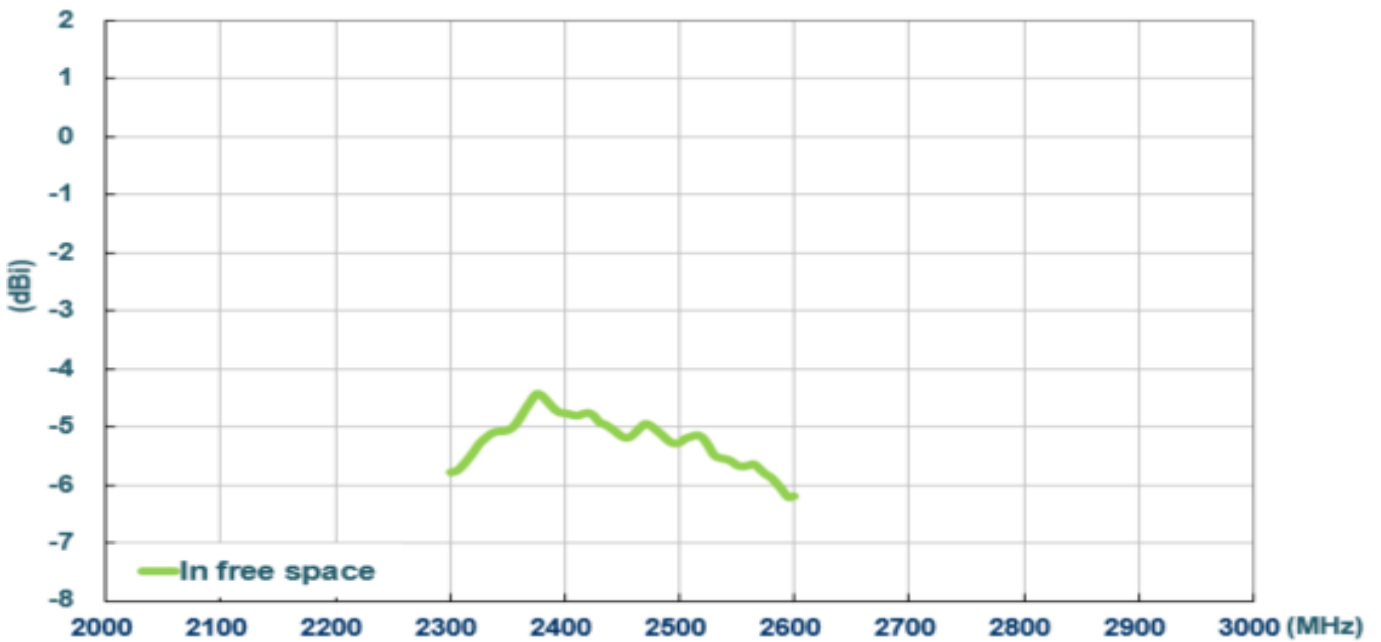

Figure 11. Average gain of WCM.01

3.12 Average Gain (On ground plane center edge)

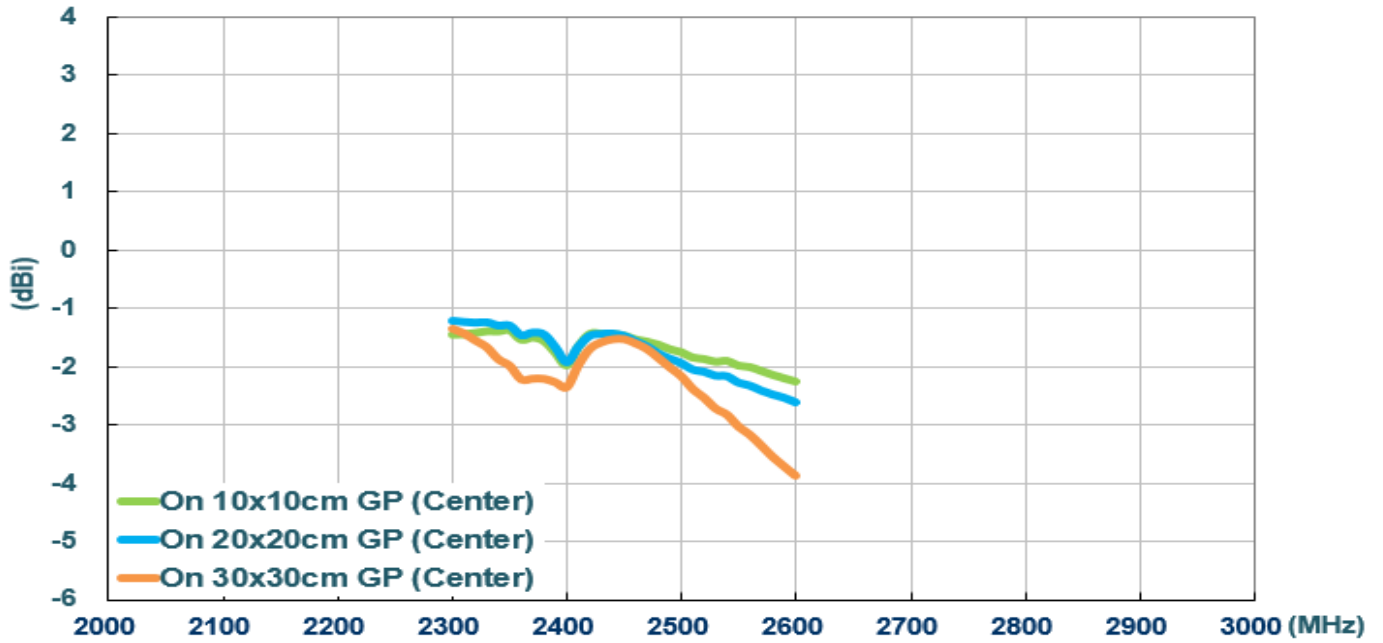

Figure 12. Average gain of WCM.01 antenna with different ground plane size

3.13 Average Gain (On ground plane off center edge)

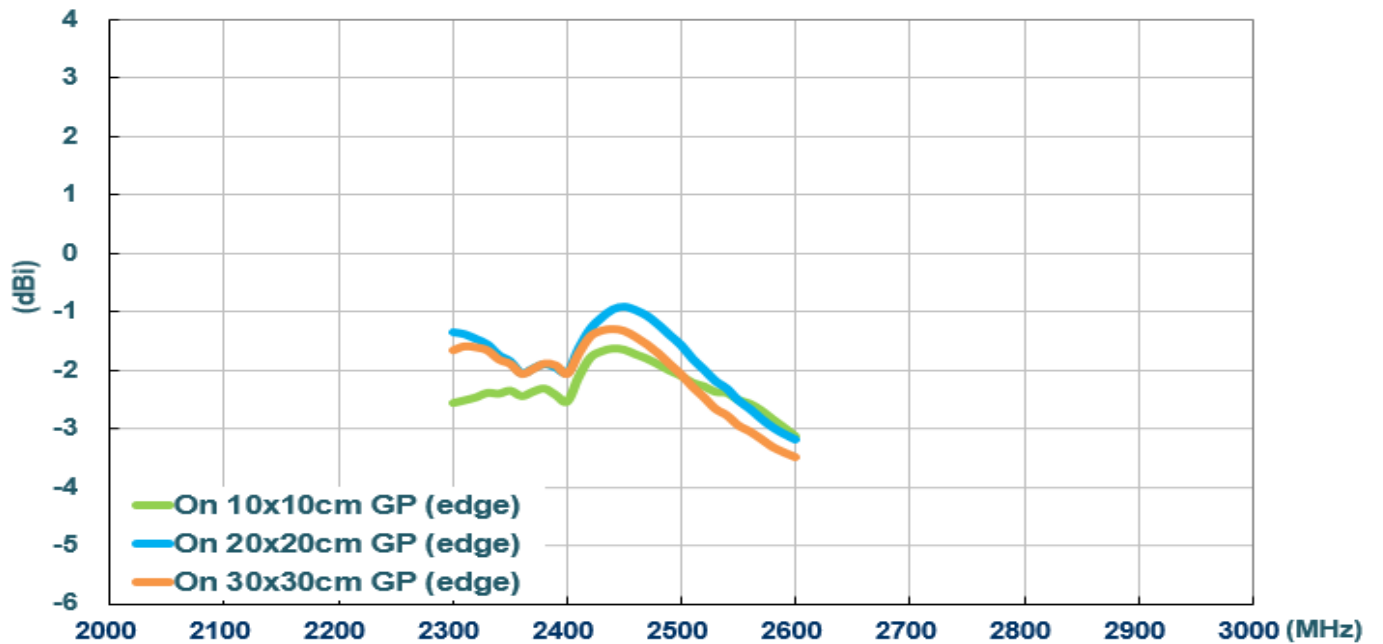

Figure 13. Average gain of WCM.01 antenna with different ground plane size

4. Antenna Radiation Patterns

The antenna radiation patterns were measured in a CTIA certified ETS Anechoic Chamber. The measurement setup is shown below.



In Free Space

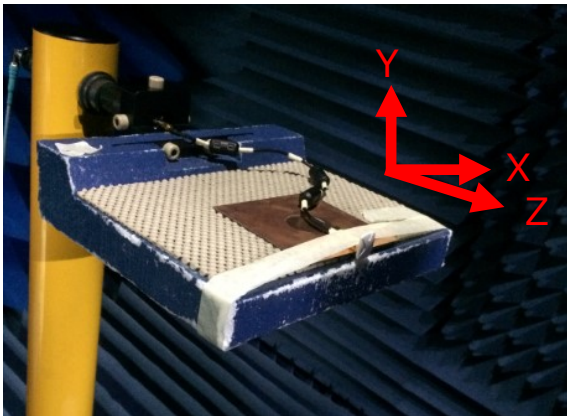

On 10*10cm ground plane (Center Edge)

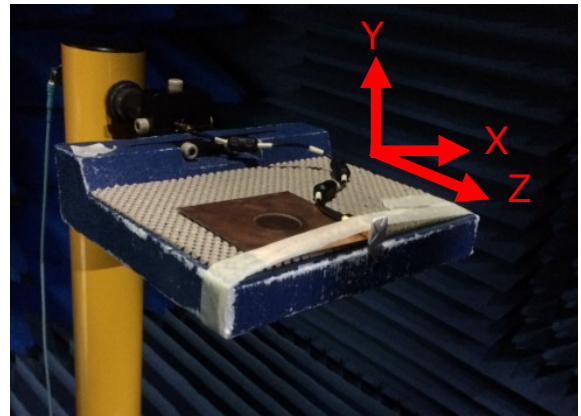

On 10*10cm ground plane (Off Center Edge)

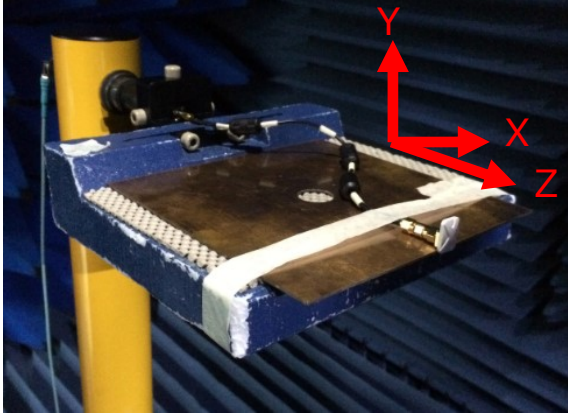

On 20*20cm ground plane (Center Edge)



On 20*20cm ground plane (Off Center Edge)

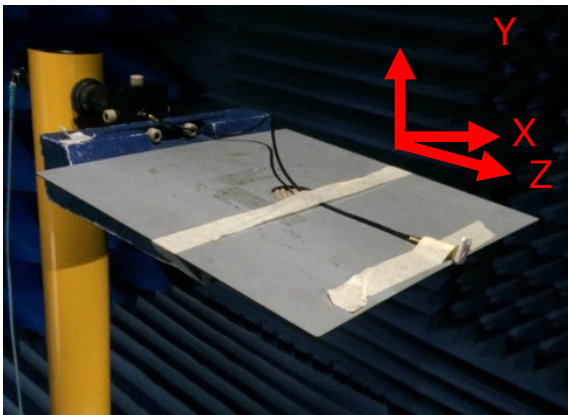

On 30*30cm ground plane (Center Edge)

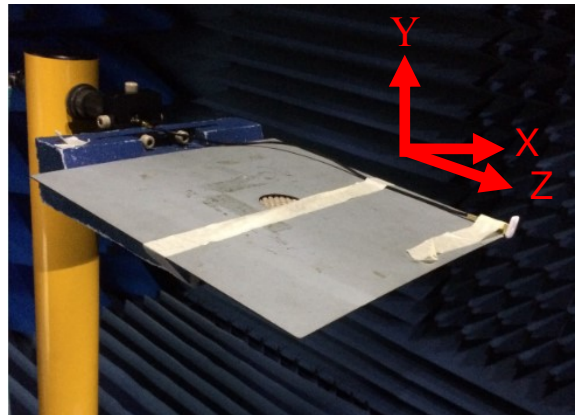

On 30*30cm ground plane (Off Center Edge)

Figure.14. Testing Setup in ETS Anechoic Chamber

4.1 2D Radiation Pattern (In free space)

XY Plane

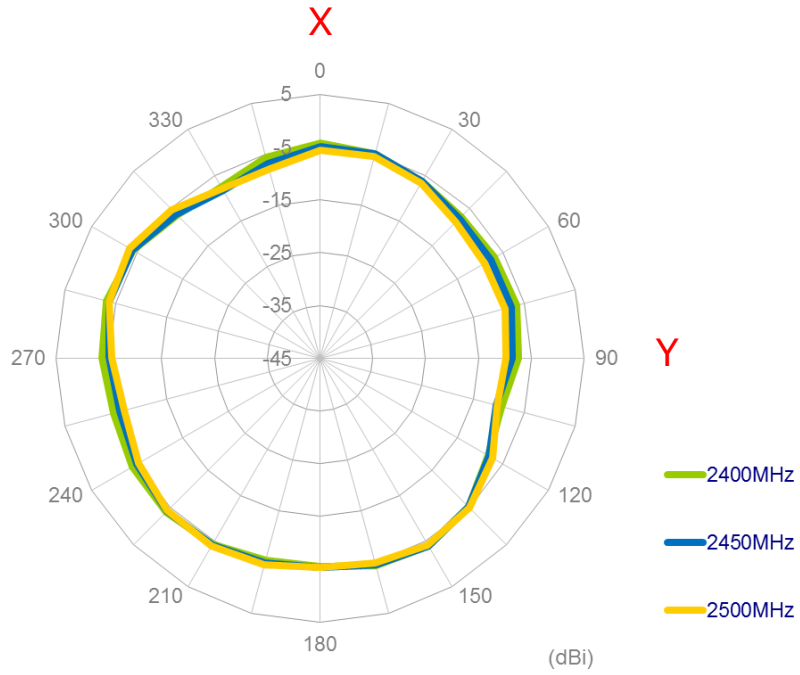

XZ Plane

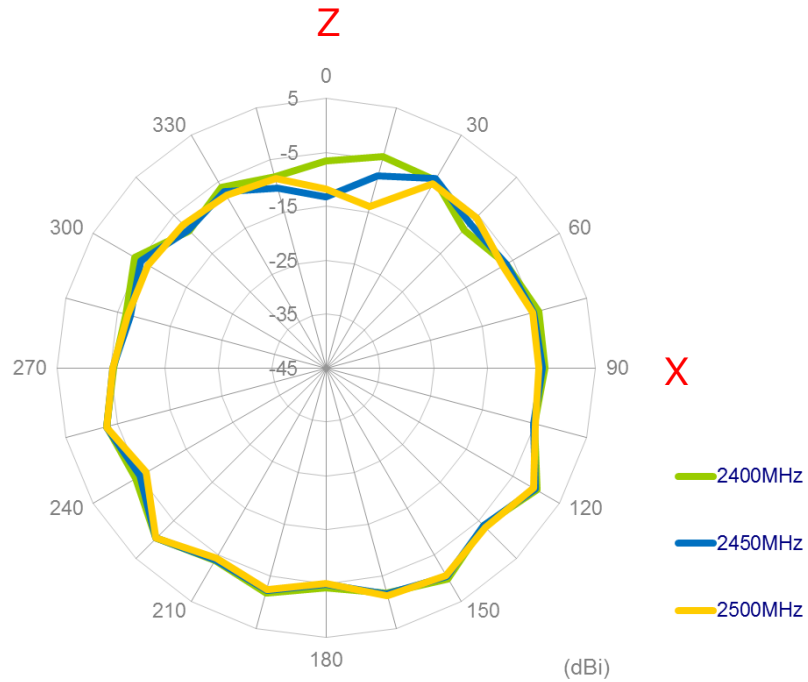

YZ Plane

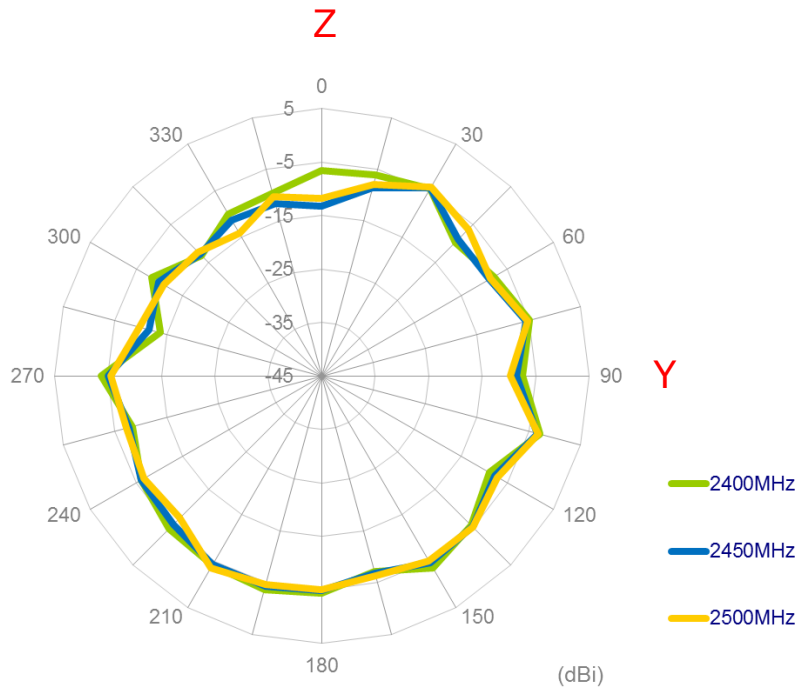

4.2 3D Radiation Pattern (In free space)

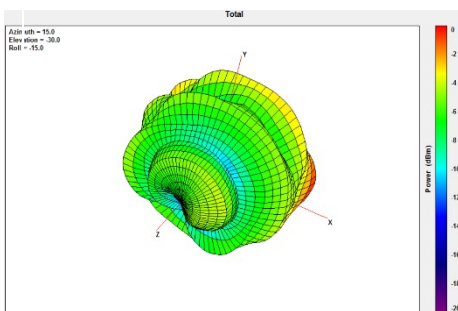

2400MHz

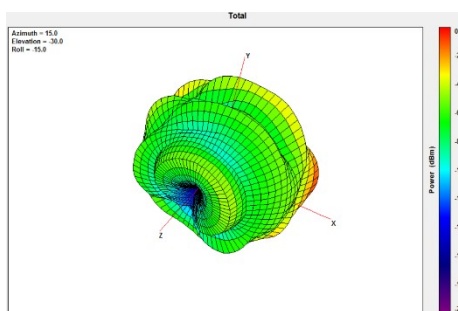

2450MHz

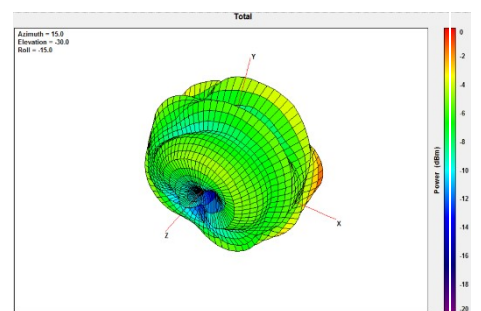

2500MHz

4.3 2D Radiation Pattern (On 10*10cm ground plane center edge)

XY Plane

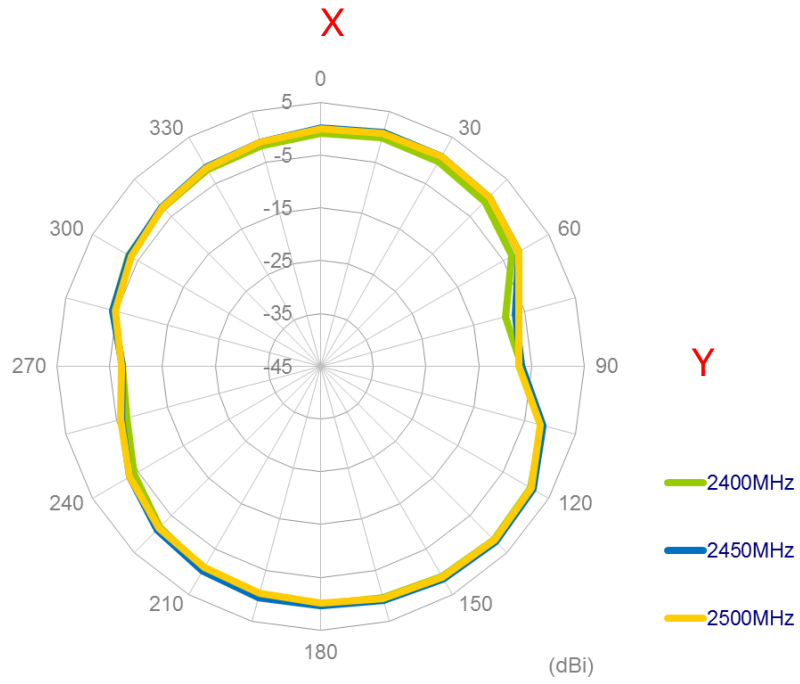

XZ Plane

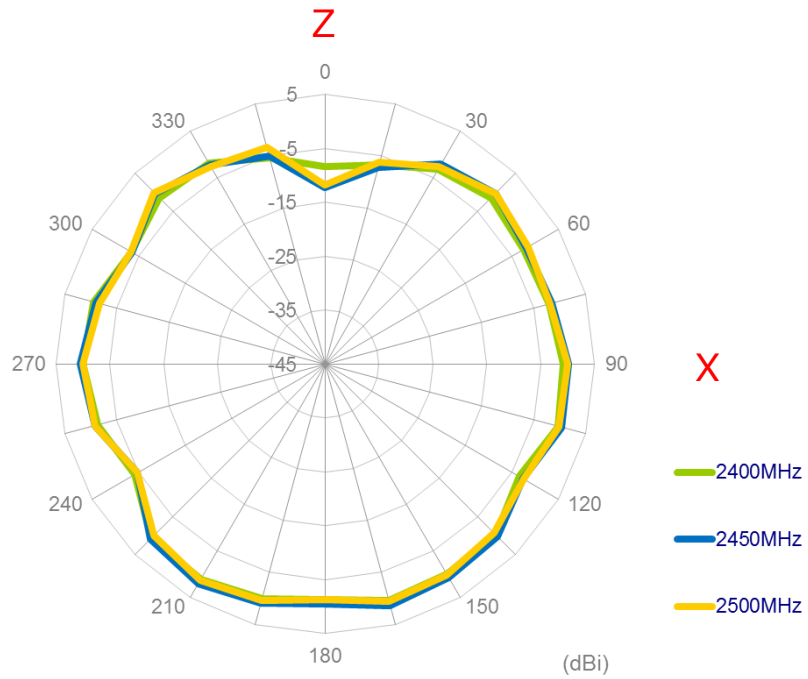

YZ Plane

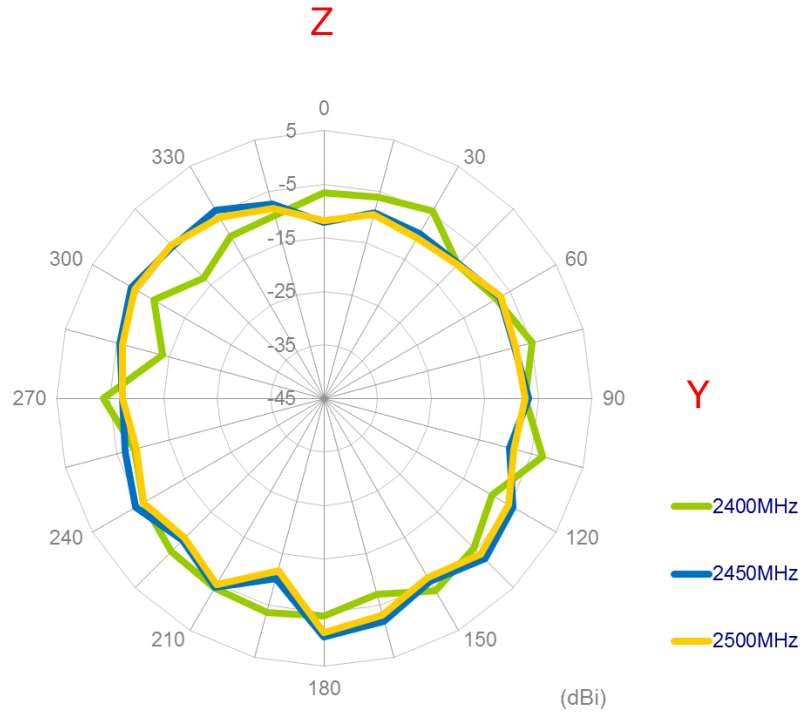

4.4 3D Radiation Pattern (On 10*10cm ground plane center edge)

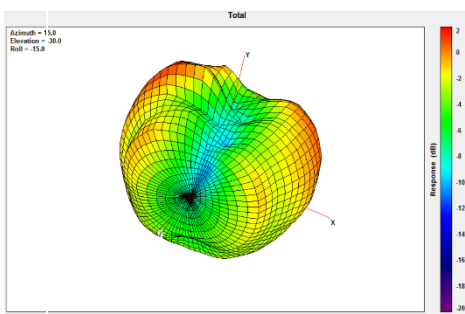

2400MHz

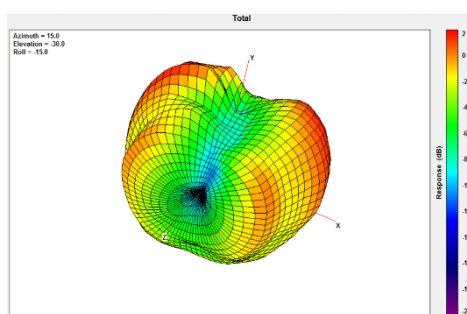

2450MHz

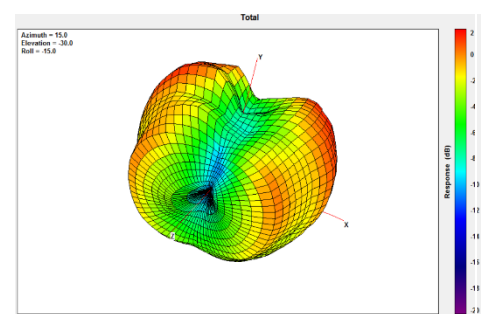

2500MHz

4.5 2D Radiation Pattern (On 10*10cm ground plane off center edge)

XY Plane

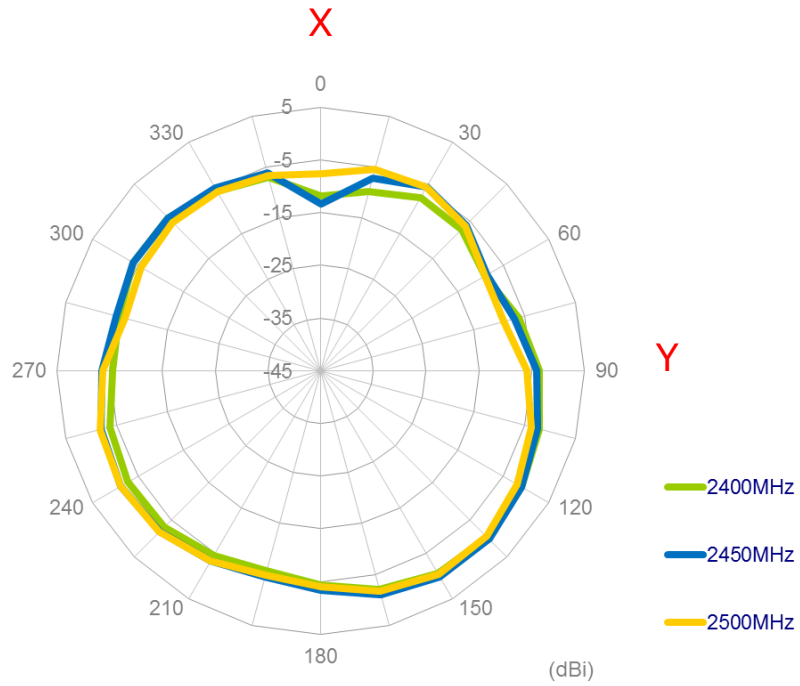

XZ Plane

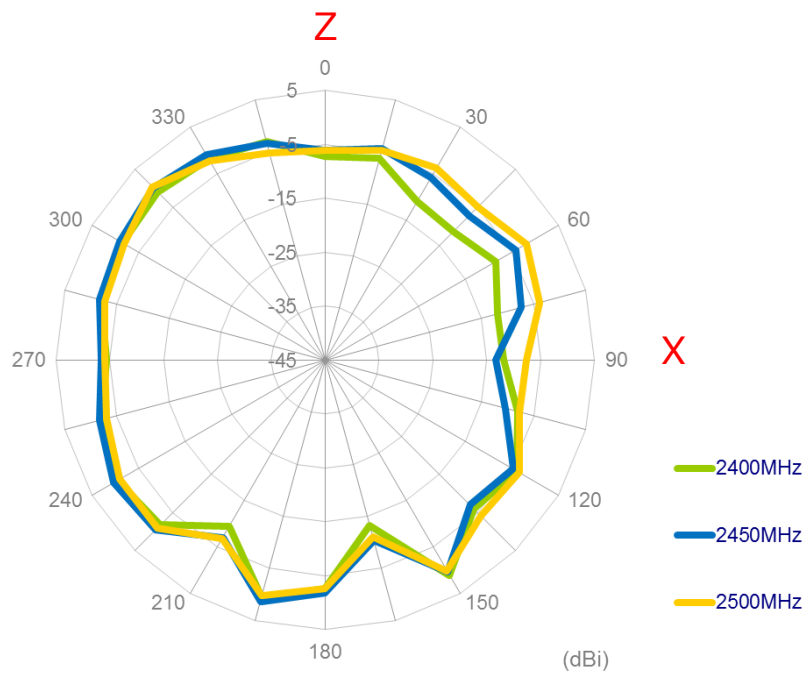

YZ Plane

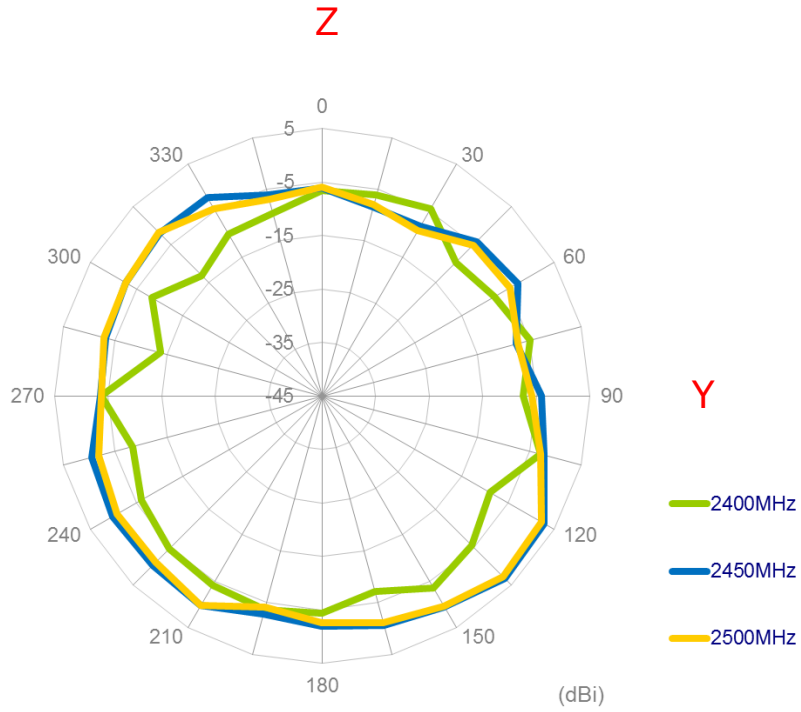

4.6 3D Radiation Pattern (On 10*10cm ground plane off center edge)

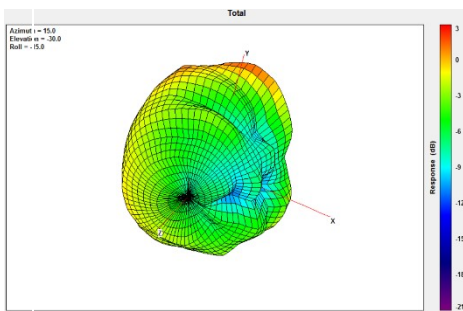

2400MHz

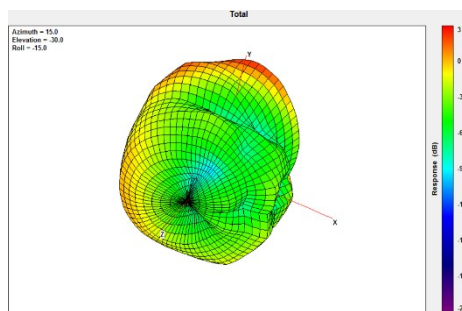

2450MHz

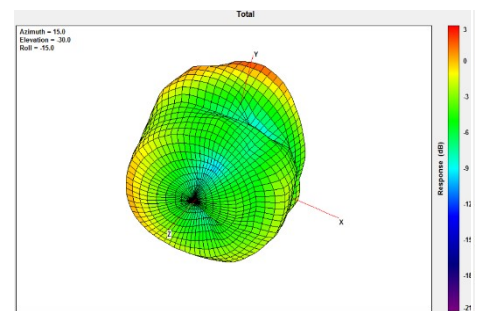

2500MHz

4.7 2D Radiation Pattern (On the 20*20cm ground plane center edge)

XY Plane

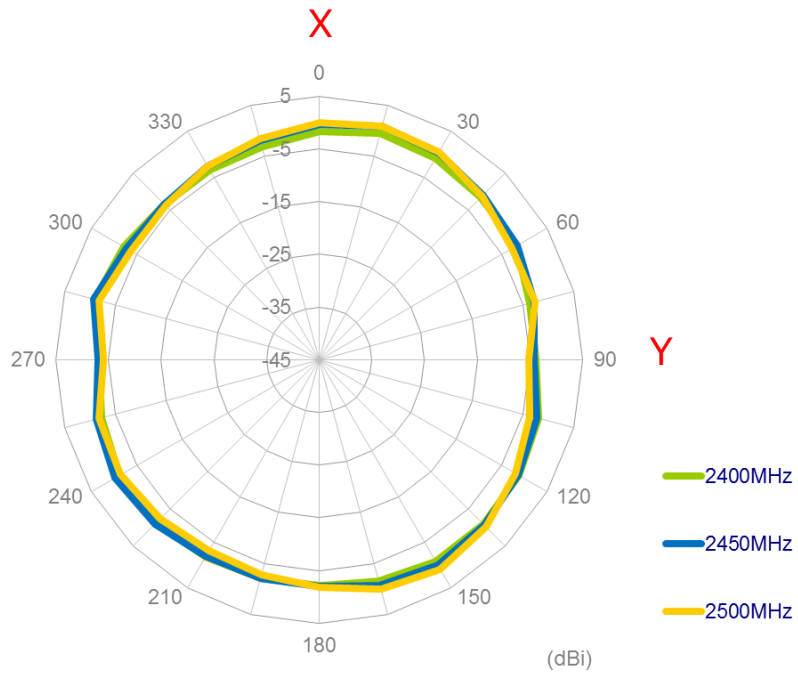

XZ Plane

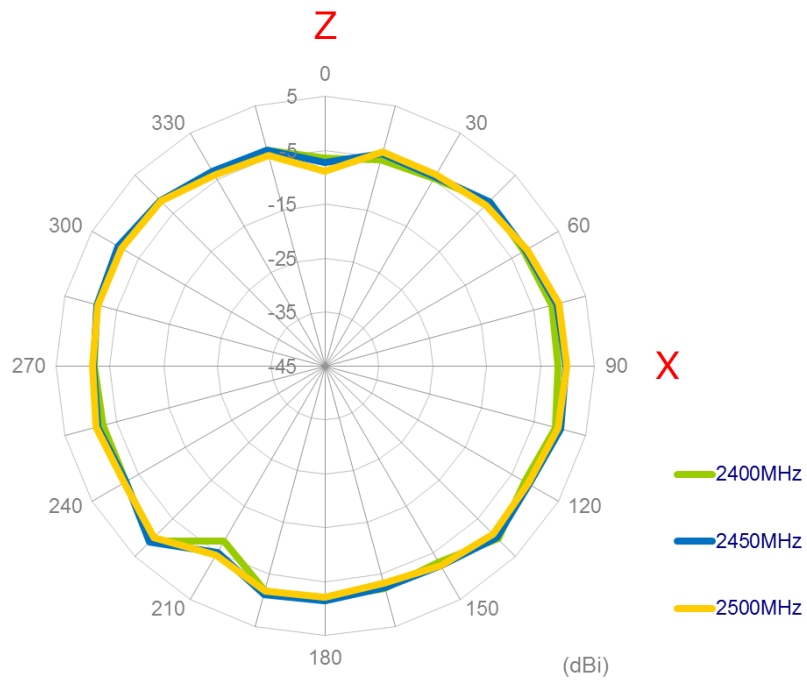

YZ Plane

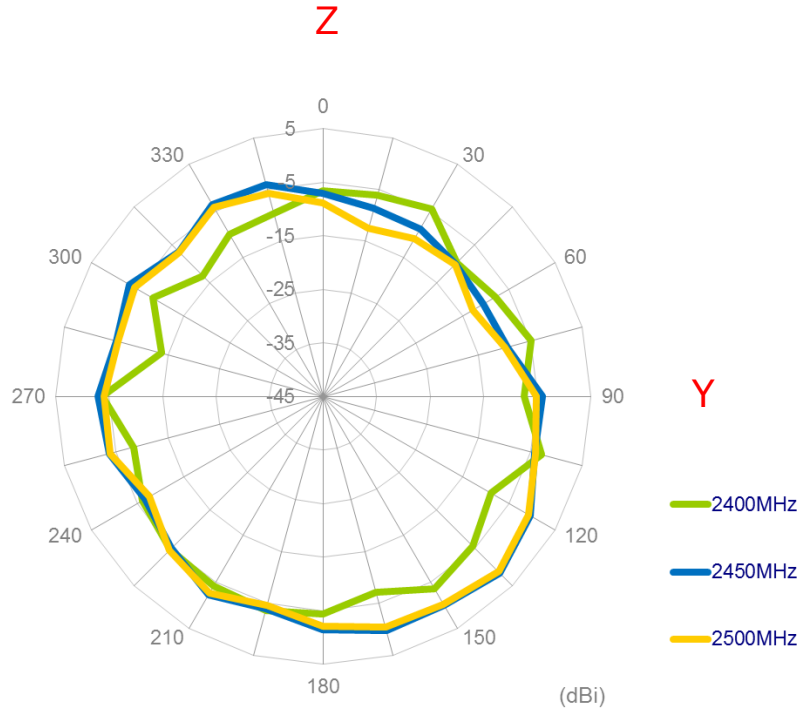

4.8 3D Radiation Pattern (On 20*20cm ground plane center edge)

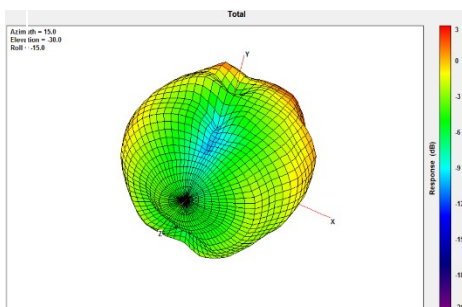

2400MHz

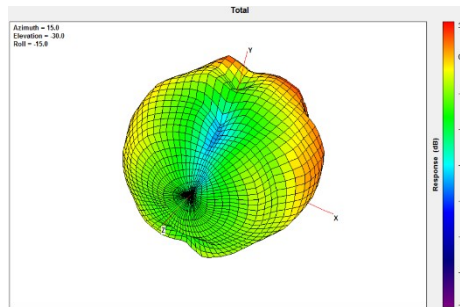

2450MHz

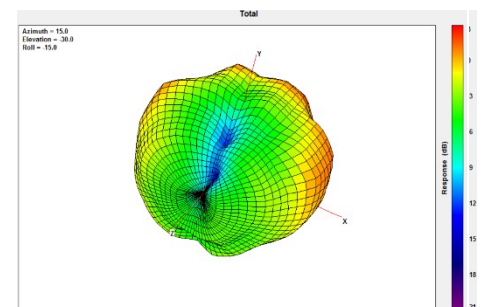

2500MHz

4.9 2D Radiation Pattern (On 20*20cm ground plane off center edge)

XY Plane

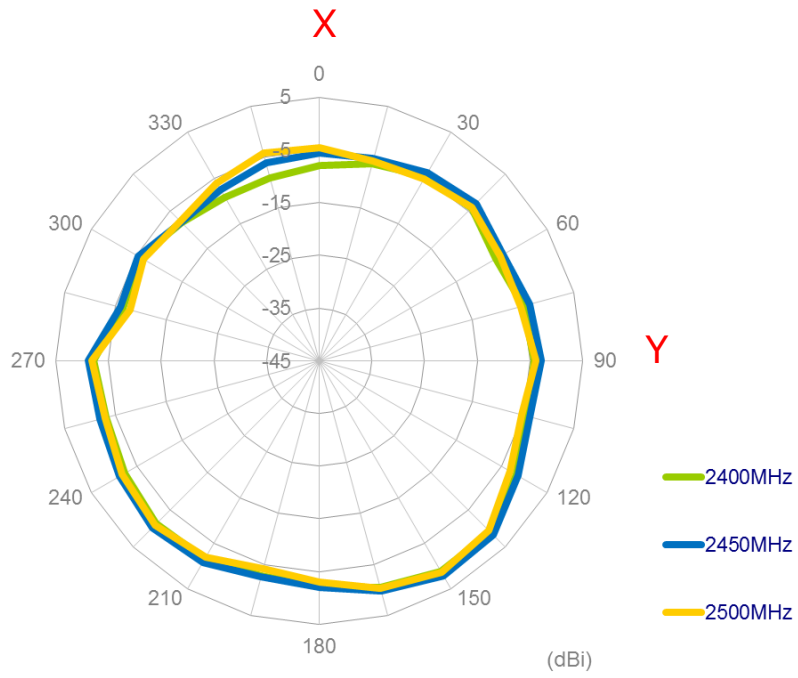

XZ Plane

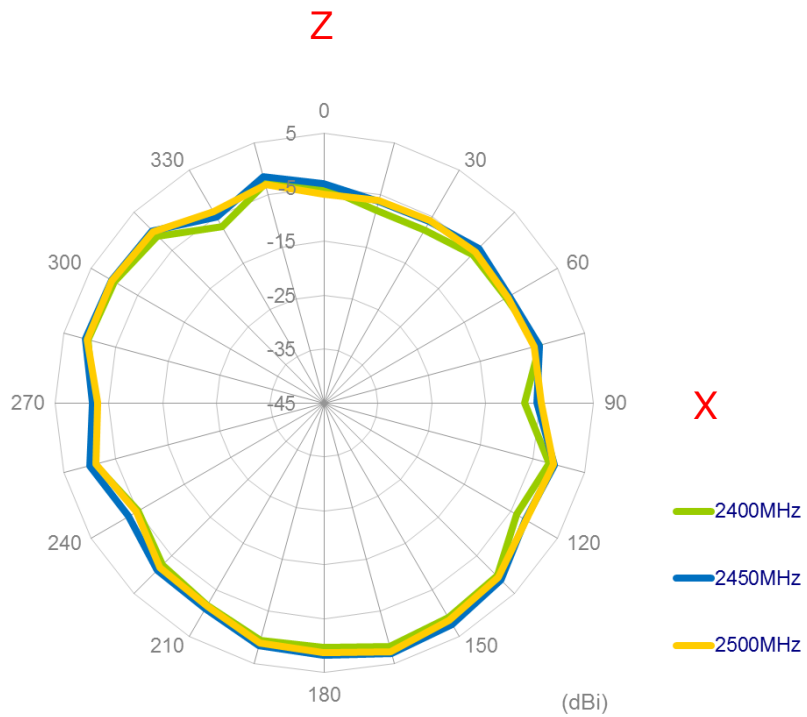

YZ Plane

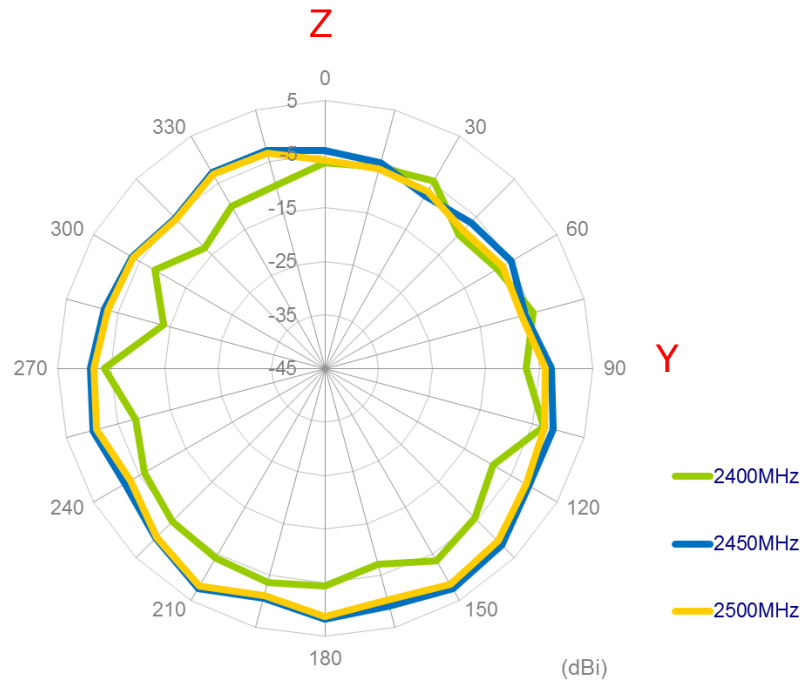

4.10 3D Radiation Pattern (On 20*20cm ground plane off center edge)

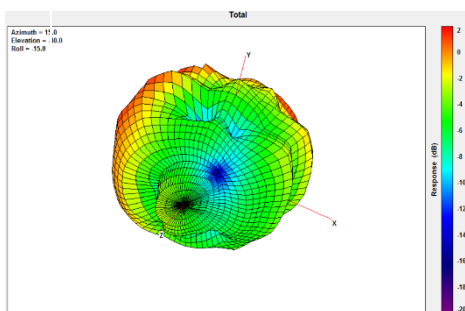

2400MHz

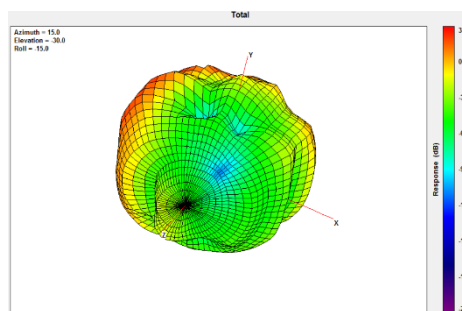

2450MHz

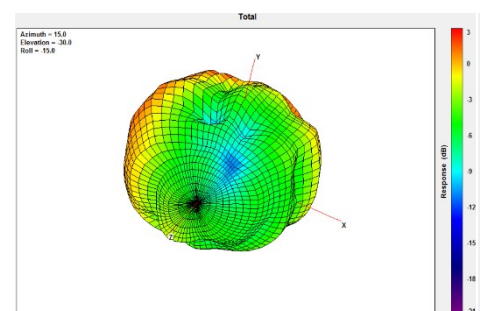

2500MHz

4.11 2D Radiation Pattern (On 30*30cm ground plane off center edge)

XY Plane

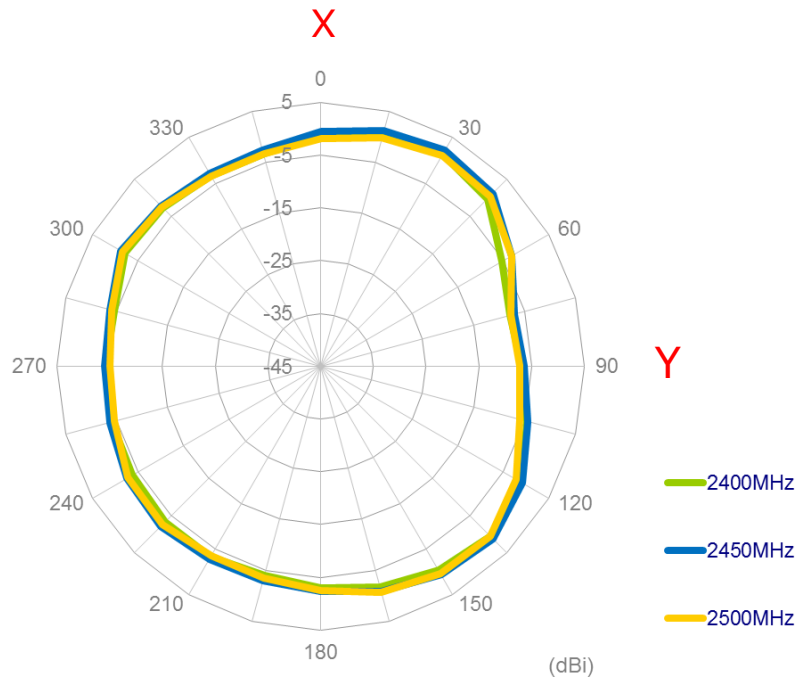

XZ Plane

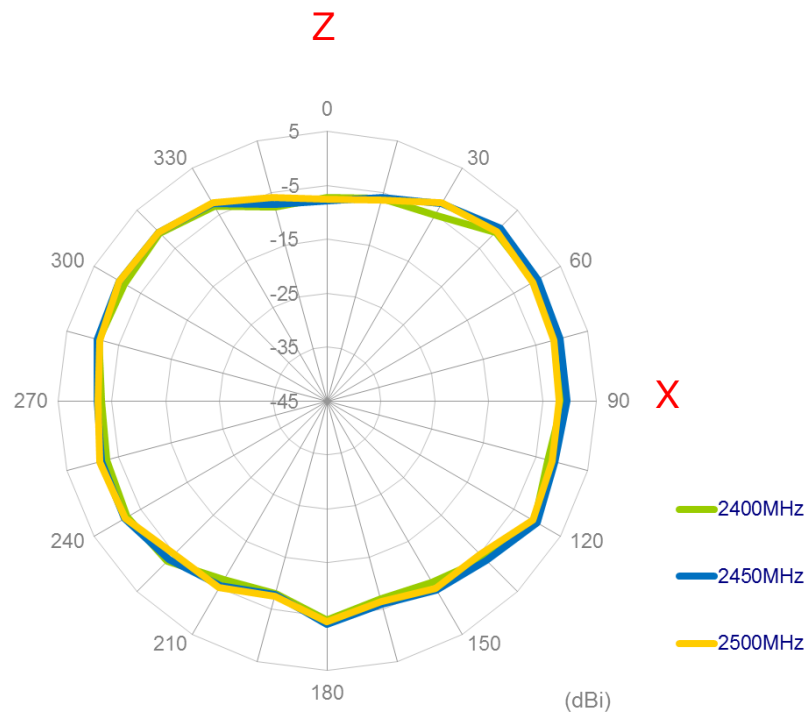

YZ Plane

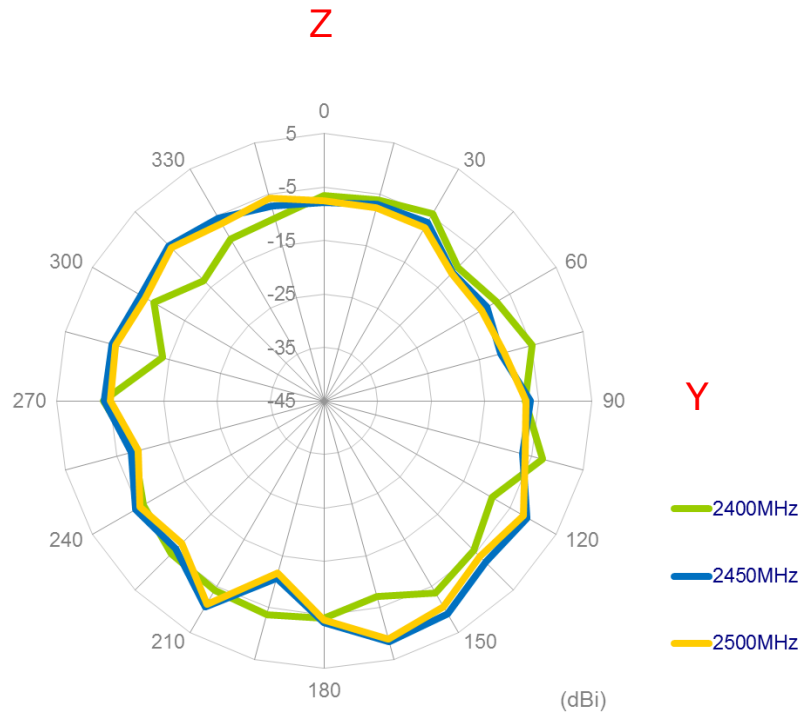

4.12 3D Radiation Pattern (On 30*30cm ground plane center edge)

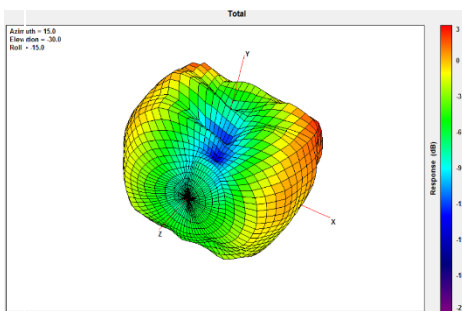

2400MHz

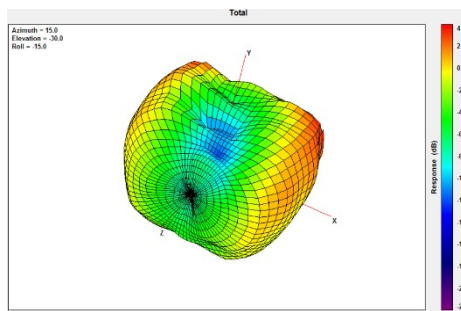

2450MHz

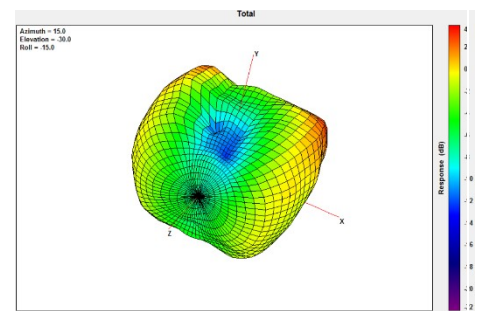

2500MHz

4.13 2D Radiation Pattern (On 30*30cm ground plane off center edge)

XY Plane

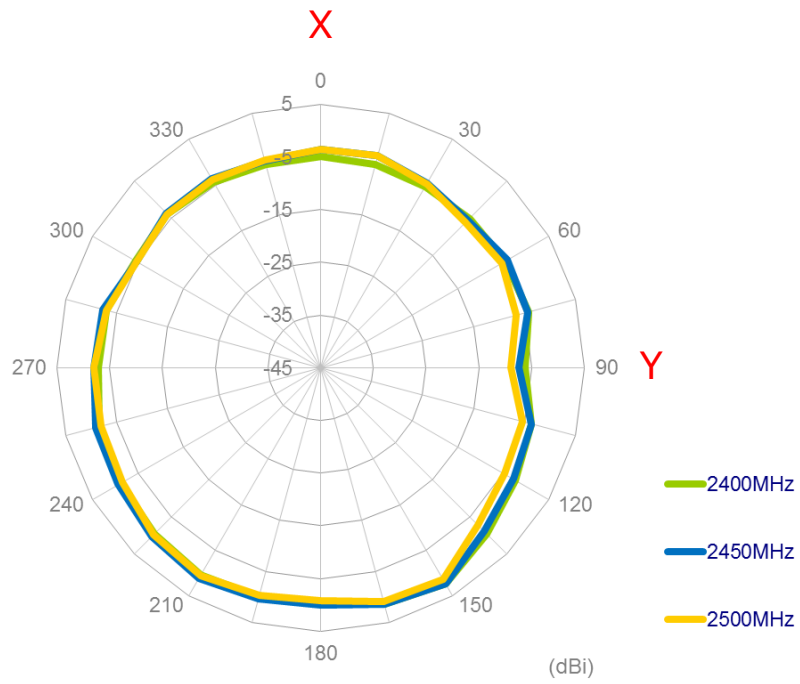

XZ Plane

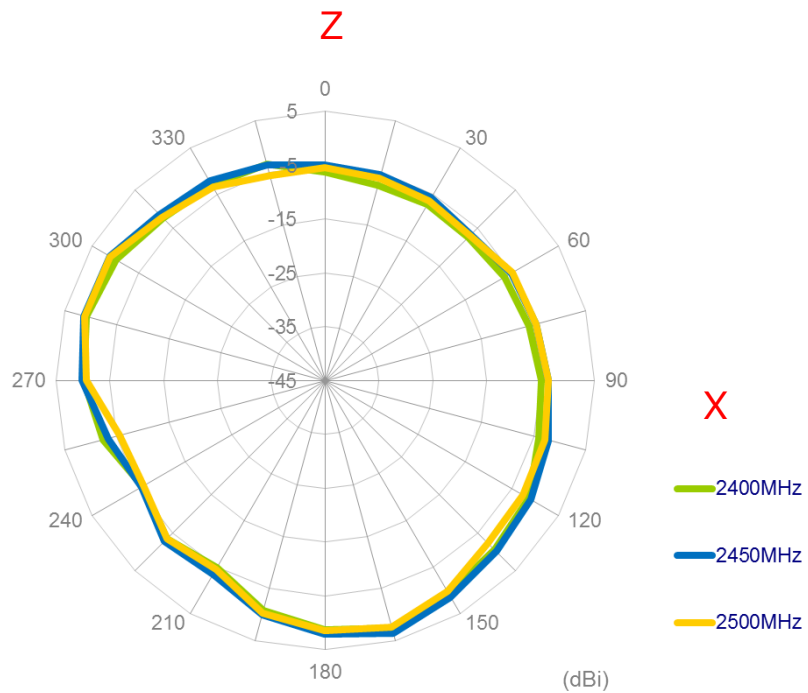

YZ Plane

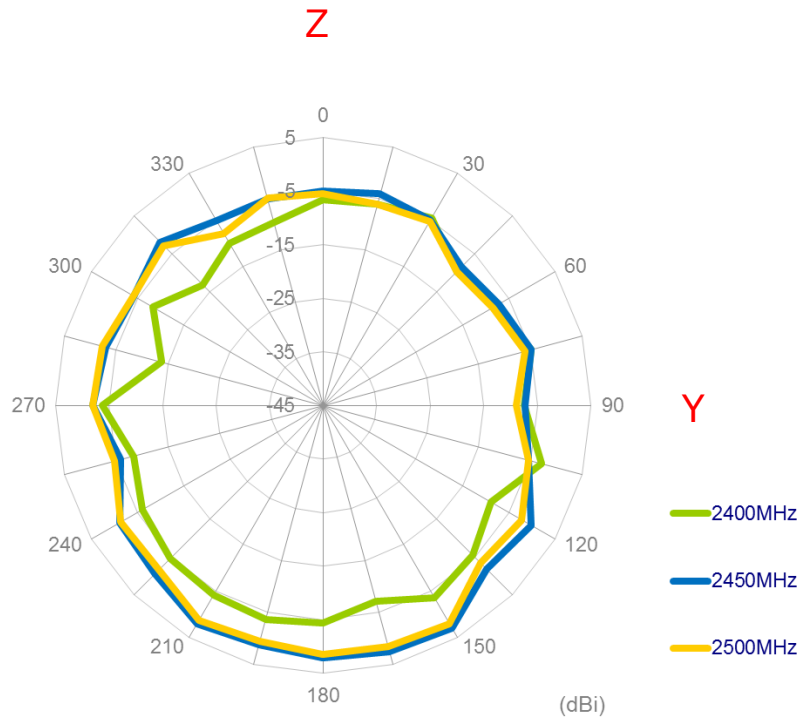

4.14 3D Radiation Pattern (On 30*30cm ground plane off center edge)

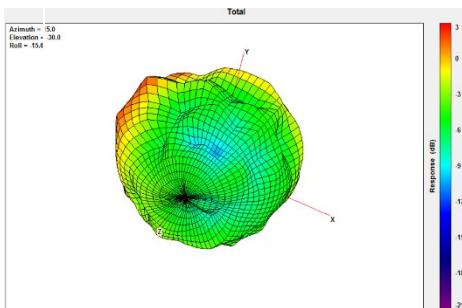

2400MHz

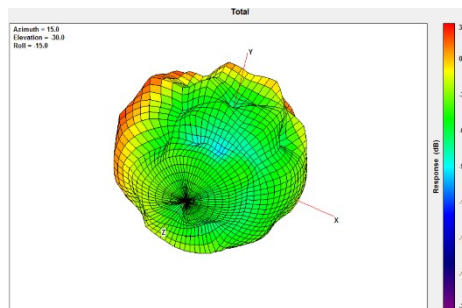

2450MHz

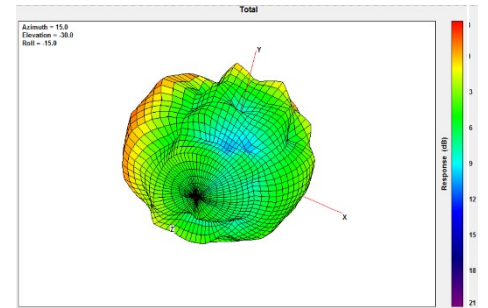

2500MHz

5. DRAWING (Unit: mm)



3D View

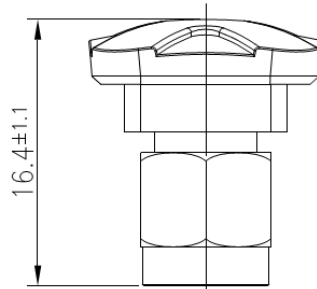

Top View

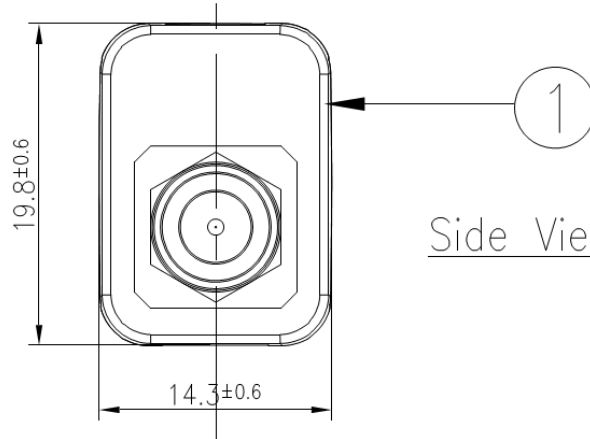

Side View

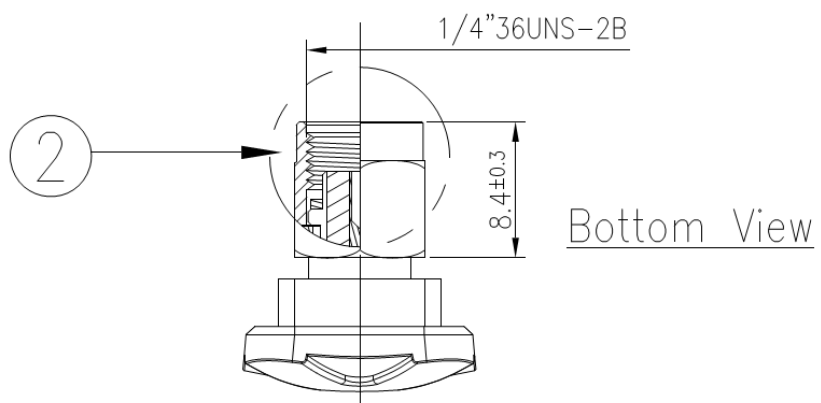

Bottom View

	Name	Material	Finish	QTY
1	External housing	ABS	White	1
2	RP-SMA(M)	Brass	Au Plated	1

6. Packaging

1 pcs WCM.01.0151W per PE Bag
 PE Bag Dimensions - 80*40mm
 Weight - .007g

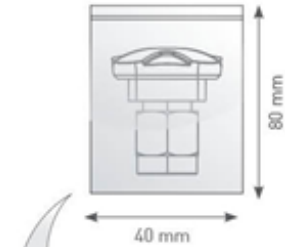

100 PE Bags per Large PE Bag
 100 pcs WCM.01.0151W per Large PE Bag
 Large Polybag Dimensions - 240*170mm
 Weight - 0.7kg

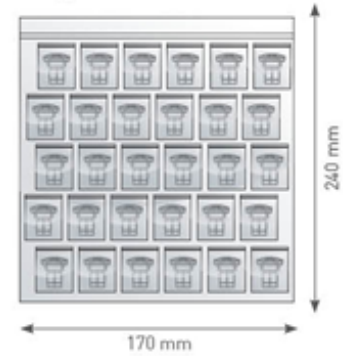

15 Large PE bags per carton
 1500 pcs WCM.01.0151W per carton
 Carton Dimensions - 360*310*160mm
 Weight - 11kg

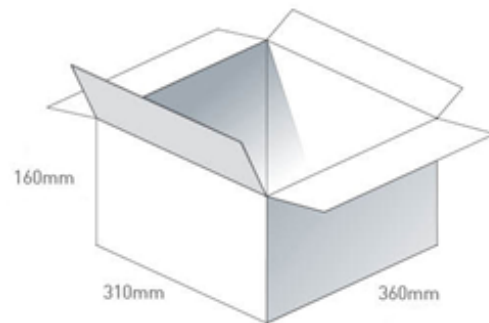

Pallet Dimensions 1080mm*930m*1430mm
 72 Cartons per Pallet
 12 Cartons per layer
 6 Layers

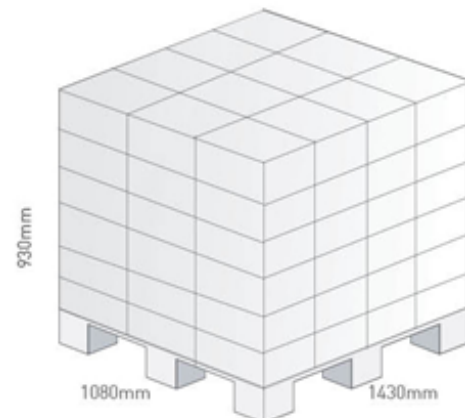



Taoglas makes no warranties based on the accuracy or completeness of the contents of this document and reserves the right to make changes to specifications and product descriptions at any time. Taoglas reserves all rights to this document and the information contained herein.

Reproduction, use or disclosure to third parties without express permission is strictly prohibited.

Copyright © Taoglas