

OBSOLETE PRODUCT

Contact Factory for Replacement Model

DESCRIPTION

The Datal Datamite DM-2000 is the first LED 3 1/2 digit panel meter to sell for below \$100.00 in single quantities. This has been made possible by the wide acceptance of Datal Systems line of Datamite Digital Panel Meters which have a proven record of performance and reliability.

The DM-2000 combines the ease and accuracy of digital readout with high input impedance and noise rejection to provide an inexpensive digital panel meter (digital voltmeter) that will enhance the operation, performance and appearance of any instrumentation system.

The DM-2000 is ideal for new equipment design or may be utilized in updating existing instruments or systems that require a stable, accurate digital readout for voltage. Simple to install, the DM-2000 is supplied complete and ready to operate, requiring only a connection of an input signal and power cable. Applications include measuring or any parameter for which a suitable output voltage is available. These include absorption, acceleration, current, displacement, distortion, emission, flow, frequency, Ph, pressure, strain, torque, and many others.

The DM-2000 provides a differential input with a 100 MegOhms input impedance and a common mode rejection of 70 db at 60 Hz. The input range is ±1.999 volts or ±199.9 millivolts. The display is 3 1/2 digits including automatic polarity and overflow indication. In addition the output is presented to the I/O connector as BCD/TTL information.

High quality computer grade components, superior workmanship and wide-safety-margin designs combine to make Datamite DM-2000 a must in your present equipment or future generation designs.

WORLD'S FIRST LED 3 1/2 DIGIT DPM FOR UNDER \$100 IN SINGLE QUANTITY

FEATURES

- ±199.9mV or ±1.999V Full Scale Inputs
- True Floating Bipolar Differential Input
- Automatic Polarity and Overflow Display
- Up to 200 Readings per Second
- Operates From Single +5VDC Supply
- Solid State Led Display
- Adjustable Zero Control Compensating For External Offset Voltages

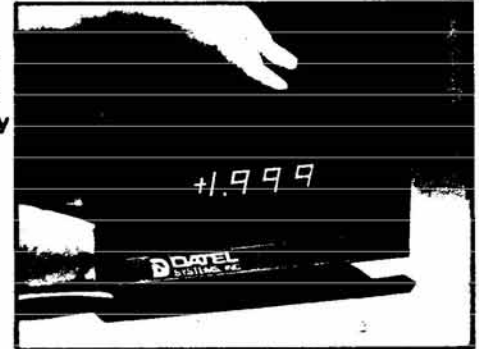

MOUNTING DETAILS

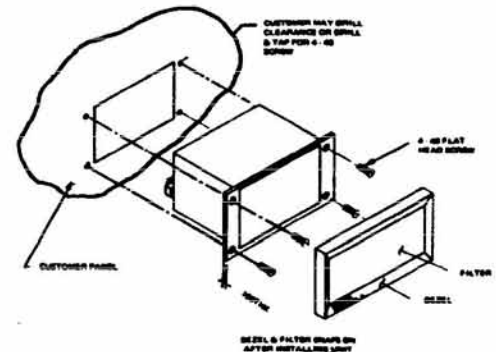
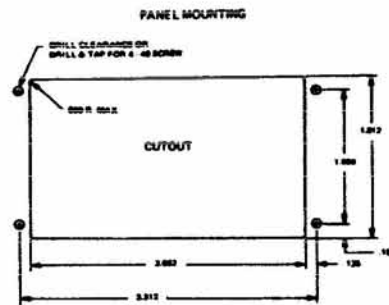

Calibration Procedure (Using Trimpots Shown At Right)

The following adjustment procedure is recommended after allowing for a five minute warm-up.

Balance Control

- 1) Short the analog input terminals to analog common. (See I/O chart for proper pin connection.)
- 2) Rotate the balance control until the display is flickering between (+) zero and (-) zero.

Zero Control

- 1) Connect a precision voltage reference source to the analog input terminals.
- 2) Adjust the voltage output from the reference source to .3LSD (30µV Model A, 300µV Model B). Rotate the zero control until the LSD (Least significant digit) flickers between zero and one.

Full Scale Control

- 1) Adjust the output from the reference source to 1.990 volts. Rotate the full scale control of the panel meter until the meter displays 1.990 volts.

MECHANICAL DIMENSIONS (INCHES)

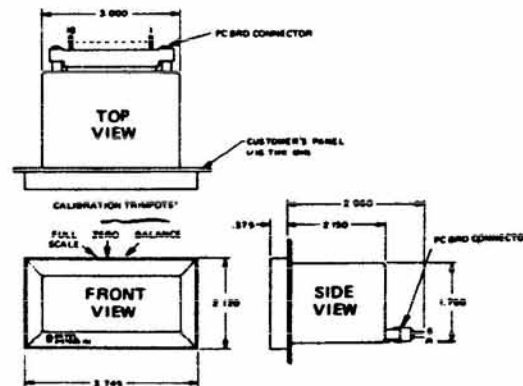

INPUT/OUTPUT CONNECTIONS

	PC BRD CONNECTOR BOTTOM TOP		
	A	B	
ANALOG INPUT (LSD)	1	1	ANALOG INPUT (MSD)
SHIELD GROUND	2	2	SHIELD GROUND
NOT USED	3	3	NOT USED
NOT USED	4	4	LOGIC GROUND
DECIMAL POINT 100	5	5	BIT 1 OUT
DECIMAL POINT 10	6	6	BIT 2 OUT
DECIMAL POINT 1	7	7	BIT 4 OUT
S.O.C. (STATUS)	8	8	BIT 8 OUT
OVERLOAD SCALE OUT	9	9	BIT 10 OUT
INT. START GATE	10	10	BIT 20 OUT
INT. START ADJ.	11	11	BIT 40 OUT
INT. START OUT	12	12	BIT 80 OUT
START INPUT	13	13	BIT 100 OUT
LAMP TEST	14	14	BIT 200 OUT
MODE OUT	15	15	BIT 400 OUT
SIGN OUT	16	16	BIT 800 OUT
NOT USED	17	17	NOT USED
POWER INPUT (+5VDC RETURN)	18	18	POWER INPUT, +5VDC

SPECIFICATIONS Typical @ 25°C, 5 minutes warm up, +5VDC ±.25V unless noted

PARAMETER	MODEL DM-2000	PARAMETER	MODEL DM-2000
Input		Polarity	Input signal polarity indicated with a HIGH-positive, LOW-negative. Loading: 2TTL loads (1)
Input Voltage Range	±199.9mV DM-2000A ±1.999V DM-2000B	Overflow (OF) >±2V(A)>±2V(B) (Connection A9)	HIGH-input signal within range. LOW-input signal outside range. Loading: 2TTL loads (1)
Input Impedance	>100 MEGOHMS	End of Conversion (EOC) (Connection A8)	HIGH – During the reset and conversion period. LOW – Conversion complete. Loading: 2TTL loads (1)
Input Bias Current	20 nA	Input/Output Control	
Input Configuration	Differential	External Start Conversion Command (Connection A13)	Positive pulse 100 nsec min. Transition from "LOW" to "HIGH" resets output register and blanks readout. The conversion process is initiated upon return from "HIGH" to "LOW". Loading: 1TTL load. (1)
Input Polarity	Bipolar – Automatic	Internal Start Gate (Connection A10)	Controls internal start clock "HIGH" – Run loading: 1TTL load (1) "LOW" – Stop
Common Mode Rejection	70dB @ 60Hz	Internal Start Adjust (Connection A11)	Controls Rate of Internal Start Clock – see Applications Section.
Common Mode Voltage	±2V max. to digital output common	Internal Start Out (Connection A12)	Positive Pulse Output of Internal Start Clock – see Applications Section.
Performance		Lamp Test Input (Connection A14)	Grounding this input displays + 1888 for testing all display segments. Loading: Sink 35mA
Accuracy @ 25°C	±0.05% of Reading ±1 Count	Decimal Point Inputs (DP1, DP10, DP100)	Grounding inputs illuminates corresponding decimal points on the display. Loading: Sink 15mA
Resolution	100µVolts (DM-2000-A), 1mVolt (DM-2000-B)	Physical (2)	
Temperature Coefficient	50ppm/°C	Case Size	3"W x 1.75"H x 2.25"D
Conversion Speed	0 to 200 Conversions/Second. See Diagrams below	Case Material	Black LEXAN
Input Settling Time	50 µsec for a F.S. Change	Weight	6 oz. Approx.
Operating Temperature Range	0°C to +60°C	Mounting	Through a 1.75" x 3.00" Cut-Out and Secured with Four 4-40 Tapped Holes
Storage Temperature Range	-20°C to +85°C		
Warm Up Time	5 Minutes to Specified Accuracy		
Adjustments	Zero, Balance, Full Scale Located Behind Snap On Front Bezel		
Input Power	5VDC ±0.25VDC @ 750mA		
Display Output			
Display Type	Solid State LED for Data Digits, 100% Overrange, Overflow, Decimal point and Polarity – Character Height .27 in.		
Overflow	Indicated by the Letters "OF"		
Decimal Points	Selectable at rear Connector		
Data Outputs (1)			
BCD Outputs	12 Parallel Lines, BCD (8-4-2-1) Positive Logic Loading: 2TTL loads (1)		
Overrange (Connection A15)	>1000 counts indicated with a HIGH. Loading: 2TTL loads (1)		

Notes:
 (1) Low: V out ("0") = ≤+0.8V. HIGH: V out ("1") = ≥+2.4V.
 (2) Module is fully repairable and features snap-together PC Boards.

APPLICATIONS

SINGLE ENDED INPUT

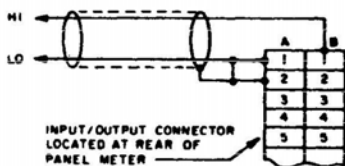

FOR SINGLE ENDED INPUT, CONNECT "LO" AND "SHIELD" TOGETHER AT THE CONNECTOR (A1 TO A2)

DIFFERENTIAL INPUT

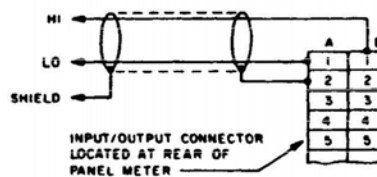

FOR DIFFERENTIAL INPUT THE COMMON MODE VOLTAGE BETWEEN "LO" AND "SHIELD" MUST NOT EXCEED THE MAXIMUM SPECIFIED COMMON MODE VOLTAGE

USING THE METER WITH THE INTERNAL "START" CLOCK

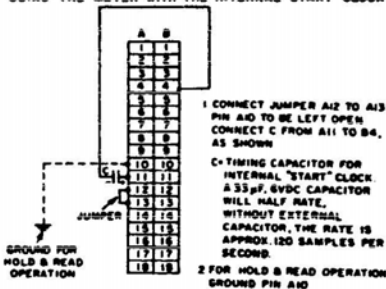

USING THE METER WITH AN EXTERNAL "START"

