

RFLA9003

Dual Low Noise Amplifier Module
1710MHz to 2180MHz

RFMD's RFLA9003 is a dual Low Noise Amplifier module with external connections to both LNAs. These LNAs feature a shut-down mode to turn off the LNA and provide up to 15dBm drive level without gain expansion and self-biasing in shutdown mode. Noise figure of 1.2dB and input P1dB of -3.5dBm make this component ideal for receiver input lineups. The RFLA9003 is packaged in a small 4.0mm x 4.0mm leadless laminate MCM. This module is internally matched to 50Ω on all RF ports making it easy to use with no external matching components required.



Package: MCM, 24-pin,
4.0mm x 4.0mm

Features

- Frequency Range 1710MHz to 2180MHz
- Internally Matched to 50Ω on all RF Ports
- Shutdown Mode with +40dB Isolation
- Gain = >15dB per LNA
- Noise Figure of 1.2dB Typical
- Single +4.0V Supply
- Small 24-Pin, 4.0mm x 4.0mm, Multi-Chip Module (MCM)

Applications

- Cellular Repeaters
- General Purpose LNA

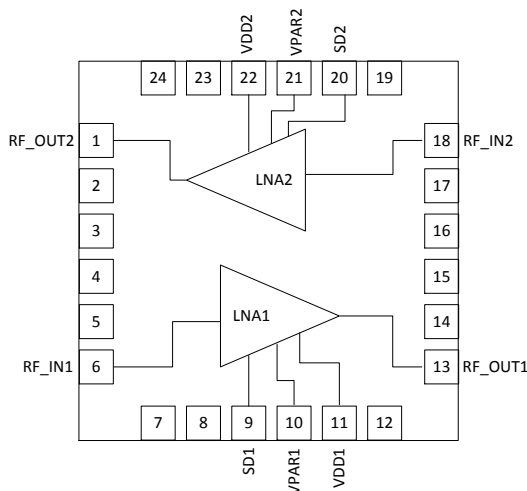

Functional Block Diagram

Ordering Information

RFLA9003SQ	Sample bag with 25 pieces
RFLA9003SR	7" Reel with 100 pieces
RFLA9003TR13	13" Reel with 2500 pieces
RFLA9003PCK-410	1710MHz to 2180MHz PCBA with 5-piece sample bag

Absolute Maximum Ratings

Parameter	Rating	Unit
Supply Voltage	+5.5	V _{DC}
Control Voltage	+5.5	V _{DC}
DC Supply Current	130	mA
Power Dissipation	770	mW
Max RF Input Power	15	dBm
Operating Temperature (T _{CASE})	-40 to +85	°C
Storage Temperature Range	-40 to +150	°C
Junction Temperature (T _J)	150	°C
ESD Rating - Human Body Model (HBM)	1000 (Class 1C)	V
Moisture Sensitivity Level	MSL3	



Caution! ESD sensitive device.



RFMD Green: RoHS status based on EU Directive 2011/65/EU (at time of this document revision), halogen free per IEC 61249-2-21, < 1000ppm each of antimony trioxide in polymeric materials and red phosphorus as a flame retardant, and <2% antimony in solder.

Exceeding any one or a combination of the Absolute Maximum Rating conditions may cause permanent damage to the device. Extended application of Absolute Maximum Rating conditions to the device may reduce device reliability. Specified typical performance or functional operation of the device under Absolute Maximum Rating conditions is not implied.

Nominal Operating Parameters

Parameter	Specification			Unit	Condition
	Min	Typ	Max		
Individual LNA Performance					Temp = 25°C, V _{CC} = 4V, Standard Application Circuit
Frequency Range	1710		2180	MHz	
Gain (On Mode)	15	18	21	dB	SD = 0V
Noise Figure		1.2	1.6	dB	
Input P1dB	-6.5	-3.5		dBm	
Input IP3	6.6	9		dBm	
Gain (Off Mode)		-39		dB	SD = 4V
Gain Delta	>40			dB	Gain LNA (on mode) – Gain LNA (off mode), 1950MHz
Input Return Loss		9.7		dB	
Output Return Loss		12.5		dB	
Isolation (LNA1 OUT to LNA2 IN)	35	47.5		dB	
Gain Compression Slope	-1.1	-1	-0.1	dB	Gain compresses monotonically with increased input power once saturated
Overall Power Supply					Temp = 25°C, V _{CC} = 4V, Standard Application Circuit
Supply Voltage	3.5	4	5	V	
SD Voltage	0		VCC	V	
Logic High	1.7		VCC	V	
Logic Low	0		0.6	V	
Thermal Resistance		118		°C/W	85°C at 4.5V at 35mA
Current	14	29	36	mA	On Mode, SD = 0V
	0.5	3.5	6	mA	Off Mode, SD = 4V

Typical Performance: T=25°C, VDD = 4V unless otherwise noted

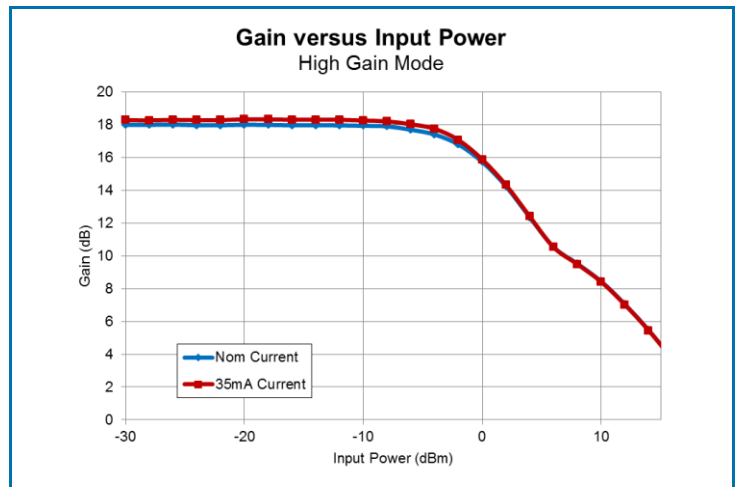
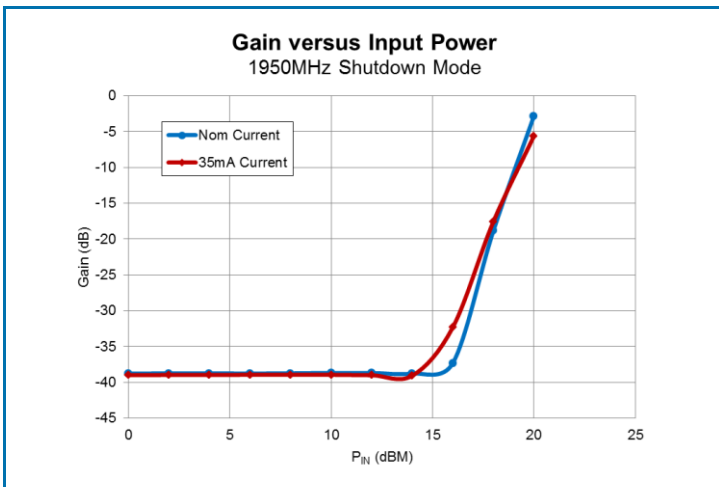
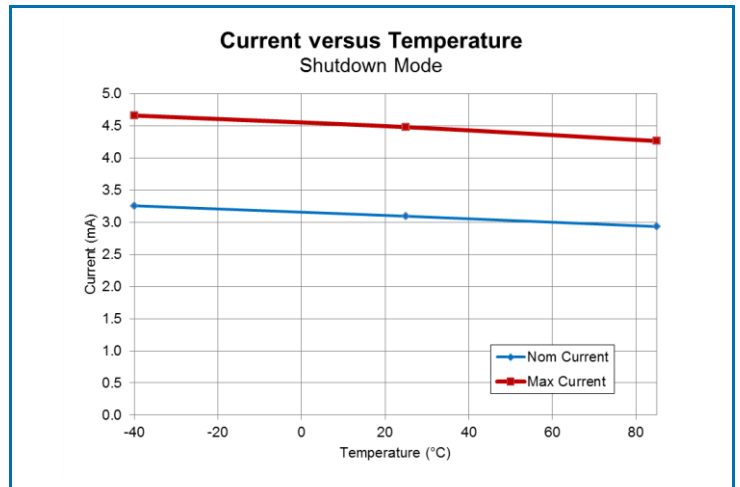
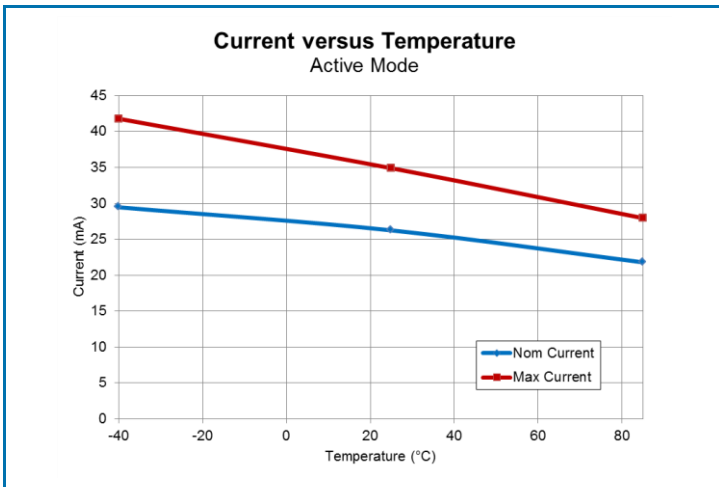
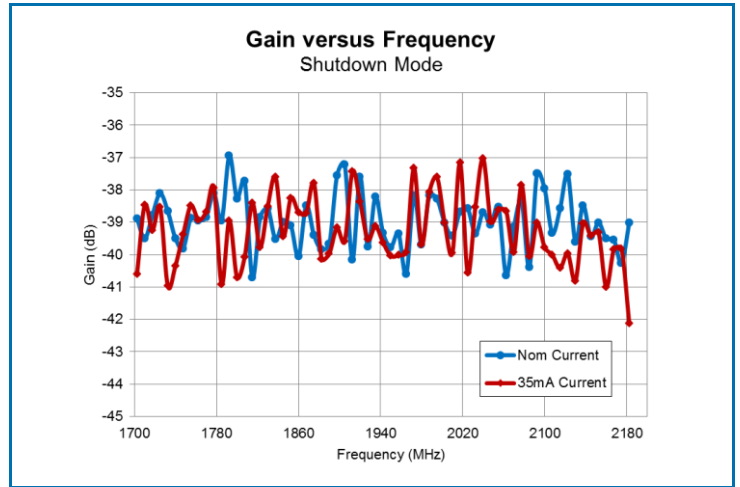
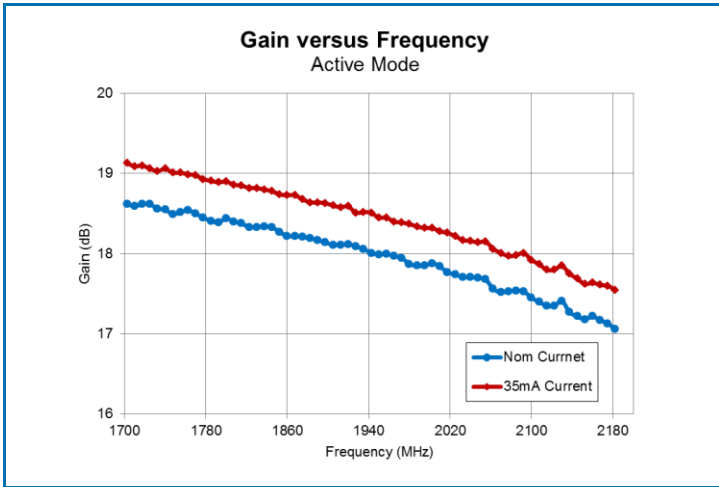

Typical Performance: T=25°C, VDD = 4V unless otherwise noted

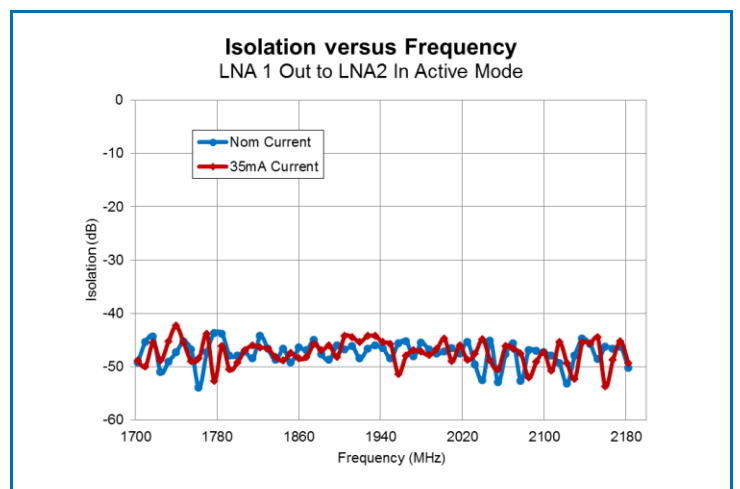
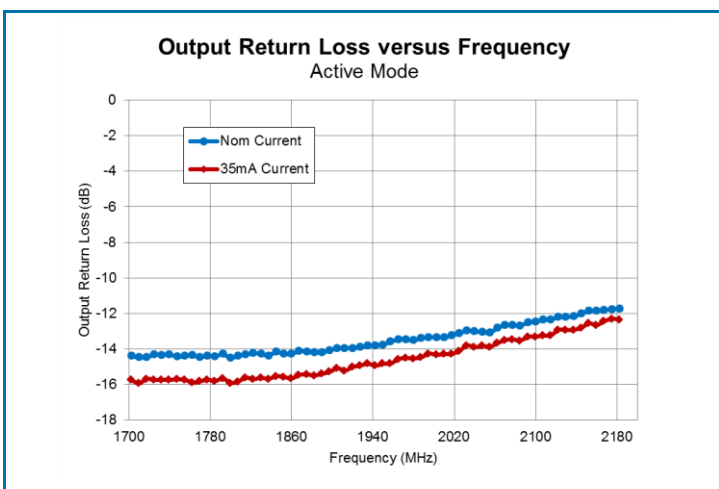
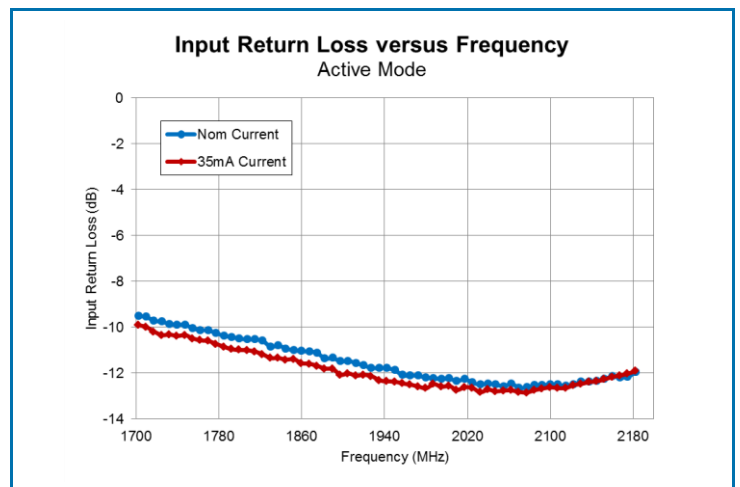
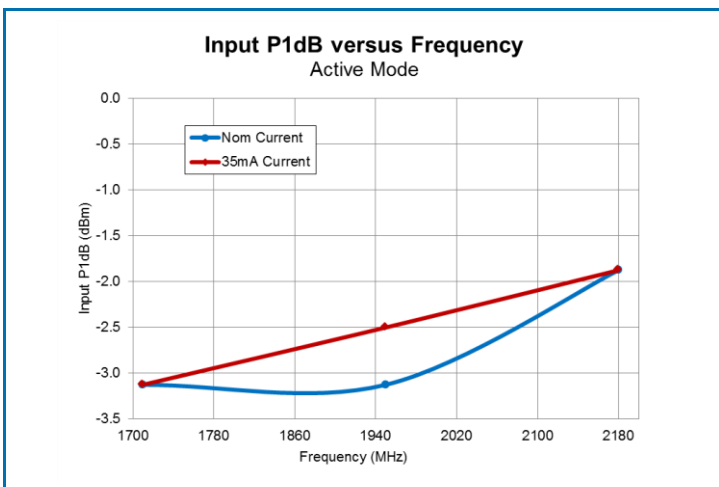
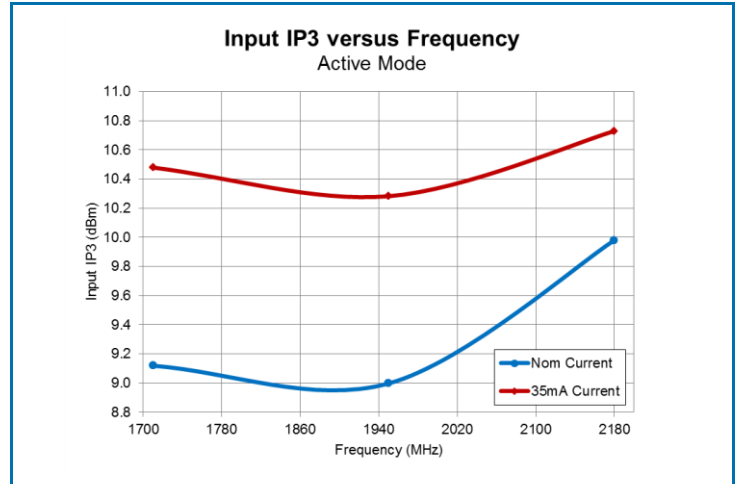
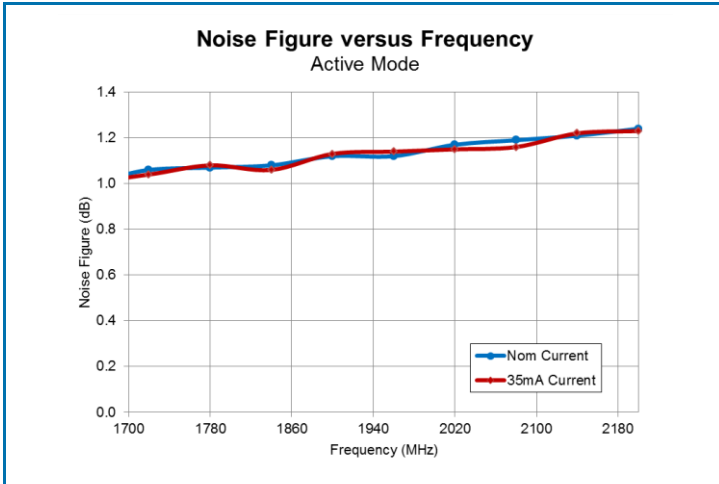

Evaluation Board Schematic

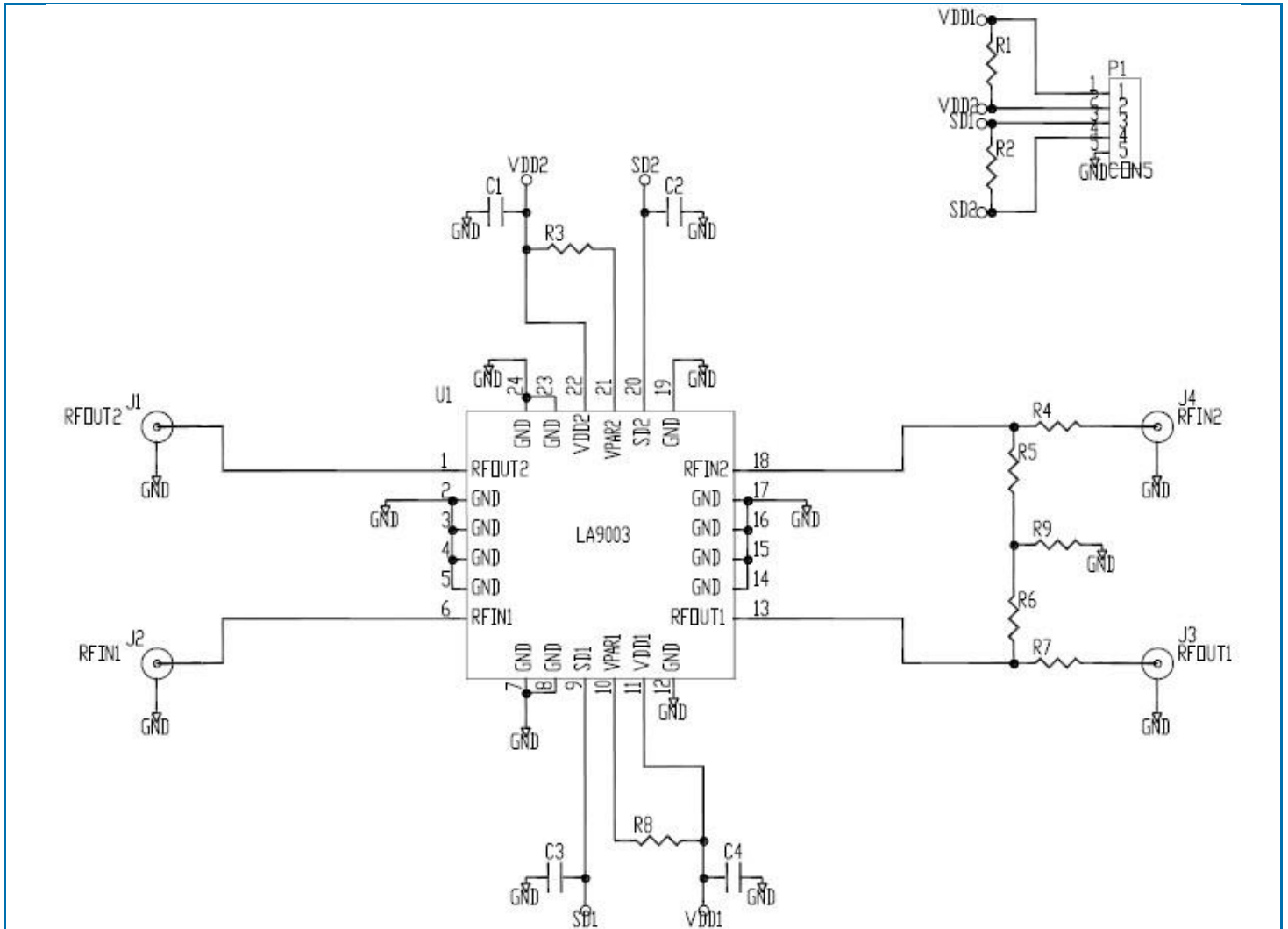

Evaluation Board Bill of Materials (BOM)

Description	Reference Designator	Manufacturer	Manufacturer's P/N
Evaluation Board		DDI	LA9002-410(1)
RFLA9003 Module	U1	RFMD	RFLA9003
CAP, 0.1 μ F, 10% 16V, X7R, 0402	C1-C4	Murata Electronics	GRM155R71C104KA88D
CONN, SMA, END LNCH, UNIV, HYB MNT, FLT	J1-J4	Heilind Electronics	PER MAT-21-9003
RES, 0 Ω , 0402	R5-R6	Kamaya, Inc.	RMC1/16SJPTH
CONN, HDR, ST, PLRZD, 9-PIN	P1	ITW Pancon	MPSS100-5C
DNP	R1-R4*, R7-R9*		

Note: Parts with * following the Reference Designators should not be populated on PCBA.

Evaluation Board Assembly Drawing

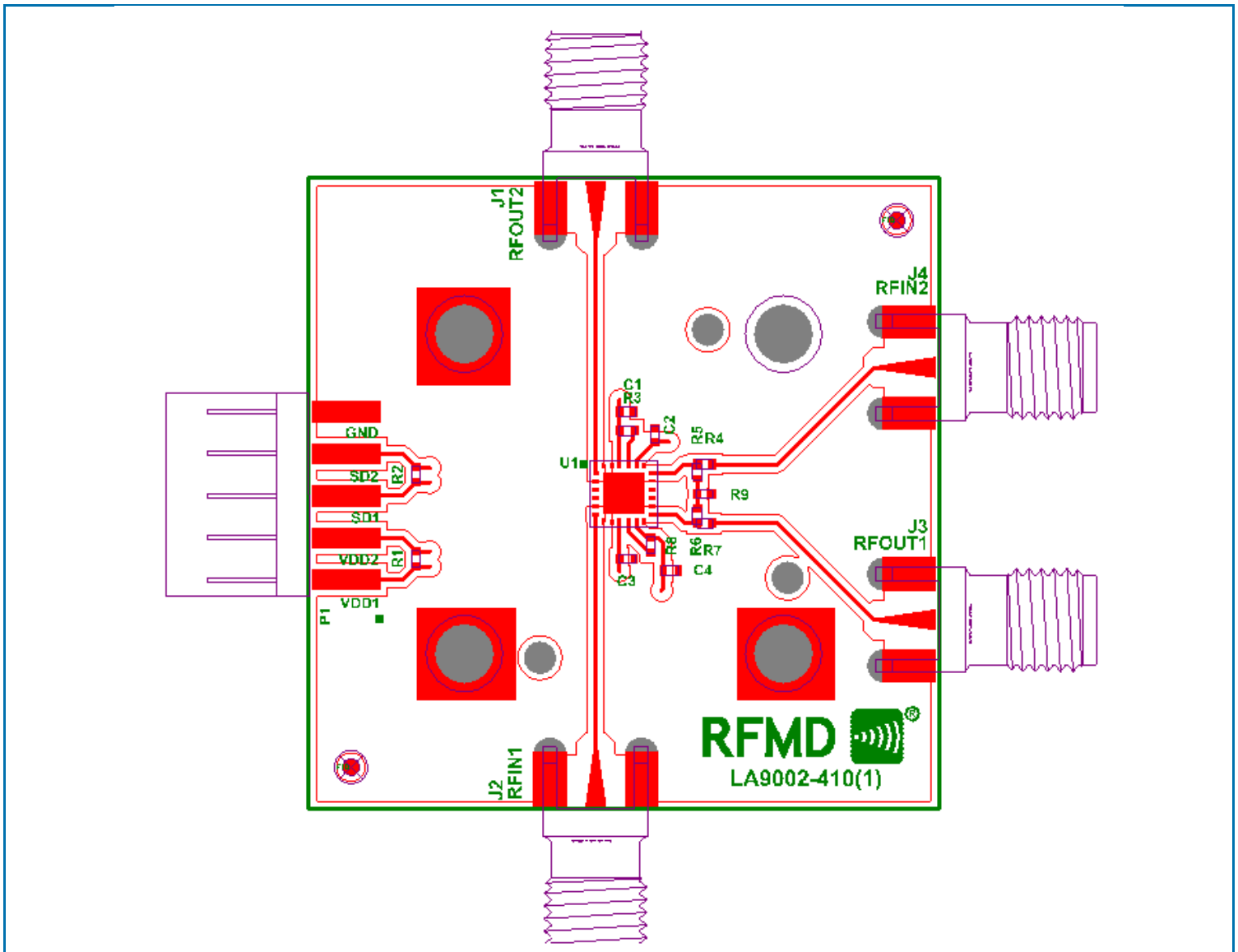

Pin Names and Descriptions

Pin	Name	Description
1	RF_OUT2	RF Output ; Internally 50Ω matched and DC blocked
2	GND	Connect to low inductance path to ground
3	GND	Connect to low inductance path to ground
4	GND	Connect to low inductance path to ground
5	GND	Connect to low inductance path to ground
6	RF_IN1	RF Input; Internally 50Ω matched and DC blocked
7	GND	Connect to low inductance path to ground
8	GND	Connect to low inductance path to ground
9	SD1	Shut down pin for LNA1
10	VPAR1	Connection for external resistor to raise current when connected from this pad to V _{DD} and to lower current when connected from this pad to ground
11	VDD1	VDD Supply, 10nF decoupling internal, supply for LNA1
12	GND	Connect to low inductance path to ground
13	RF_OUT1	RF Output; Internally 50Ω matched and DC blocked
14	GND	Connect to low inductance path to ground
15	GND	Connect to low inductance path to ground
16	GND	Connect to low inductance path to ground
17	GND	Connect to low inductance path to ground
18	RF_IN1	RF Input; Internally 50Ω matched and DC blocked
19	GND	Connect to low inductance path to ground
20	SD2	Shut down pin for LNA2
21	VPAR2	Connection for external resistor to raise current when connected from this pad to V _{DD} and to lower current when connected from this pad to ground
22	VDD2	VDD Supply, 10nF decoupling internal, supply for LNA2
23	GND	Connect to low inductance path to ground
24	GND	Connect to low inductance path to ground

Truth Table

	SD1	SD2
LNA1 On	0	X
LNA1 Off	1	X
LNA2 On	X	0
LNA2 Off	X	1

Package Outline Drawing (Dimensions in millimeters)

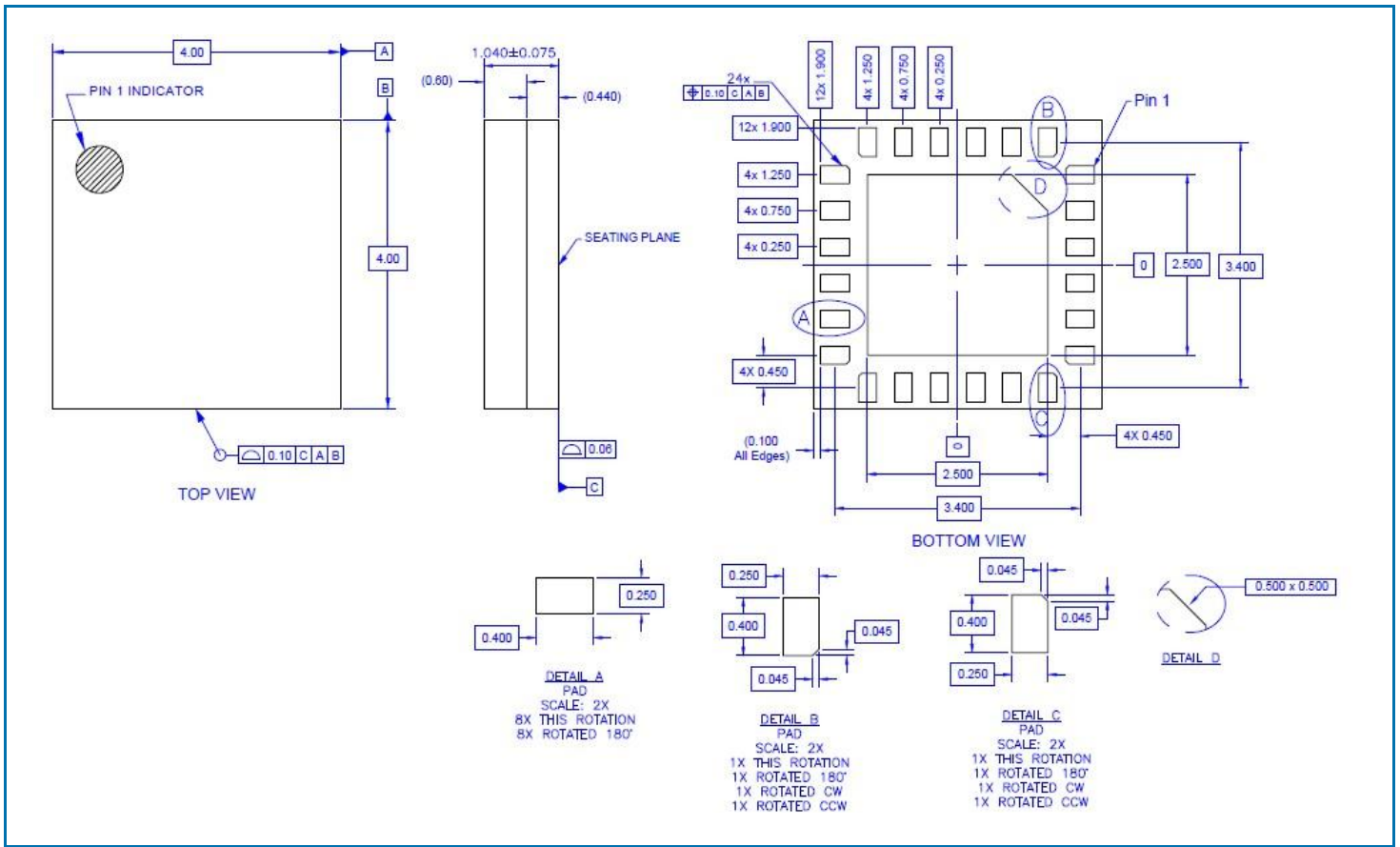

Branding Diagram

