



## UPC817

## PHOTOCOUPLER

### 4 PIN DIP PHOTOTRANSISTOR PHOTOCOUPLER

#### DESCRIPTION

The UTC **UPC817** is a 4 pin DIP phototransistor photocoupler, it uses UTC's advanced technology to provide the customers with high isolation voltage between input and output, etc.

The UTC **UPC817** is suitable for programmable controllers and telecommunication equipments, etc.

#### FEATURES

- \* High isolation voltage between input and output
- \* Creepage distance > 7.62 mm

#### SYMBOL

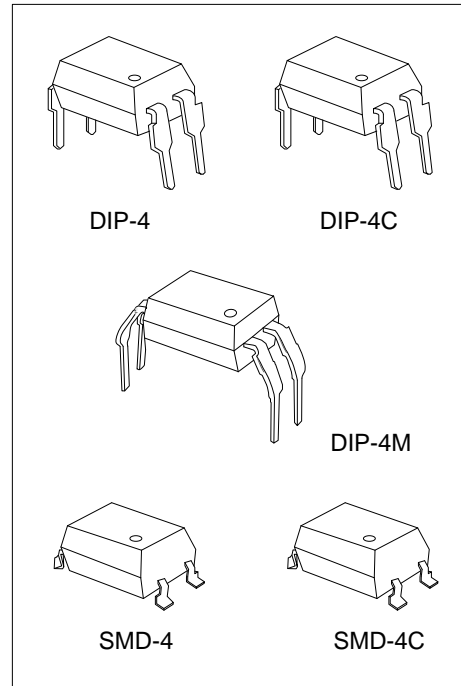
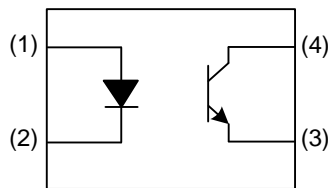

#### ORDERING INFORMATION

Ordering Number		Package	Pin Assignment				Packing
Lead Free	Halogen Free		1	2	3	4	
UPC817L-C04-R	UPC817G-C04-R	SMD-4	A	K	E	C	Tape Reel
UPC817xL-C04-R	UPC817xG-C04-R	SMD-4	A	K	E	C	Tape Reel
UPC817L-C04C-R	UPC817G-C04C-R	SMD-4C	A	K	E	C	Tape Reel
UPC817xL-C04C-R	UPC817xG-C04C-R	SMD-4C	A	K	E	C	Tape Reel
UPC817L-D04-T	UPC817G-D04-T	DIP-4	A	K	E	C	Tube
UPC817xL-D04-T	UPC817xG-D04-T	DIP-4	A	K	E	C	Tube
UPC817L-D04C-T	UPC817G-D04C-T	DIP-4C	A	K	E	C	Tube
UPC817xL-D04C-T	UPC817xG-D04C-T	DIP-4C	A	K	E	C	Tube
UPC817L-D04M-T	UPC817G-D04M-T	DIP-4M	A	K	E	C	Tube
UPC817xL-D04M-T	UPC817xG-D04M-T	DIP-4M	A	K	E	C	Tube

Note: Pin Assignment: A: Anode K: Cathode E: Emitter C: Collector

<p>UPC817xG-C04-R</p>	<p>(1) R: Tape Reel, T: Tube                  (2) C04: SMD-4, C04C: SMD-4C, D04: DIP-4                  D04C: DIP-4C, D04M: DIP-4M                  (3) G: Halogen Free and Lead Free, L: Lead Free                  (4) Refer to TRANSFER CHARACTERISTICS</p>
-----------------------	--

■ MARKING

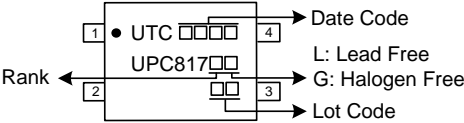

■ **ABSOLUTE MAXIMUM RATING** ( $T_A=25^{\circ}\text{C}$ , unless otherwise specified)

PARAMETER		SYMBOL	RATINGS	UNIT
Input	Forward Current	$I_F$	60	mA
	Peak Forward Current (1 $\mu\text{s}$ , Pulse)	$I_{FP}$	1	A
	Reverse Voltage	$V_R$	6	V
	Power Dissipation	$P_D$	100	mW
	Derating Factor		1	mW/ $^{\circ}\text{C}$
Output	Power Dissipation	$P_C$	150	mW
	Derating Factor		1.5	mW/ $^{\circ}\text{C}$
	Collector Current	$I_C$	50	mA
	Collector-Emitter Voltage	$V_{CEO}$	35	V
	Emitter-Collector Voltage	$V_{ECO}$	6	V
Total Power Dissipation		$P_D$	200	mW
Isolation Voltage (Note 2)		$V_{ISO}$	5000	V <sub>rms</sub>
Operating Temperature		$T_{OPR}$	-55 ~ +110	$^{\circ}\text{C}$
Storage Temperature		$T_{STG}$	-55 ~ +125	$^{\circ}\text{C}$

Notes: 1. Absolute maximum ratings are those values beyond which the device could be permanently damaged. Absolute maximum ratings are stress ratings only and functional device operation is not implied.  
 2. AC for 1 minute, R.H.= 40~60% R.H. In this test, pins 1, 2 are shorted together, and pins 3, 4 are shorted together.

■ **ELECTRICAL CHARACTERISTICS** ( $T_A=25^{\circ}\text{C}$ , unless otherwise specified)

PARAMETER	SYMBOL	TEST CONDITIONS	MIN	TYP	MAX	UNIT
<b>INPUT</b>						
Forward Voltage	$V_F$	$I_F=20\text{mA}$		1.2	1.4	V
Reverse Current	$I_R$	$V_R=4\text{V}$			10	$\mu\text{A}$
Input Capacitance	$C_{IN}$	$V=0, f=1\text{kHz}$		30	250	pF
<b>OUTPUT</b>						
Collector-Emitter Dark Current	$I_{CEO}$	$V_{CE}=20\text{V}, I_F=0\text{mA}$			100	nA
Collector-Emitter Breakdown Voltage	$BV_{CEO}$	$I_C=0.1\text{mA}$	35			V
Emitter-Collector Breakdown Voltage	$BV_{ECO}$	$I_E=0.1\text{mA}$	6			V

■ **TRANSFER CHARACTERISTICS** ( $T_A=25^{\circ}\text{C}$ , unless otherwise specified)

PARAMETER	SYMBOL	TEST CONDITIONS	MIN	TYP	MAX	UNIT	
Current Transfer Ratio	CTR	$I_F=5\text{mA}, V_{CE}=5\text{V}$	UPC817	50		600	%
			UPC817A	80		160	%
			UPC817B	130		260	%
			UPC817C	200		400	%
			UPC817D	300		600	%
			UPC817X	100		200	%
			UPC817Y	150		300	%
Collector-Emitter Saturation Voltage	$V_{CE(sat)}$	$I_F=20\text{mA}, I_C=1\text{mA}$		0.1	0.2	V	
Isolation Resistance	$R_{IO}$	$V_{IO}=500\text{Vdc}, 40\sim 60\% \text{ R.H.}$	$5 \times 10^{10}$			$\Omega$	
Floating Capacitance	$C_{IO}$	$V_{IO}=0, f=1\text{MHz}$		0.6	1.0	pF	
Cut-Off Frequency	$f_c$	$V_{CE}=5\text{V}, I_C=2\text{mA}, R_L=100\Omega, -3\text{dB}$		80		kHz	
Rise Time	$t_R$	$V_{CE}=2\text{V}, I_C=2\text{mA}, R_L=100\Omega$		4	18	$\mu\text{s}$	
Fall Time	$t_F$			3	18	$\mu\text{s}$	

## ■ TEST CIRCUITS AND WAVEFORMS

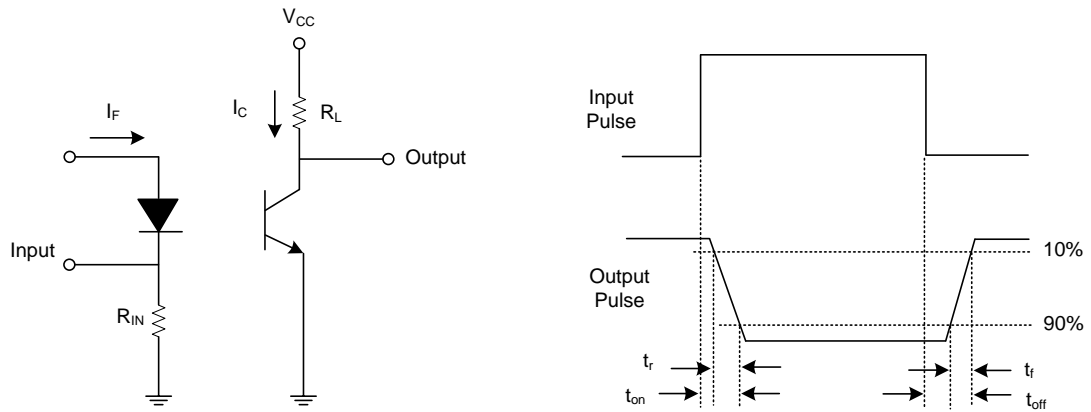

Switching Time Test Circuit & Waveforms

## ■ TYPICAL CHARACTERISTICS

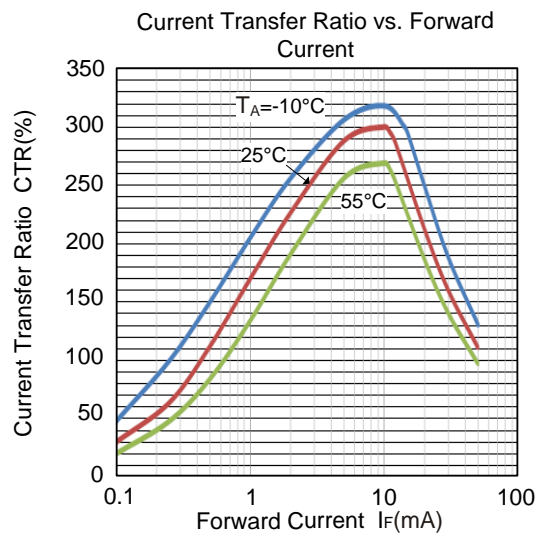
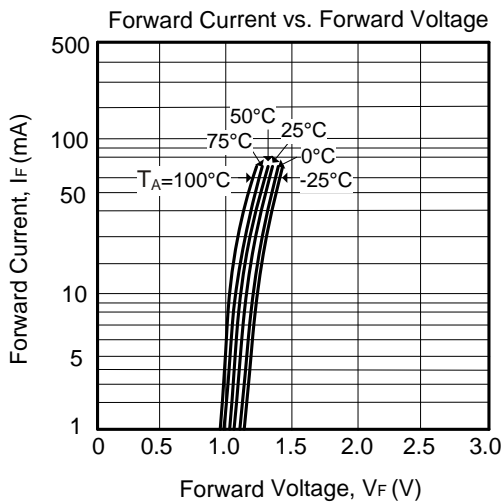
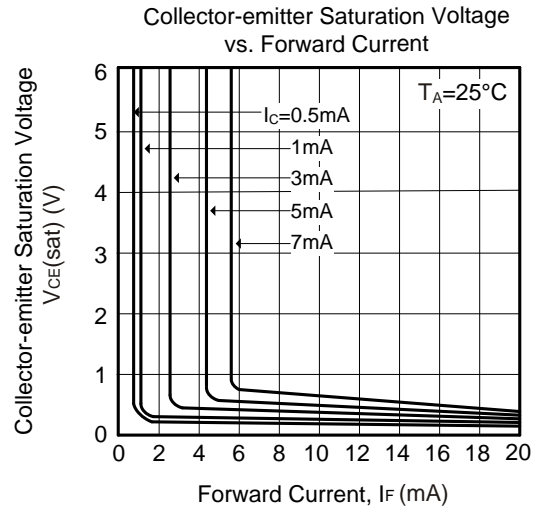
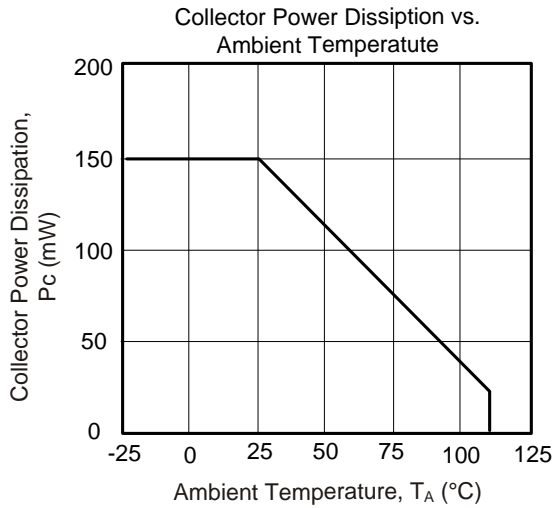
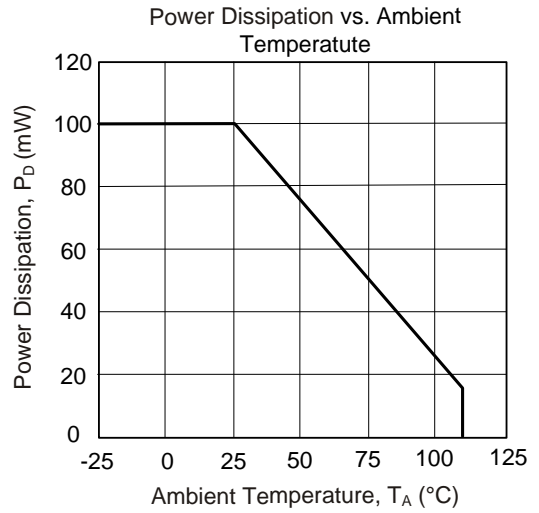
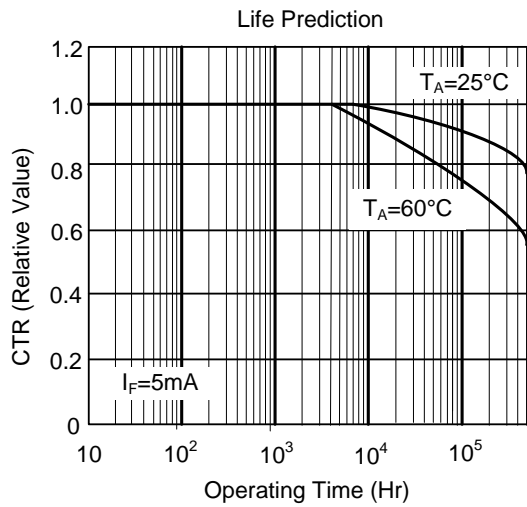

## ■ TYPICAL CHARACTERISTICS

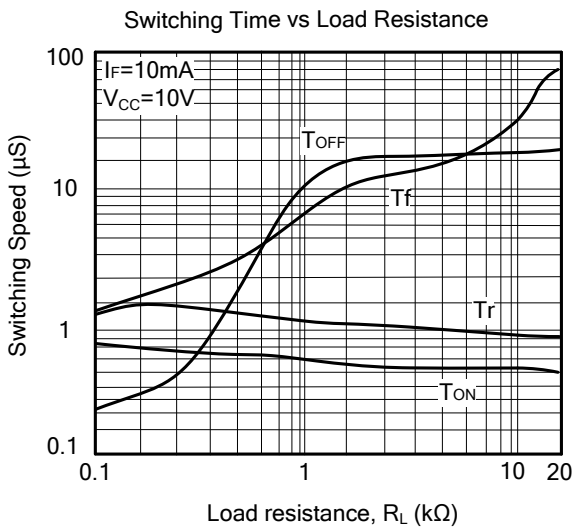
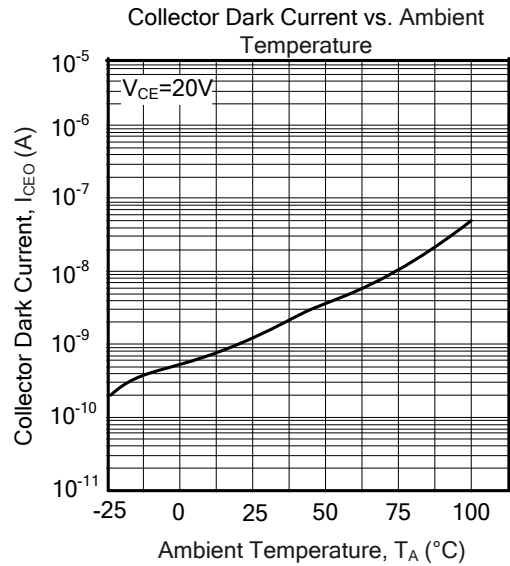
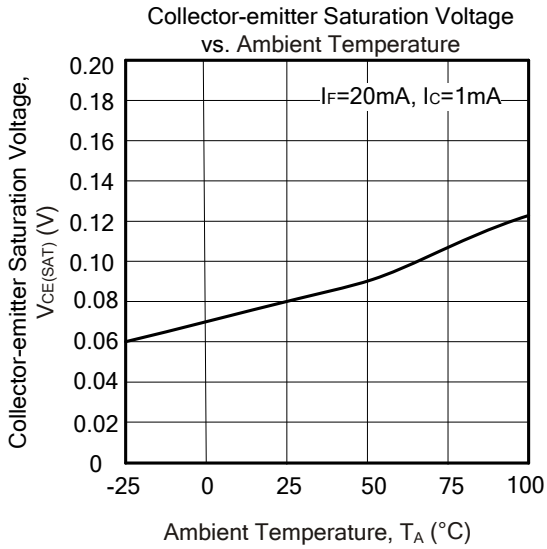
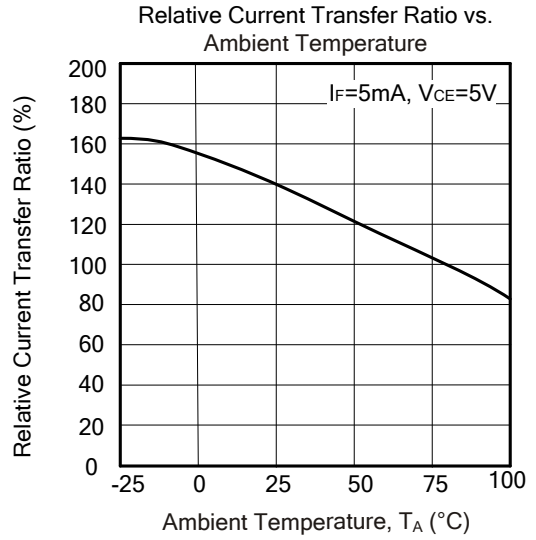
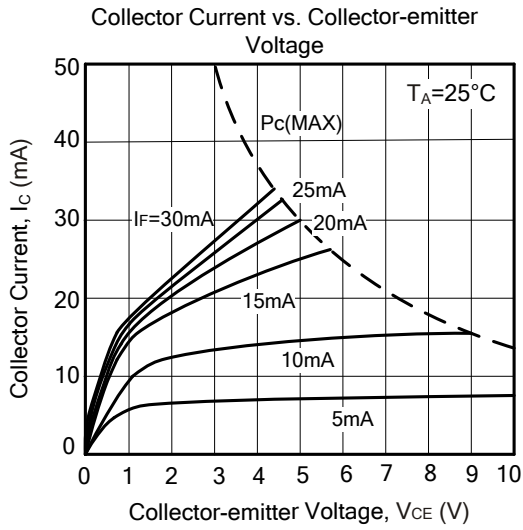

UTC assumes no responsibility for equipment failures that result from using products at values that exceed, even momentarily, rated values (such as maximum ratings, operating condition ranges, or other parameters) listed in products specifications of any and all UTC products described or contained herein. UTC products are not designed for use in life support appliances, devices or systems where malfunction of these products can be reasonably expected to result in personal injury. Reproduction in whole or in part is prohibited without the prior written consent of the copyright owner. UTC reserves the right to make changes to information published in this document, including without limitation specifications and product descriptions, at any time and without notice. This document supersedes and replaces all information supplied prior to the publication hereof.