

17 – 37 GHz MPA/Multiplier

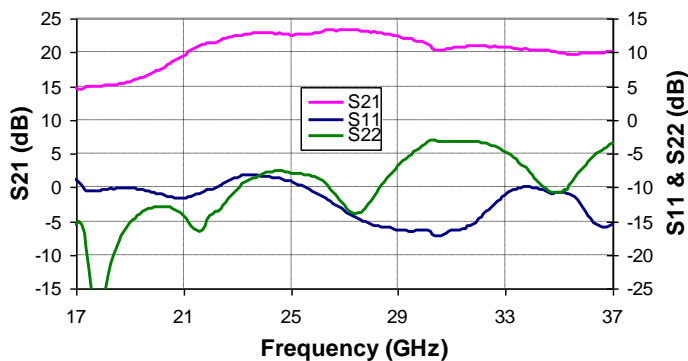

Measured Performance

Bias at $V_d = 5V$, $I_d = 140mA$ and $V_g = -0.75V$ (Typical)



Bias at $V_d = 5V$, $I_d = 140mA$ and $V_g = -0.75V$ (Typical)

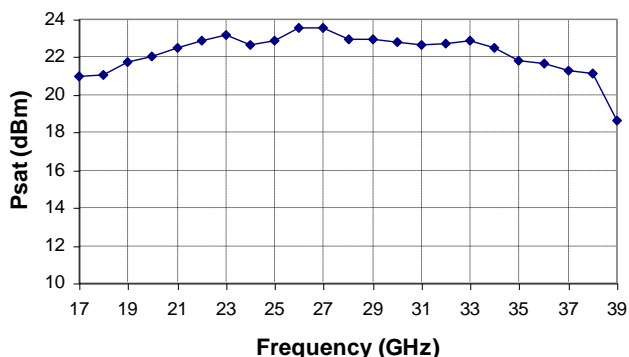

Key Features

- RF Output Frequency Range: 17 - 37 GHz
- 20 dB Nominal Gain
- 22 dBm Nominal Output Maximum Power
- 2x and 3x Multiplier Function
- Bias: $V_d = 5V$, $I_d = 140mA$
- Package Dimensions: 3.0 x 3.0 x 1.1 mm

Primary Applications

- Point-to-Point Radio
- EW
- Instrumentation
- Frequency Multiplier

Product Description

The TriQuint TGA4030-SM is a Medium Power Amplifier and Multiplier for wide band 17 – 37 GHz applications. The part is designed using TriQuint's 0.15um power pHEMT process.

The TGA4030-SM provides a nominal 20 dB small signal gain with 22 dBm maximum output power. For 2x and 3x Multiplier Function, TGA4030-SM provides 15 dBm typical output power @ 9 dBm Pin.

This part is ideally suited for applications such as Point-to-Point Radio, EW, instrumentation and frequency multipliers.

Evaluation boards are available upon request.

Lead-free and RoHS compliant

Datasheet subject to change without notice.

Table I
Absolute Maximum Ratings 1/

Symbol	Parameter	Value	Notes
Vd-Vg	Drain to Gate Voltage range	8V	
Vd	Drain Supply Voltage Range	6 V	
Vg	Gate Supply Voltage Range	-3 – 0 V	
Id	Drain Current	400 mA	
Ig	Gate Current	1.38 mA	
Pin	Input Continuous Wave Power	20 dBm	

1/ These ratings represent the maximum operable values for this device. Stresses beyond those listed under “Absolute Maximum Ratings” may cause permanent damage to the device and / or affect device lifetime. These are stress ratings only, and functional operation of the device at these conditions is not implied.

Table II
Recommended Operating Conditions

Symbol	Parameter	Value
Vd	Drain Voltage	5 V
Id	Drain Current	140 mA
Vg	Gate Voltage (Typical)	-0.75 V
Vd1	Drain Voltage	1 V
Vg1	Gate Voltage	-1.1 V

See bias plan on page 14 for amplifier and 2x multiplier, page 15 for 3x multiplier

Table III
RF Characterization Table

Bias: Vd=5V, Id= 140mA, Vg = -0.75V (typical), T_A= 25 °C

PARAMETER	AMPLIFIER	2X MULTIPLIER	3x MULTIPLIER	UNITS
RF Output Frequencies	17 - 37	22 - 38	23 - 31	GHz
S21, Small Signal Gain	20	-	-	dB
S11, Input Return Loss	10	-	-	dB
S22, Output Return Loss	5	5	5	dB
Psat, Maximum Output Power	22			dBm
P1dB, Output Power @ 1 dB Gain Compression	18			dBm
IMD3@ 11 dBm Pout/Tone	30			dBc
Output Power @ Pin = 9 dBm	-	15	15	dBm
Conversion Gain	-	9	5	dB
Gain Temperature coefficient	-0.04			dB/°C

Table IV Power Dissipation and Thermal Properties

Parameter	Test Conditions	Value	Notes
Maximum Power Dissipation	Tbaseplate = 70 °C	Pd = 1.2 W Tchannel = 150 °C Tm = 1.0E+6 Hrs	1/ 2/
Thermal Resistance, θ_{jc}	Vd = 5V Id = 140mA Pd = 0.7W	θ_{jc} = 66.7 (°C/W) Tchannel = 116 °C Tm = 2.4E+7 Hrs	
Mounting Temperature	30 seconds	260 °C Max	
Storage Temperature		-65 to 150 °C	

- 1/ For a median life, Tm, of 1E+6 hours, power dissipation is limited to

$$Pd(max) = (Tchannel\text{ }^{\circ}C - Tbase\text{ }^{\circ}C) / \theta_{jc}.$$
- 2/ Channel operating temperature will directly affect the device median time to failure (MTTF). For maximum life, it is recommended that channel temperatures be maintained at the lowest possible levels.

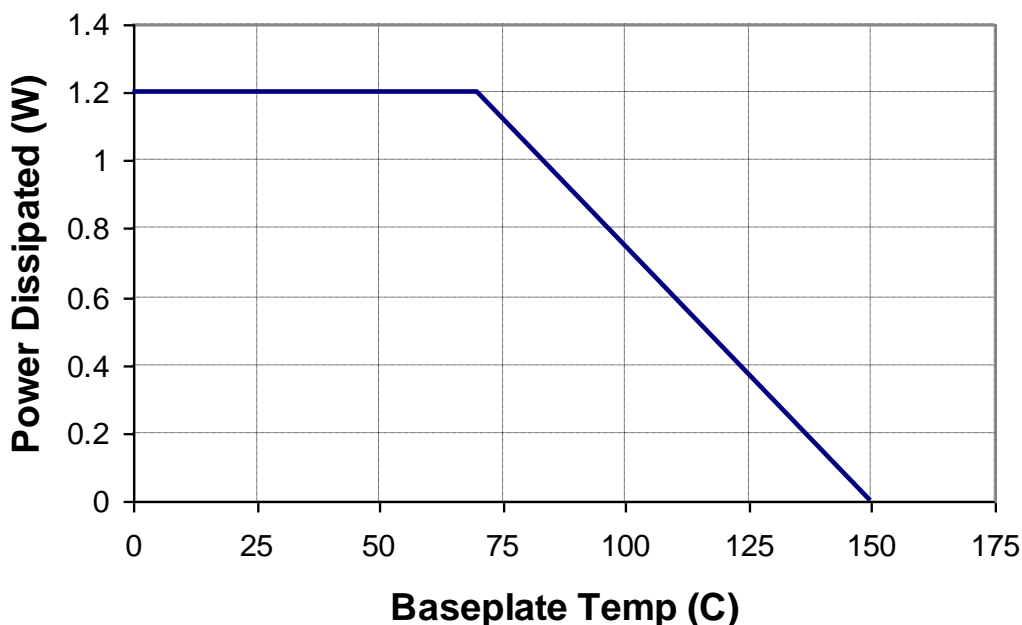

Measured Data

Bias Conditions: $V_d = 5V$, $I_{dq} = 140\text{ mA}$, $V_g = -0.75\text{ V}$ (Typical)

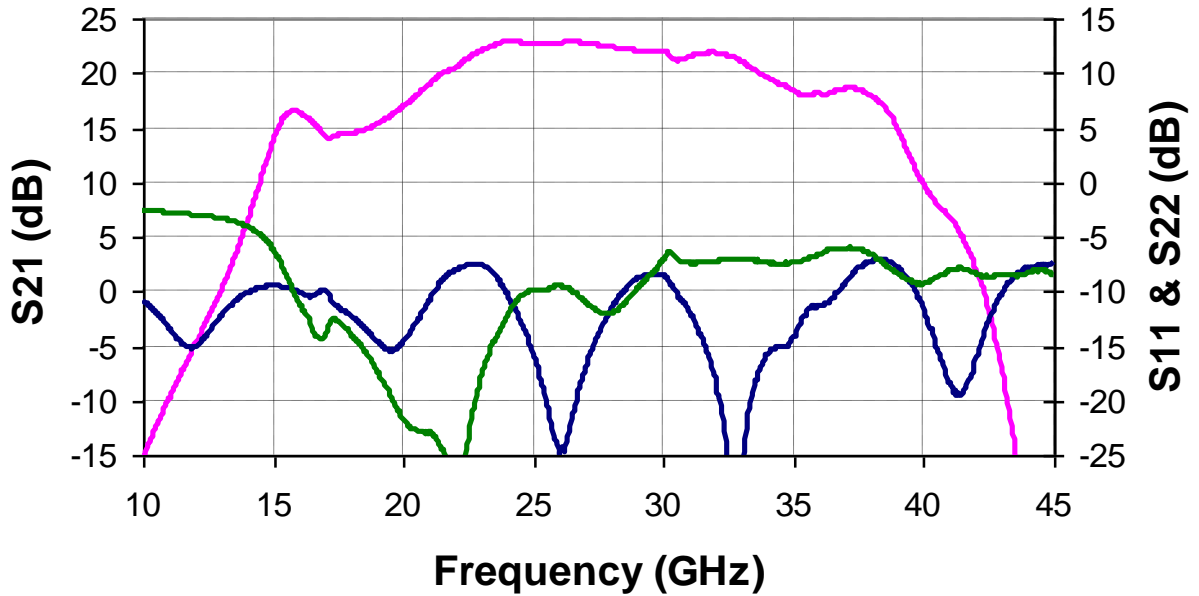

This is device s-parameter

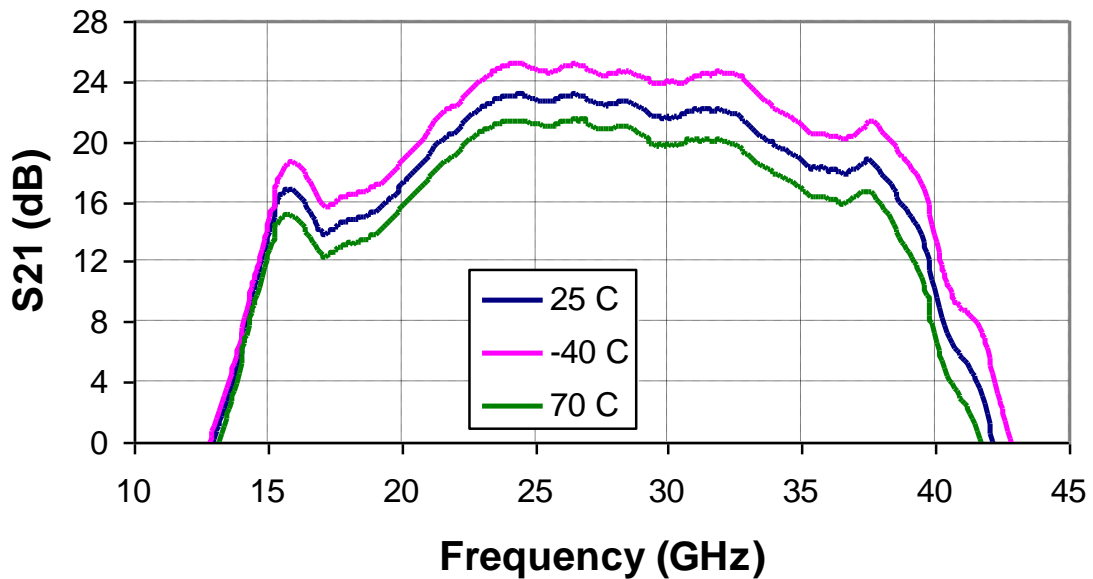

This is evaluation board s-parameter

Measured Data

Bias Conditions: $V_d = 5V$, $I_{dq} = 140\text{ mA}$, $V_g = -0.75\text{ V}$ (Typical)

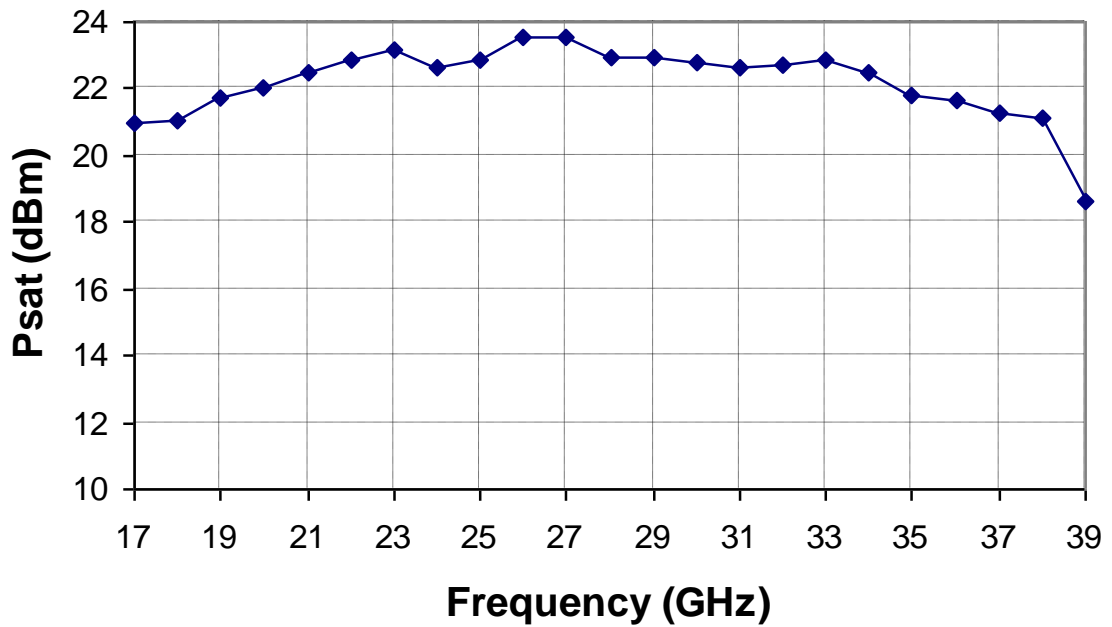
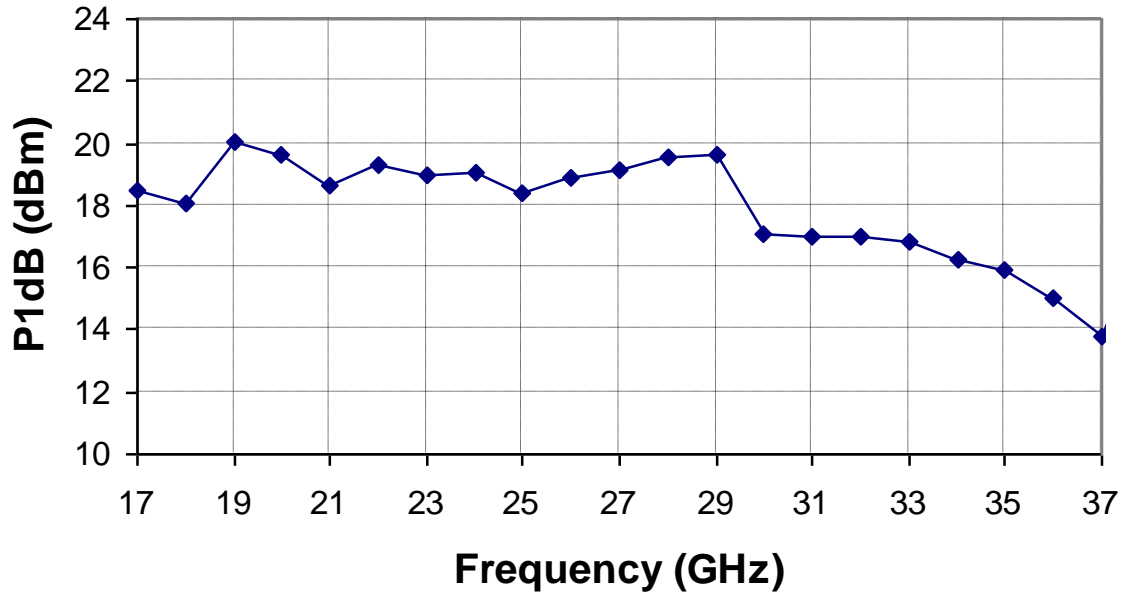

Measured Data

Bias Conditions: $V_d = 5V$, $I_{dq} = 140\text{ mA}$, $V_g = -0.75\text{ V}$ (Typical)

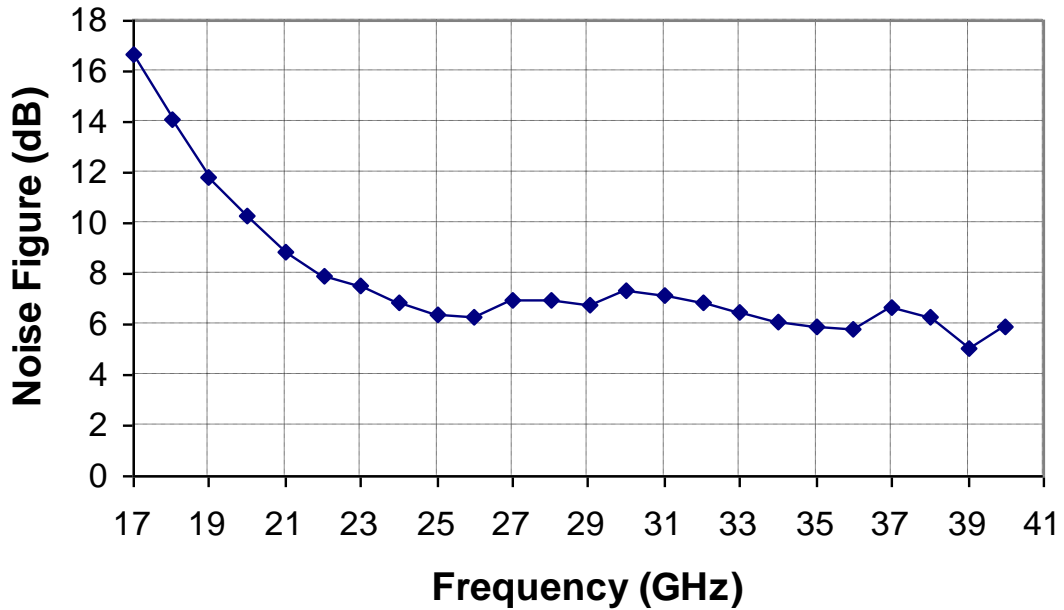
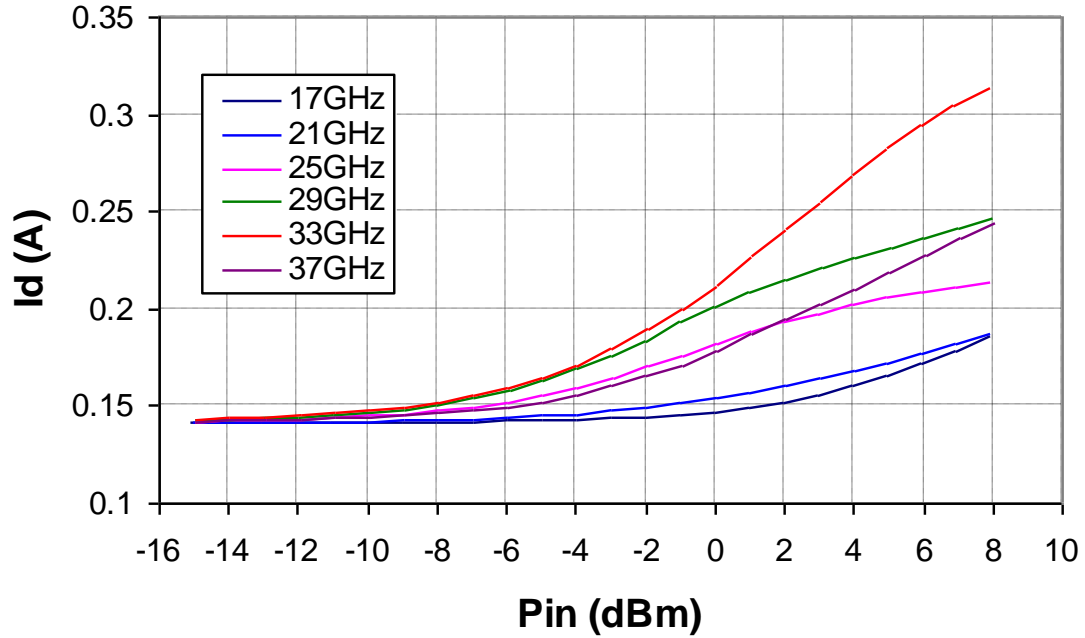

Measured Data

Bias Conditions: $V_d = 5V$, $I_{dq} = 140\text{ mA}$, $V_g = -0.75\text{ V}$ (Typical)

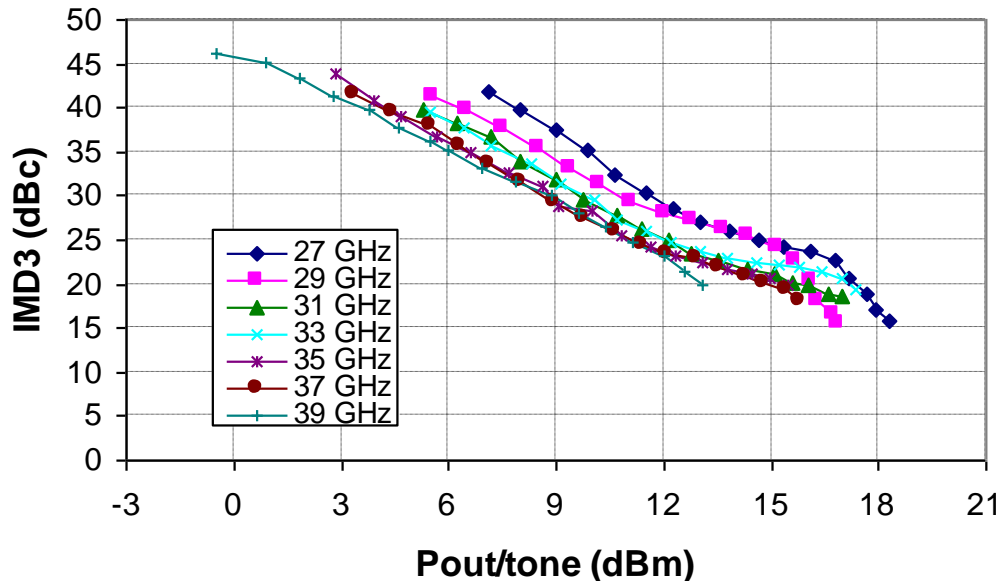
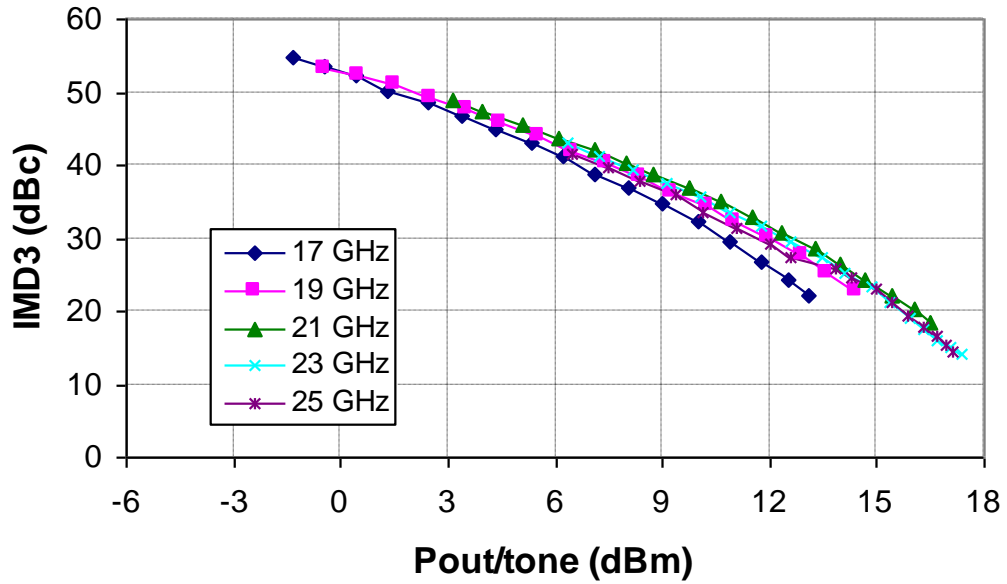

Measured Data

Bias Conditions: $V_d = 5V$, $I_{dq} = 140\text{ mA}$, $V_g = -0.75\text{ V}$ (Typical)

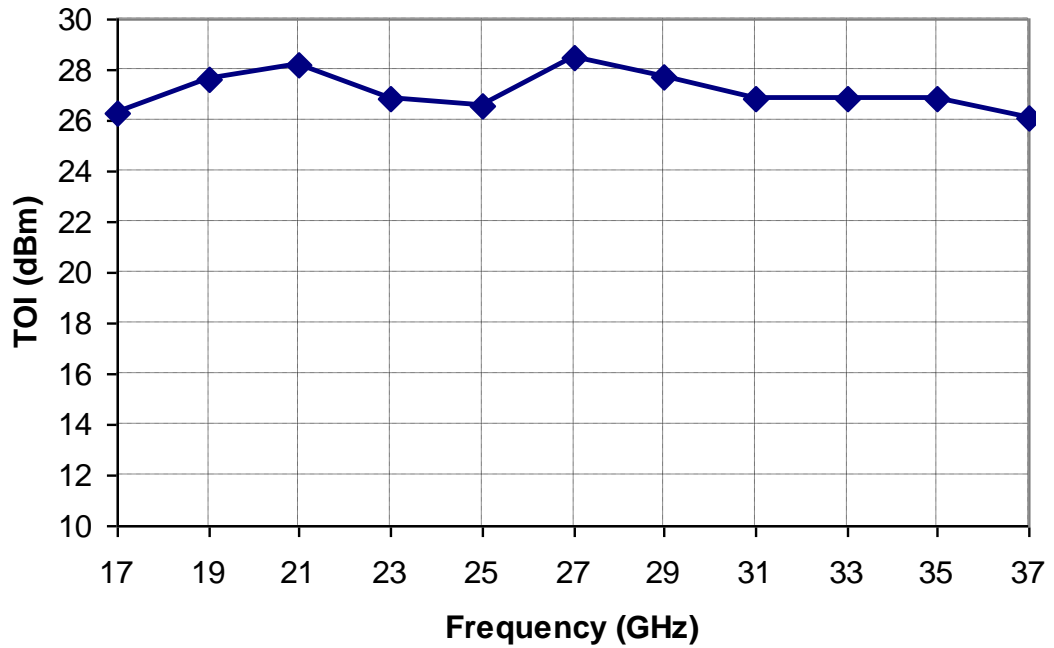

Measured 2X Multiplier Data

Bias Conditions: $V_d = 5\text{ V}$, $I_{dq} = 120\text{ mA}$, $V_{g1} = -1.1\text{ V}$, $P_{in} = 9\text{ dBm}$

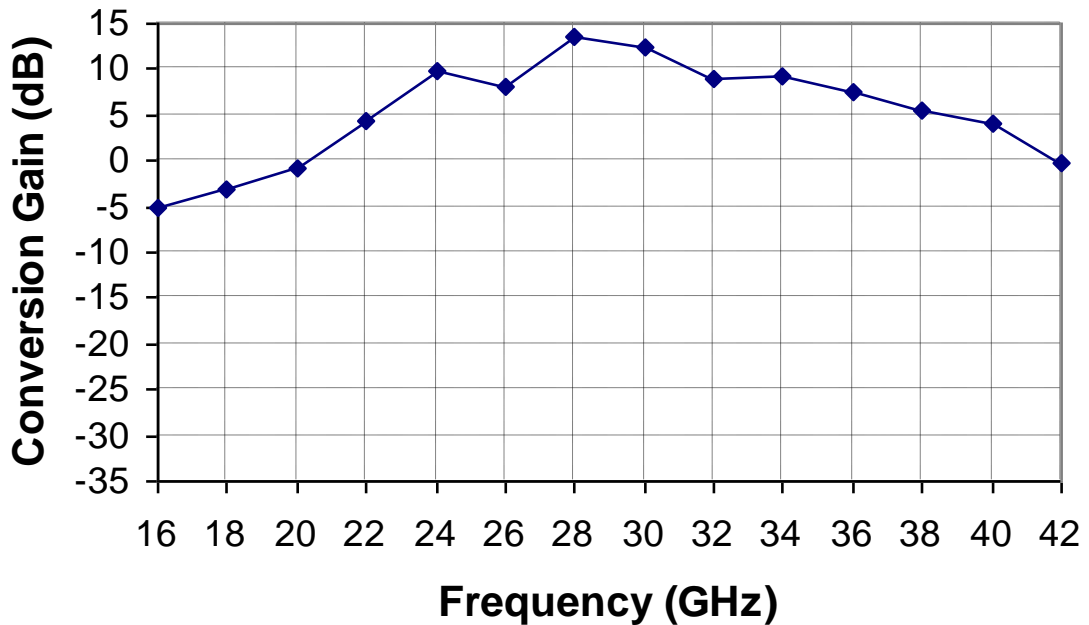
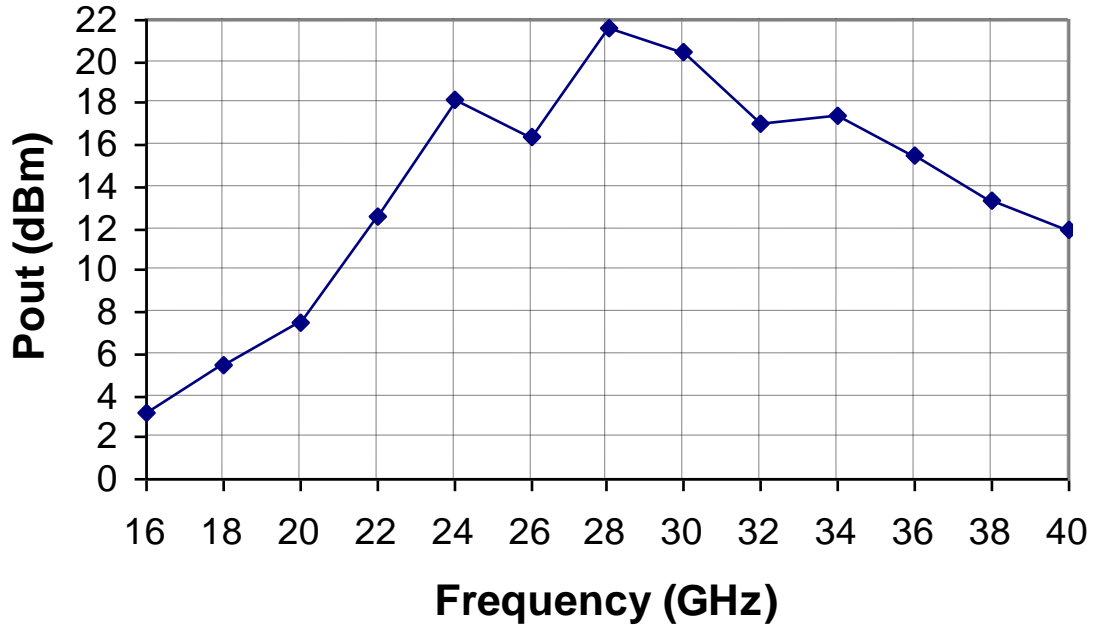

Measured 3X Multiplier Data

Bias Conditions: $V_d = 5\text{ V}$, $V_{d1} = 1\text{ V}$, $I_{dq} = 160\text{ mA}$, $P_{in} = 9\text{ dBm}$

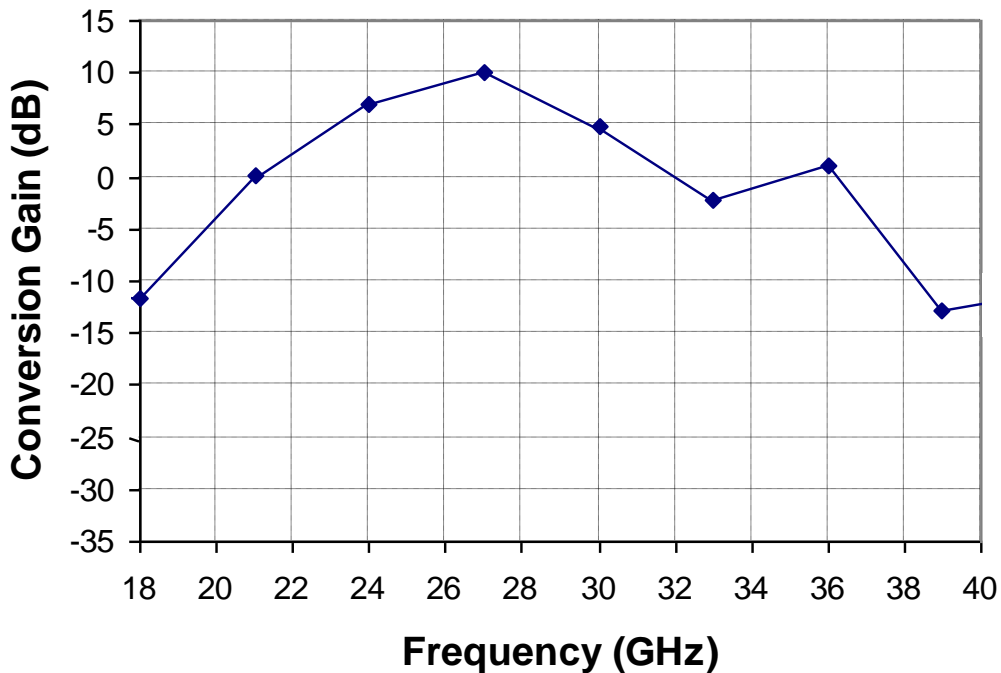
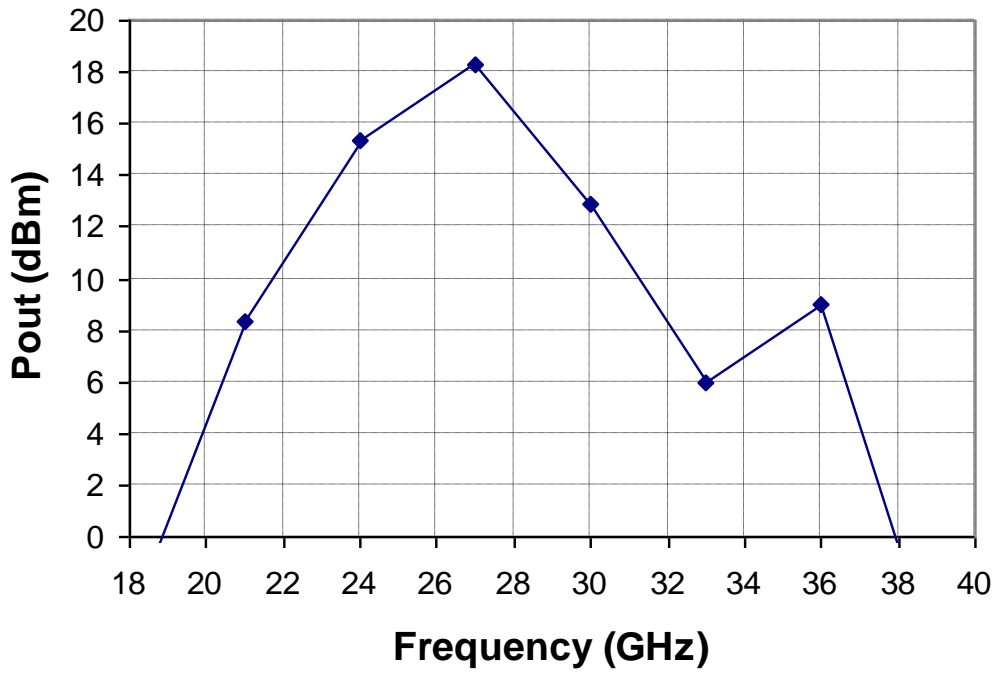

Mechanical Drawing

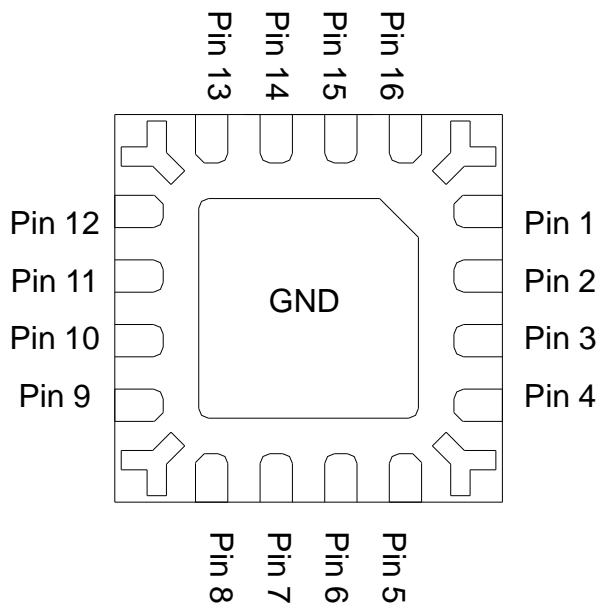

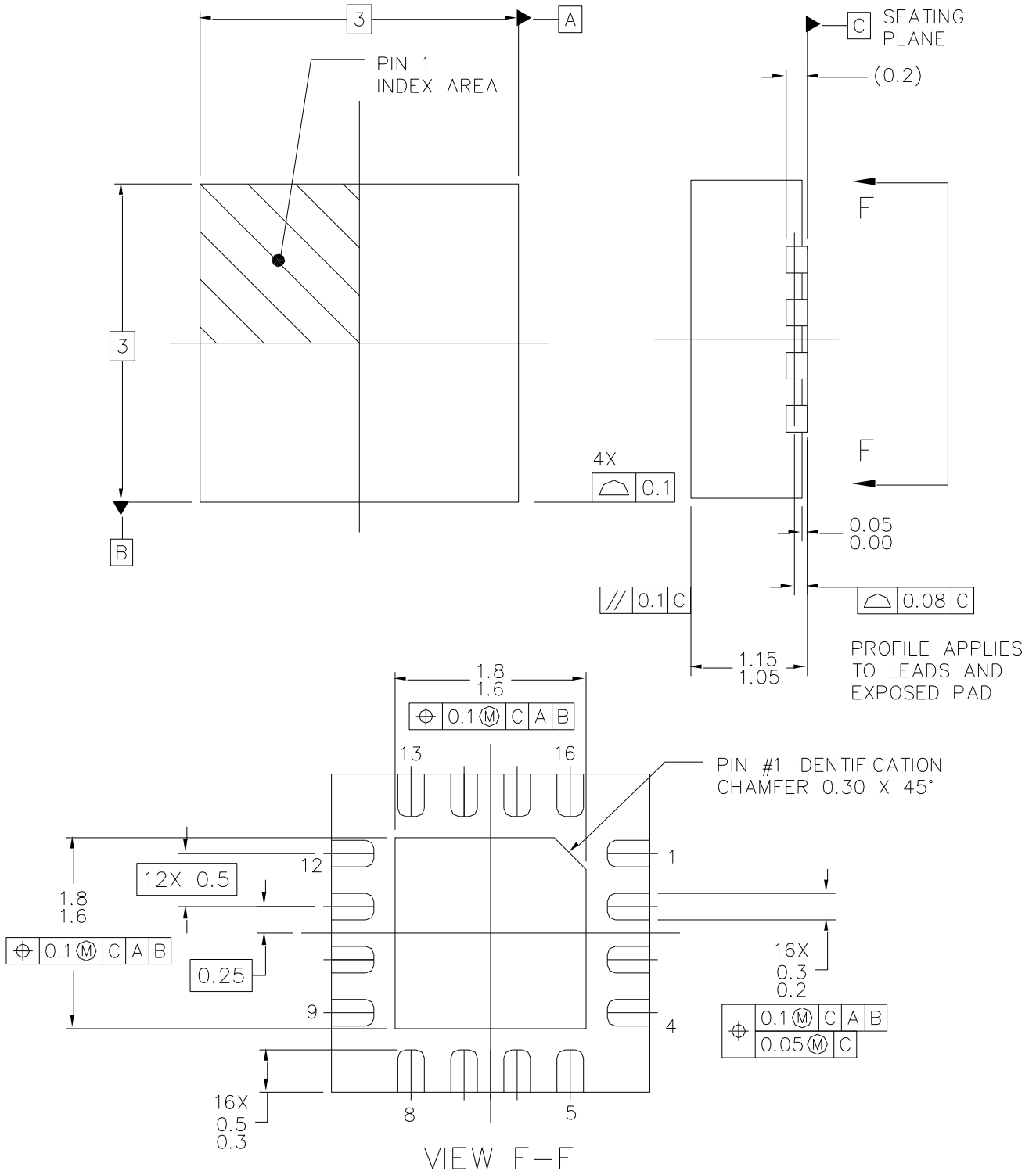

Pin	Description	Pin	Description
1, 2, 4, 9, 11,12	GND	7	Vg
3	RF IN	10	RF OUT
5	Vg1	14	Vd
6, 8, 13, 15	N/C	16	Vd1

GaAs MMIC devices are susceptible to damage from Electrostatic Discharge. Proper precautions should be observed during handling, assembly and test.

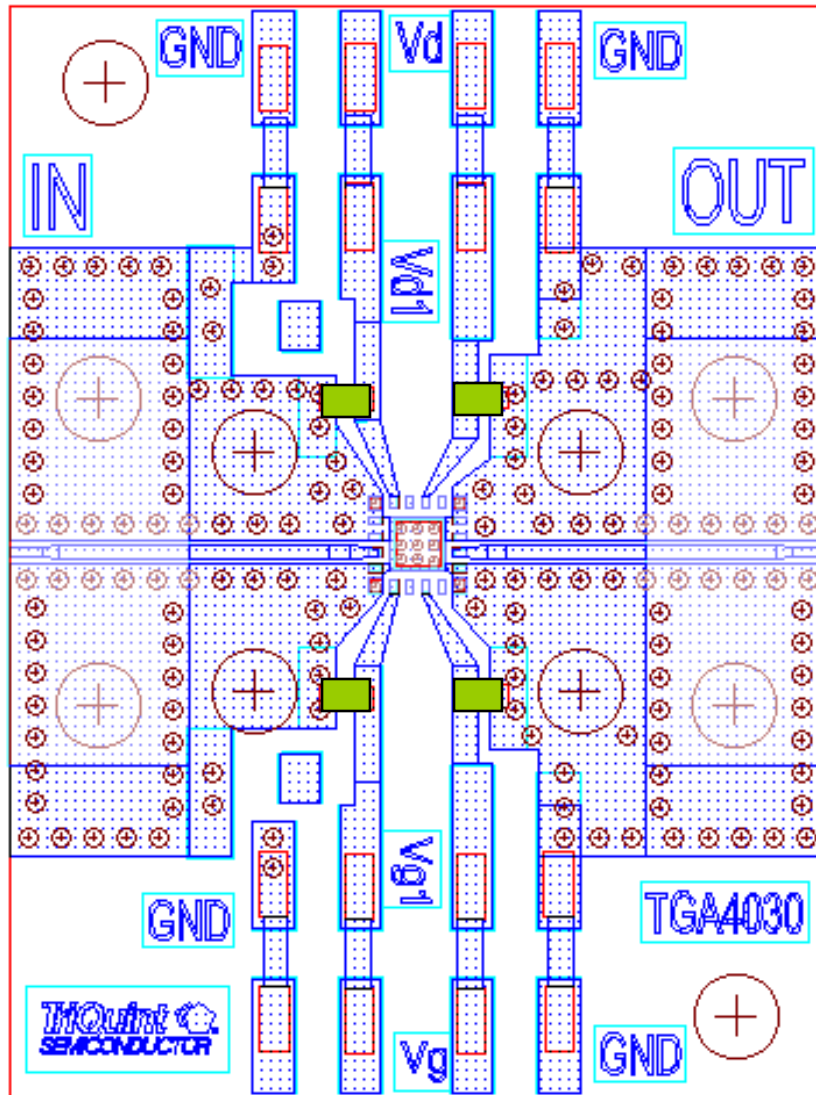

Evaluation Board



 0402 0.01 uF capacitors

Board material is 8 mil ROGERS RO4003

Recommended Power Supply Connection Diagram

Amplifier & 2X Multiplier

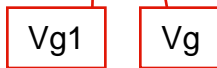
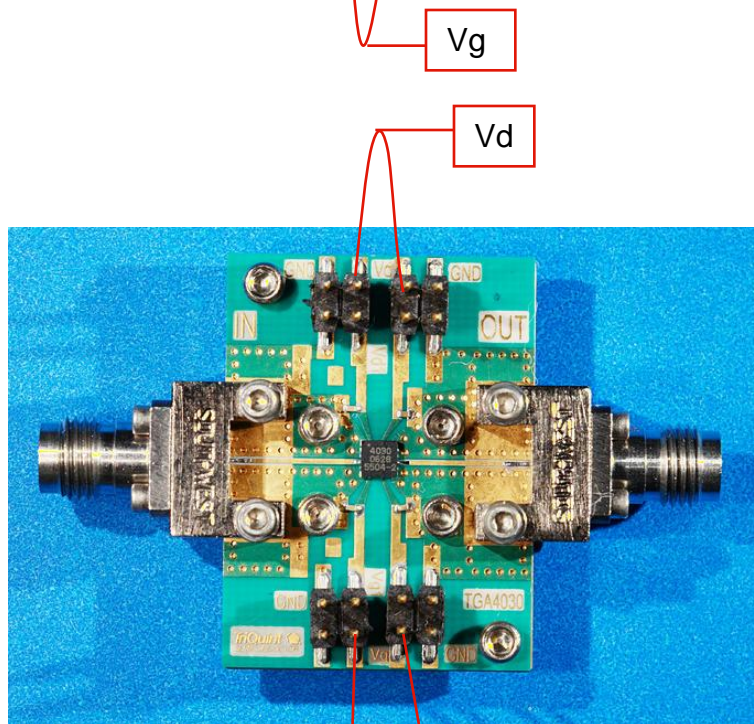
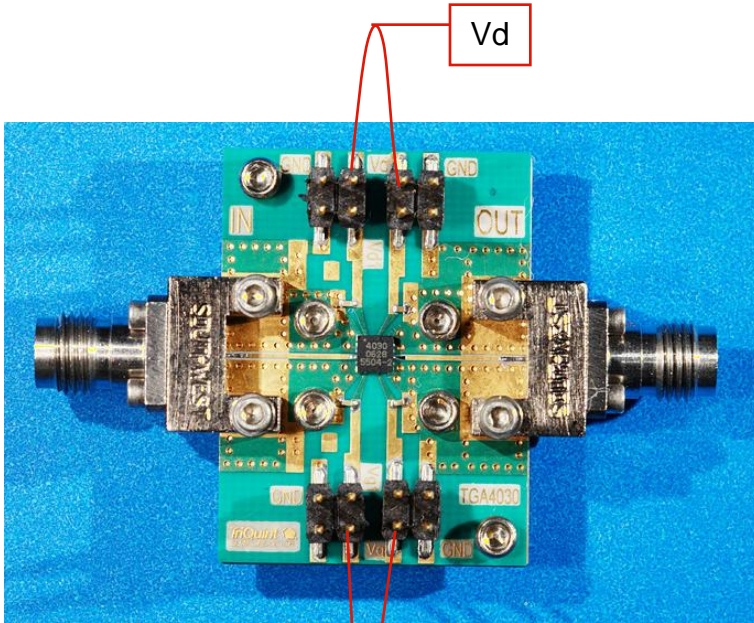

Bias Procedure

Powering up:

Set V_g (starting from 0V) to $-1.5V$

Increase V_d (starting from 0V) to desired voltage 5V

Make V_g more positive, ending up at approx $-0.75V$. $I_d \sim 140mA$.

Apply RF (max input level $+20dBm$).

Powering down:

Remove RF

Reduce V_d to 0V

Set V_g to $-1.5V$.

Amplifier

Set $V_d = 5.0V$

Vary $(V_g + V_{g1})$ to achieve $I_d = 140mA$

2x Multiplier

Set $V_d = 5.0V$

Set $V_{g1} = -1.1V$

Vary V_g to achieve $I_d = 120mA$

Recommended Power Supply Connection Diagram 3X Multiplier

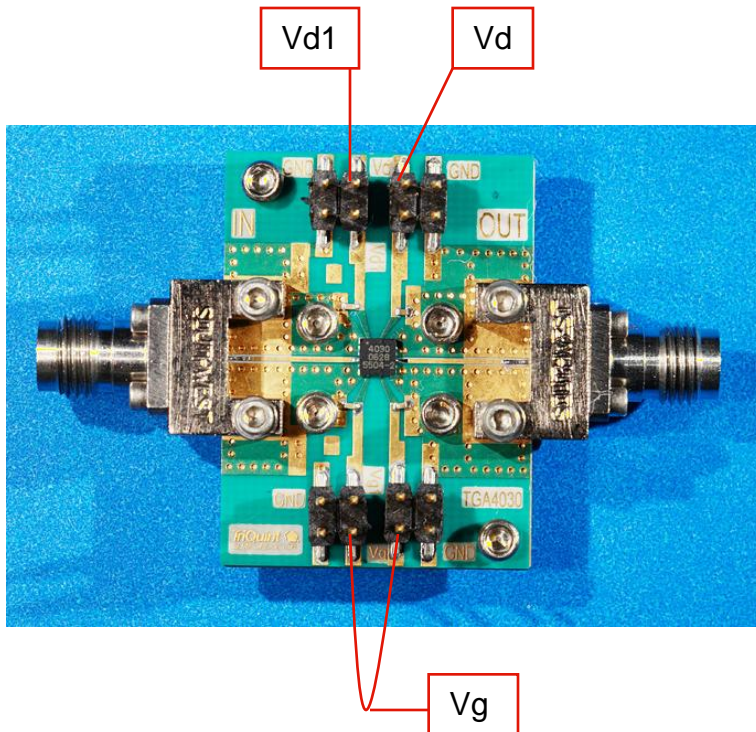

3x Multiplier

Set $V_d = 5.0V$

Set $V_{d1} = 1.0V$

Vary $(V_g + V_{g1})$ to achieve $(I_d + I_{d1}) = 160mA$

Recommended Surface Mount Package Assembly

Proper ESD precautions must be followed while handling packages.

Clean the board with acetone. Rinse with alcohol. Allow the circuit to fully dry.

TriQuint recommends using a conductive solder paste for attachment. Follow solder paste and reflow oven vendors' recommendations when developing a solder reflow profile. Typical solder reflow profiles are listed in the table below.

Hand soldering is not recommended. Solder paste can be applied using a stencil printer or dot placement. The volume of solder paste depends on PCB and component layout and should be well controlled to ensure consistent mechanical and electrical performance.

Clean the assembly with alcohol.

Typical Solder Reflow Profiles

Reflow Profile	SnPb	Pb Free
Ramp-up Rate	3 °C/sec	3 °C/sec
Activation Time and Temperature	60 – 120 sec @ 140 – 160 °C	60 – 180 sec @ 150 – 200 °C
Time above Melting Point	60 – 150 sec	60 – 150 sec
Max Peak Temperature	240 °C	260 °C
Time within 5 °C of Peak Temperature	10 – 20 sec	10 – 20 sec
Ramp-down Rate	4 – 6 °C/sec	4 – 6 °C/sec

Ordering Information

Part	Package Style
TGA4030-SM	3X3 QFN