

Single-Phase Full-Wave Motor Driver for Fan Motor

Features

- **Single Phase Full Wave Fan Driver**
- **Low Quiescent Current (6mA Typical)**
- **Built-in Variable Speed Function**
- **Minimum Speed Setting**
- **Built-In Current Limit Circuit (1.8A Typical)**
- **Built-In Lock Protection and Auto Restart Function**
- **Soft-Start Function**
- **RD (Lock Detection) Output**
- **Built-In Thermal Protection Circuit**
- **Lead Free and Green Devices Available (RoHS Compliant)**

General Description

The APX9212 is a single phase full wave DC brushless motor driver with PWM variable speed control, current limit, and soft-start features suitable for the fan of personal computer's power supply, CPU cooler and server. Adequate S-S pin capacitor could reduce the peak current at power on and lock mode. The PWM control system works depending on the comparison among the voltage of SET, MIN, and OSC. The device is equipped with a built-in lock protection, which protects the fan when it is locked. It also has rotation speed detection output and thermal protection function. The APX9212 is available in SSOP-16 and TSSOP-16P packages (see Pin Configuration).

Applications

- **CPU Cooler Fans**
- **Instrumentation Fans**
- **Variable Speed Control Fans**

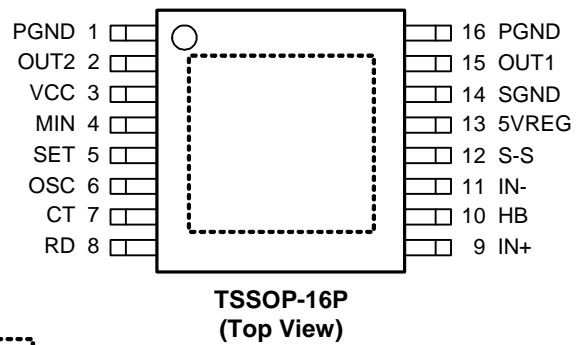
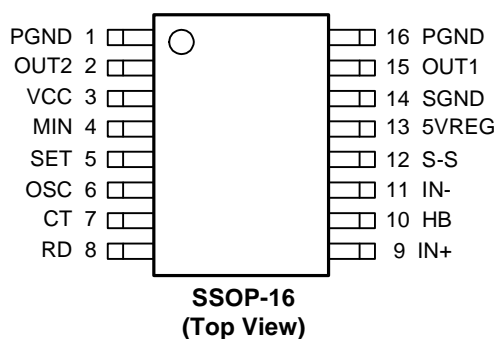

Pin Configuration



 =Thermal Pad (connected to the GND plane for better heat dissipation)

ANPEC reserves the right to make changes to improve reliability or manufacturability without notice, and advise customers to obtain the latest version of relevant information to verify before placing orders.

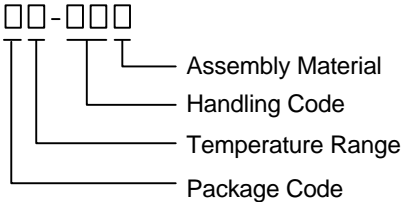
Ordering and Marking Information

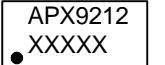
<p>APX9212 □□-□□□</p>  <p>Assembly Material Handling Code Temperature Range Package Code</p>	<p>Package Code N : SSOP-16 R : TSSOP-16P Temperature Range I : -40 to 110 °C Handling Code TR : Tape & Reel Assembly Material G : Halogen and Lead Free Device</p>
<p>APX9212 N:</p>	 <p>XXXXX - Date Code</p>
<p>APX9212 R:</p>	 <p>XXXXX - Date Code</p>

Note: ANPEC lead-free products contain molding compounds/die attach materials and 100% matte tin plate termination finish; which are fully compliant with RoHS. ANPEC lead-free products meet or exceed the lead-free requirements of IPC/JEDEC J-STD-020D for MSL classification at lead-free peak reflow temperature. ANPEC defines "Green" to mean lead-free (RoHS compliant) and halogen free (Br or Cl does not exceed 900ppm by weight in homogeneous material and total of Br and Cl does not exceed 1500ppm by weight).

Absolute Maximum Ratings (Note 1)

Symbol	Parameter	Ratings	Unit
V _{CC}	VCC Pin Supply Voltage (VCC to SGND)	-0.3 to 18	V
I _{OUT}	OUT1, OUT2 Pin Maximum Output Current	2	A
V _{OUT1, OUT2}	OUT1, OUT2 Pin Output Voltage	V _{PGND} -0.3 to V _{CC}	V
V _{PGND}	PGND to SGND Voltage	-0.3 to 0.3	V
V _{SET}	SET Pin Input Voltage (SET to SGND)	-0.3 to 7	V
V _{MIN}	MIN Pin Input Voltage (MIN to SGND)	-0.3 to 7	V
V _{S-S}	S-S Pin Withstand Voltage (S-S to SGND)	-0.3 to 7	V
	RD Pin Output Voltage	-0.3 to V _{CC}	V
I _{RD}	RD Pin Maximum Output Sink Current	10	mA
T _J	Maximum Junction Temperature	150	°C
T _{STG}	Storage Temperature	-65 to 150	°C
T _{SDR}	Maximum Lead Soldering Temperature, 10 Seconds	260	°C

Note1: Stresses beyond those listed under "absolute maximum ratings" may cause permanent damage to the device. These are stress ratings only and functional operation of the device at these or any other conditions beyond those indicated under "recommended operating conditions" is not implied. Exposure to absolute maximum rating conditions for extended periods may affect device reliability

Thermal Characteristics

Symbol	Parameter	Typical Value	Unit
$R_{TH, JA}$	Thermal Resistance-Junction to Ambient ^(Note 2)	SSOP-16	125
		TSSOP-16P	83
$R_{TH, JC}$	Thermal Resistance-Junction to Case ^(Note 2)	SSOP-16	26
		TSSOP-16P	19
P_D	Power Dissipation, $T_A=25^\circ\text{C}$	SSOP-16	1
		TSSOP-16P	1.5

Note 2: Mounted on a board (60x38x1.6t mm, Glass epoxy). The Thermal Pad on the bottom of TSSOP-16P package should be soldered directly to the PCB's Thermal Pad area that with several thermal vias connect to ground plan, and the PCB is a 2-layer, 10mm square area with 2oz copper thickness.

Recommended Operation Conditions (Note 3)

Symbol	Parameter	Range	Unit
V_{CC}	VCC Pin Supply Voltage Range	3.5 to 16	V
V_{SET}	SET Pin Input Voltage Range	0 to V_{SVREG}	V
V_{MIN}	MIN Pin Input Voltage Range	0 to V_{SVREG}	V
V_{ICM}	Hall Input (IN+, IN-) Common-Phase Input Voltage Range	0.2 to 3	V
T_A	Ambient Temperature	-40 to 110	$^\circ\text{C}$

Note 3: Refer to the typical application circuit

Electrical Characteristics ($V_{CC} = 12\text{V}$, $T_A = 25^\circ\text{C}$, unless otherwise specified)

Symbol	Parameter	Test Conditions	APX9212			Unit
			Min	Typ	Max	
SUPPLY CURRENT						
V_{SVREG}	5VREG Pin Output Voltage	$I_{SVREG} = 5\text{mA}$	4.8	5	5.2	V
V_{HB}	HB Pin Output Voltage	$I_{HB} = 5\text{mA}$	1.2	1.3	1.4	V
I_{CC1}	Operating Current	Rotation Mode	-	6	10	mA
I_{CC2}		Lock Protection Mode	-	6	10	
OSCILLATOR						
V_{OSCH}	OSC High Level Voltage		2.8	3	3.2	V
V_{OSCL}	OSC Low Level Voltage		0.85	1	1.15	V
I_{OSC1}	OSC Charge Current	$V_{OSC} = 0.5\text{V}$	24	30	36	μA
I_{OSC2}	OSC Discharge Current	$V_{OSC} = 3.5\text{V}$	24	30	36	μA
F_{OSC}	OSC Oscillation Frequency	$C_{OSC} = 220\text{pF}$	24	30	36	KHz

Electrical Characteristics (Cont.) ($V_{CC} = 12V$, $T_A = 25^\circ C$, unless otherwise specified)

Symbol	Parameter	Test Conditions	APX9212			Unit
			Min	Typ	Max	
LOCK PROTECTION						
V_{CTH}	CT Pin High Level Voltage		2.75	3	3.25	V
V_{CTL}	CT Pin Low Level Voltage		0.85	1	1.15	V
I_{CT1}	CT Charge Current	$V_{CT} = 0.5V$	1.5	2	2.5	μA
I_{CT2}	CT Discharge Current	$V_{CT} = 3.5V$	0.15	0.2	0.25	μA
R_{CT}	CT Charge/Discharge Current Ratio	$R_{CT} = I_{CT1}/I_{CT2}$	8	10	12	-
OUTPUT DRIVERS						
V_{OUT}	Output Driver Saturation Voltage	$I_{OUT} = 800mA$, Upper and Lower total	-	0.4	0.5	V
V_{RD}	RD Pin Low Voltage	$I_{RD} = 5mA$	-	0.1	0.2	V
I_{RDL}	RD Pin Leakage Current	$V_{RD} = 12V$	-	<0.1	1	μA
HALL SENSITIVITY						
V_{HN}	Hall Input Sensitivity	Zero to peak including offset and hysteresis	-	15	30	mV
CURRENT-LIMIT AND SOFT-START						
I_{LIM}	Output Current Limit		-	1800	-	mA
I_{S-S}	S-S Pin Charge Current	$V_{S-S} = 3V$	-	0.5	-	μA
THERMAL PROTECTION						
	Thermal Protection Temperature		-	165	-	$^\circ C$
	Thermal Protection Hysteresis		-	25	-	

Typical Operating Characteristics

VCC Supply Current vs. VCC Supply Voltage

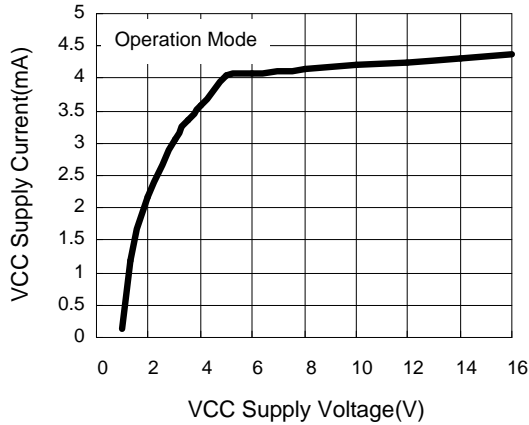

VCC Supply Current vs. VCC Supply Voltage

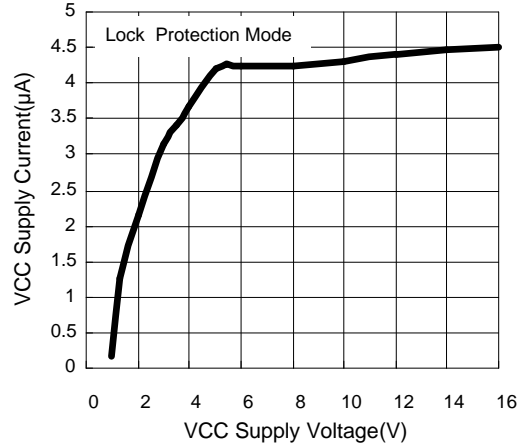

HB Voltage vs. VCC Supply Voltage

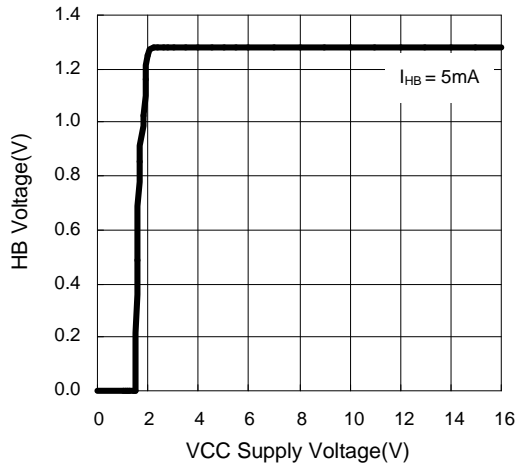

Output Saturation Voltage vs. Output Current

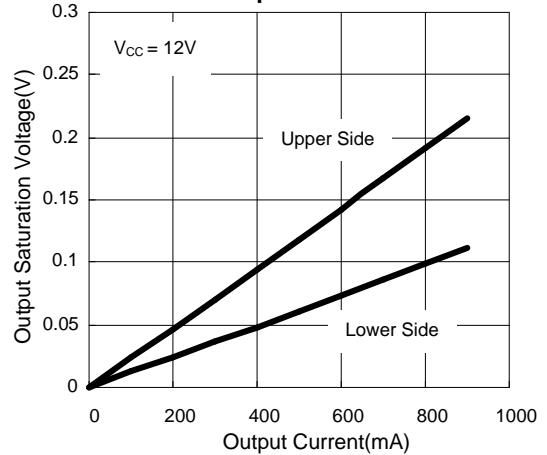

CT High/Low Voltage vs. VCC Supply Voltage

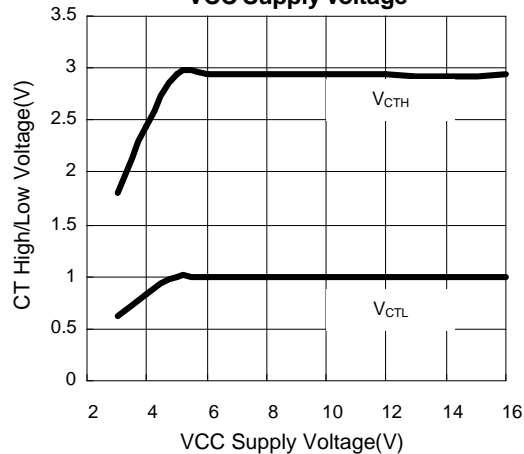

OSC High/Low Voltage vs. VCC Supply Voltage

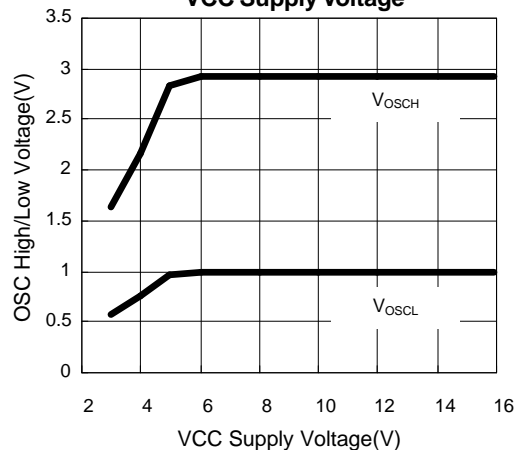

Typical Operating Characteristics (Cont.)

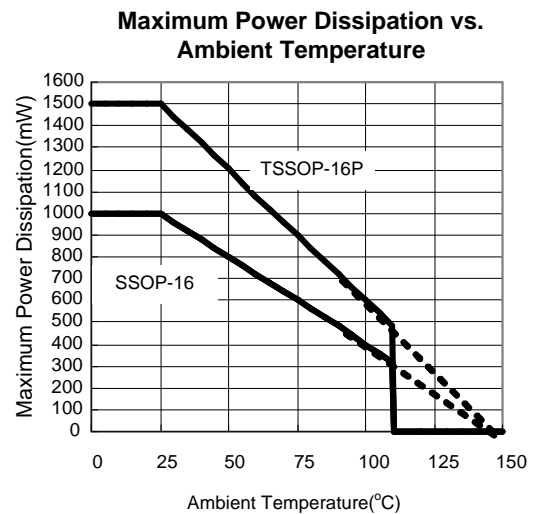
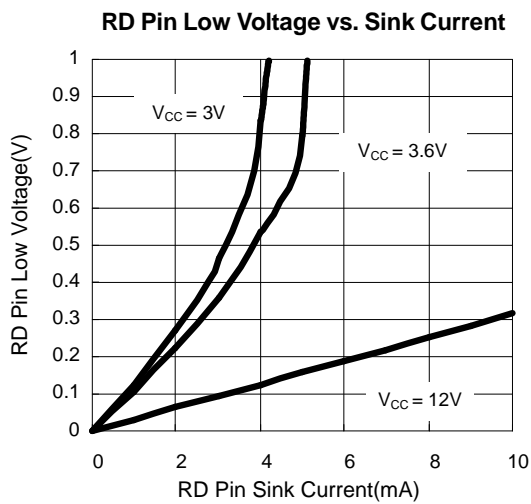
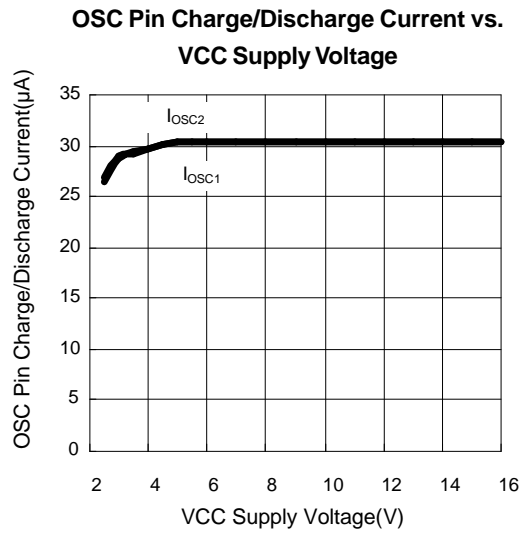
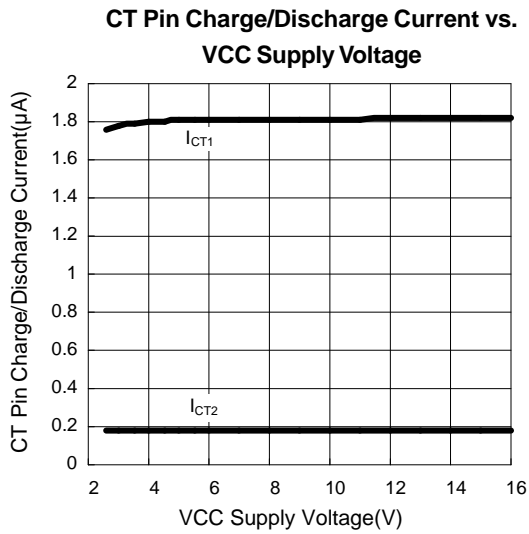

Pin Description

PIN		FUNCTION
NO.	NAME	
1,16	PGND	Power Stage GND. All of PGND pins must be connected to the ground of the power supply.
2	OUT2	H-bridge Output Connection. The output stage is a H-bridge formed by four transistors and four-protection diode for switching applications.
3	VCC	Supply Voltage Input Pin.
4	MIN	Minimum Speed Setting. Use a voltage divider from 5VREG to set MIN pin voltage for setting minimum speed of fan.
5	SET	Speed Setting. An external voltage into SET pin to set fan speed.
6	OSC	Oscillator Frequency Setting. Connect a capacitor to SGND to set oscillation frequency.
7	CT	Shutdown Time and Restart Time Setting. Connect a capacitor to SGND to set shutdown time and restart time in lock mode.
8	RD	Lock Detection Output. This is an open-drain output.
9	IN+	Hall Input +. Connect to hall element positive output.
10	HB	Hall Bias. This is a 1.3V constant-voltage output for hall element bias.
11	IN-	Hall Input -. Connect to hall element negative output.
12	S-S	Soft-Start Time Setting. Connect a capacitor to 5VREG to set soft-start time to reduce the large current at power on and lock mode.
13	5VREG	5V Regulator Output. This is a 5V constant-voltage output for application circuit biases.
14	SGND	Control Stage GND.
15	OUT1	H-bridge Output Connection. The output stage is a H-bridge formed by four transistors and four-protection diode for switching applications.

Block Diagram

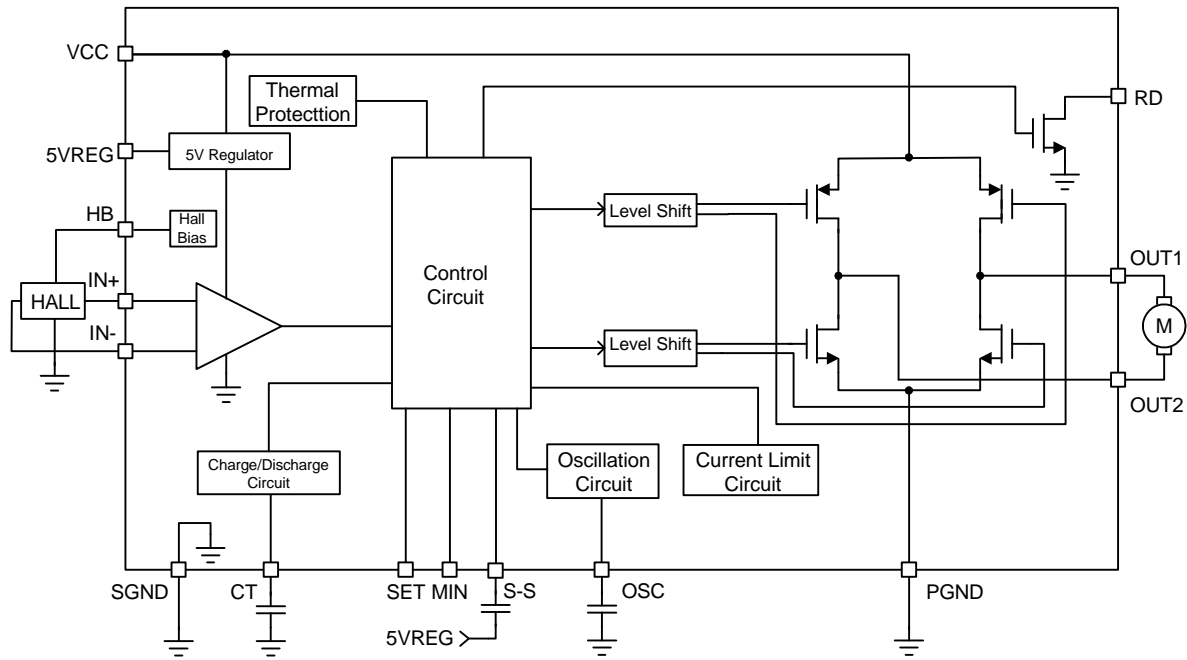

Typical Application Circuit

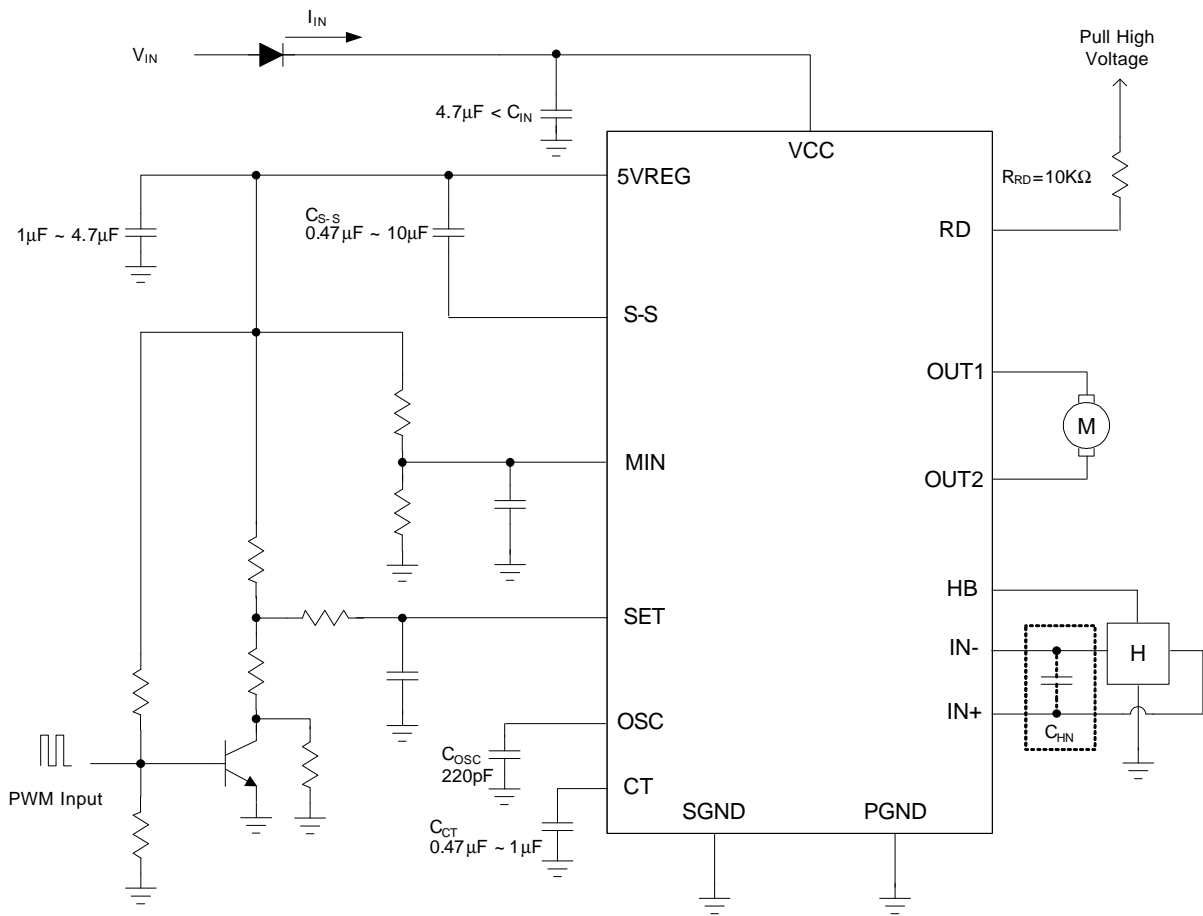

Note 4: All of PGND pins (Pin 1 and 16) must be connected to the ground of power supply.

Note 5: Insert the capacitor CHN to avoid noise coupling at power switch.

Function Description

Variable Speed Control

The APX9212 has a variable speed controller. The speed is controlled by comparing the voltage of OSC, MIN and SET. The lowest speed drive duty is set by comparing the OSC oscillating voltage and MIN pin voltage when MIN pin voltage is lower than SET. When SET pin voltage is lower than MIN, PWM control system works by comparing the voltage of SET and OSC. When SET pin voltage is lower than OSC, upper and lower side's transistors are ON. When SET pin voltage is higher than OSC, upper side transistors are OFF and coil current re-circulates lower side transistor. The lower SET pin voltage is, the more output ON duty will be. Hence, the coil current will be enlarged and motor speed will be faster. Rotation speed is able to feedback by FG output. PWM basic frequency will be 30 KHz when putting on $C_{OSC}=220pF$ (See Figure 1. Rotation Waveform).

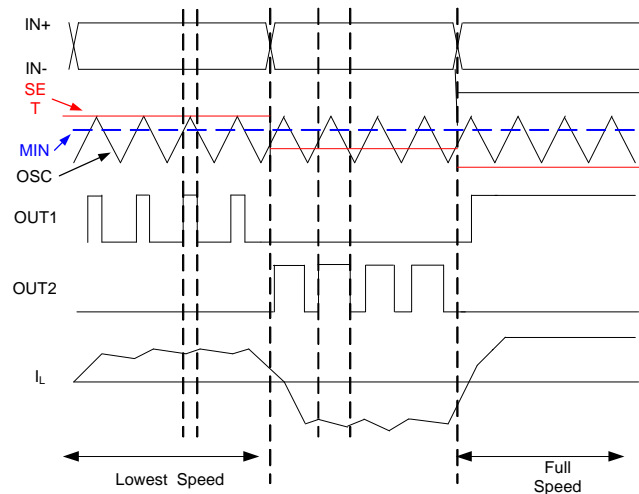

Figure 1. Rotation Waveform

Lockup Protection and Automatic Restart

The APX9212 provides the lockup protection and automatic restart functions to prevent the coil burnout while the fan is locked. Connecting the capacitor from CT pin to GND determines the shutdown time and restart time. As the fan is locked, the charge/discharge circuit will charge the CT capacitor to 3V by a $2\mu A$ source current for a locked detection time, and then the circuit will switch the capacitor to discharge.

During the discharging interval, the output drivers are switched off until the CT voltage is discharged to 1V by a $0.2\mu A$ sink current, and the circuit will switch the capacitor to charge. In the charging interval, the IC enters the restart time; one output is high and another is low, which makes a torque for fan rotation until the CT voltage is charged to 3V by a $2\mu A$ source current. If the locked condition still remains, the charge/discharge process will be recurrent until the locked condition is released (See Figure 2. Lock/Auto Restart Waveform)

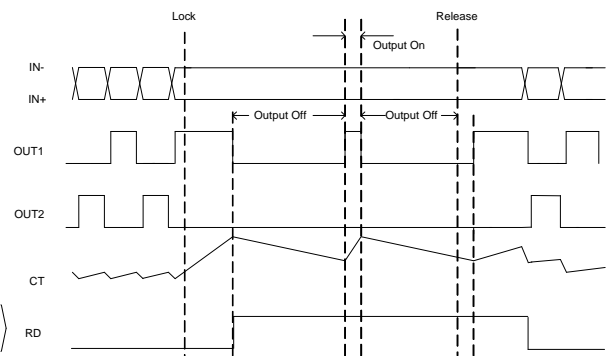

Figure 2. Lock/Auto Restart Waveform

Soft-Start Function

The APX9212 provides the soft-start function to avoid peak current at power-on and lock-restart moments. Connecting the capacitor from S-S pin to 5VREG can determine the soft start time. The soft-start function works depending on the comparison between the voltages of S-S, SET, MIN and OSC. An internal constant sink current charges an external capacitor C_{S-S} on the S-S pin from V_{OSCH} to 0V. When the S-S pin voltage is lower than OSC, S-S pin starts to control output driver ON duty. The lower S-S pin voltage is,

Function Description (Cont.)

Soft-Start Function (Cont.)

the more output driver ON duty will be. Hence, the coil current will be enlarged and the motor speed will be faster. S-S pin controls the output ON duty until its pin voltage is lower than SET (See Figure 3. Soft-Start Waveform at $V_{SET} < V_{MIN}$) or MIN (See Figure 4. Soft-Start Waveform at $V_{SET} > V_{MIN}$).

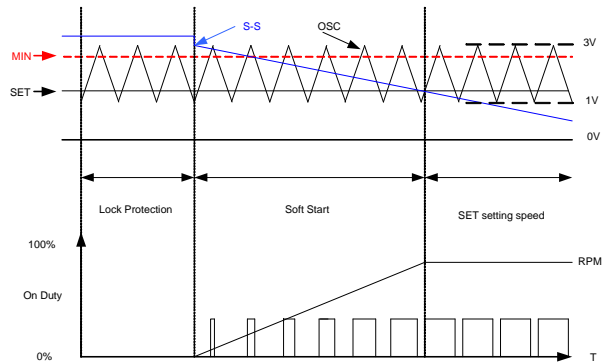

Figure 3. Soft Start Waveform at $V_{SET} < V_{MIN}$

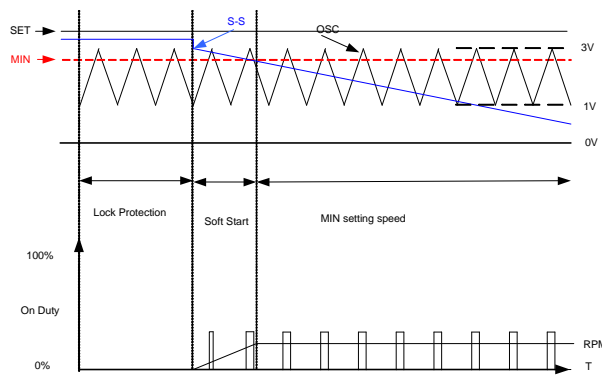

Figure 4. Soft Start Waveform at $V_{SET} > V_{MIN}$

Thermal Protection Function

The APX9212 is designed with a thermal protection to protect the IC from the damage of over temperature. When internal junction temperature reaches 165°C, the output devices will be switched off. When the IC's junction temperature cools by 25°C, the thermal sensor will turn the output devices on again resulting in a pulsed output during continuous thermal overload.

Truth Table

Input				Output			Mode
IN-	IN+	OSC	CT	OUT1	OUT2	RD	
H	L	H	L	H	L	L	Rotation (Drive)
L	H			L	H	L	PWM ON
H	L	L		OFF	L	L	Rotation (Regeneration)
L	H			L	OFF	L	PWM OFF
H	L	-	H	L	L	OFF	Lock Mode
L	H			L	L	OFF	

OSC-H corresponds to $V_{OSC} > V_{SET}$ and OSC-L corresponds to $V_{OSC} < V_{SET}$

Application Information

HB Pin & Hall Input

1.3V voltage reference is for hall element bias. Being short lines is for noise immunity. Hall input amplifier has 20mV hysteresis. Therefore, we recommend the hall input level to be 100mV or above.

CT Capacitor

The capacitor that is connected from CT pin to GND determines the shutdown time and restart time.

$$\text{Locked Detection Time} = \frac{C_{CT} \times (V_{CTH} - 0.2V)}{I_{CT1}}$$

$$\text{Restart Time} = \frac{C_{CT} \times (V_{CTH} - V_{CTL})}{I_{CT1}}$$

$$\text{Shutdown Time} = \frac{C_{CT} \times (V_{CTH} - V_{CTL})}{I_{CT2}}$$

where

C_{CT} = CT pin capacitor

For example:

$V_{CC}=12V, C_{CT}=1\mu F$

Locked Detection Time = 1.7s

Restart Time = 1s

Shutdown Time = 10s

The value of charge capacitor is recommended 0.47 μF to 1 μF .

S-S Capacitor

The capacitor that is connected from S-S pin to 5VREG determines the soft start time.

Case 1 : $V_{OSCL} < V_{SET} < V_{MIN}$

$$\text{Soft Start Time} = \frac{C_{S-S} \times (V_{OSCH} - V_{SET})}{I_{S-S}}$$

where:

C_{S-S} = S-S pin capacitor

For example:

$V_{CC}=12V, V_{OSCH}=3V, V_{OSCL}=1V, V_{SET}=1.4V, I_{S-S}=0.5\mu A,$

$C_{S-S}=1\mu F$

Soft Start Time = 3.2s

Case 2 : $V_{SET} < V_{OSCL} < V_{MIN}$

$$\text{Soft Start Time} = \frac{C_{S-S} \times (V_{OSCH} - V_{OSCL})}{I_{S-S}}$$

For example:

$V_{CC}=12V, V_{OSCH}=3V, V_{OSCL}=1V, V_{SET}=0.5V, I_{S-S}=0.5\mu A,$
 $C_{S-S}=1\mu F$

Soft Start Time = 4s

The value of S-S pin capacitor is recommended 0.47 μF to 10 μF . The choices of CT pin and S-S pin capacitors should be considered that fan must start up during restart time at lock mode. When the C_{CT} is determined and the fan can't start up at power-on or lock-restart mode, decrease the C_{S-S} capacitance can let the fan start up successfully but it will reduce the soft start time.

RD Resistor

The value of the RD resistor could be decided by the following equation:

$$R_{RD} = \frac{V_{CC} - V_{RD}}{I_{RD}}$$

The value of resistor in the range of 10K is recommended.

Package Information

SSOP-16

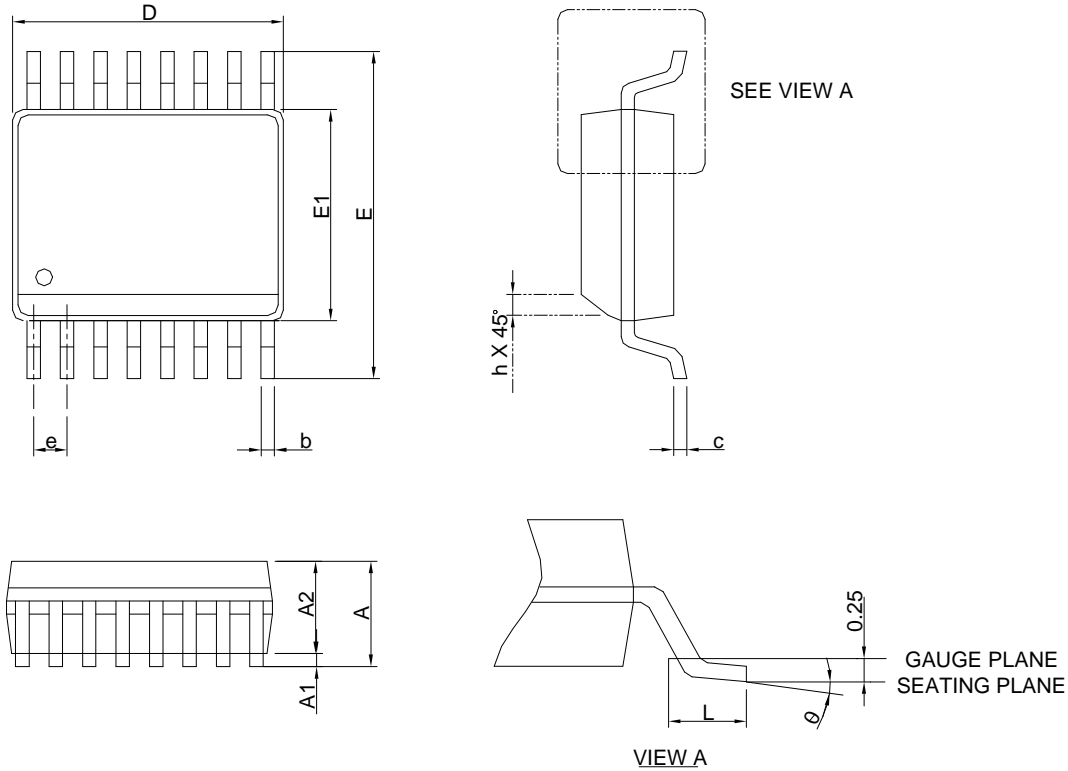

DIMENSIONS	SSOP-16			
	MILLIMETERS		INCHES	
	MIN.	MAX.	MIN.	MAX.
A		1.75		0.069
A1	0.10	0.25	0.004	0.010
A2	1.24		0.049	
b	0.20	0.30	0.008	0.012
c	0.15	0.25	0.006	0.010
D	4.80	5.00	0.189	0.197
E	5.80	6.20	0.228	0.244
E1	3.80	4.00	0.150	0.157
e	0.635 BSC		0.025 BSC	
L	0.40	1.27	0.016	0.050
h	0.25	0.50	0.010	0.020
θ	0°	8°	0°	8°

- Note : 1. Follow JEDEC MO-137 AB.
 2. Dimension "D" does not include mold flash, protrusions or gate burrs. Mold flash, protrusion or gate burrs shall not exceed 6 mil per side.
 3. Dimension "E" does not include inter-lead flash or protrusions. Inter-lead flash and protrusions shall not exceed 10 mil per side.

Package Information

TSSOP-16P

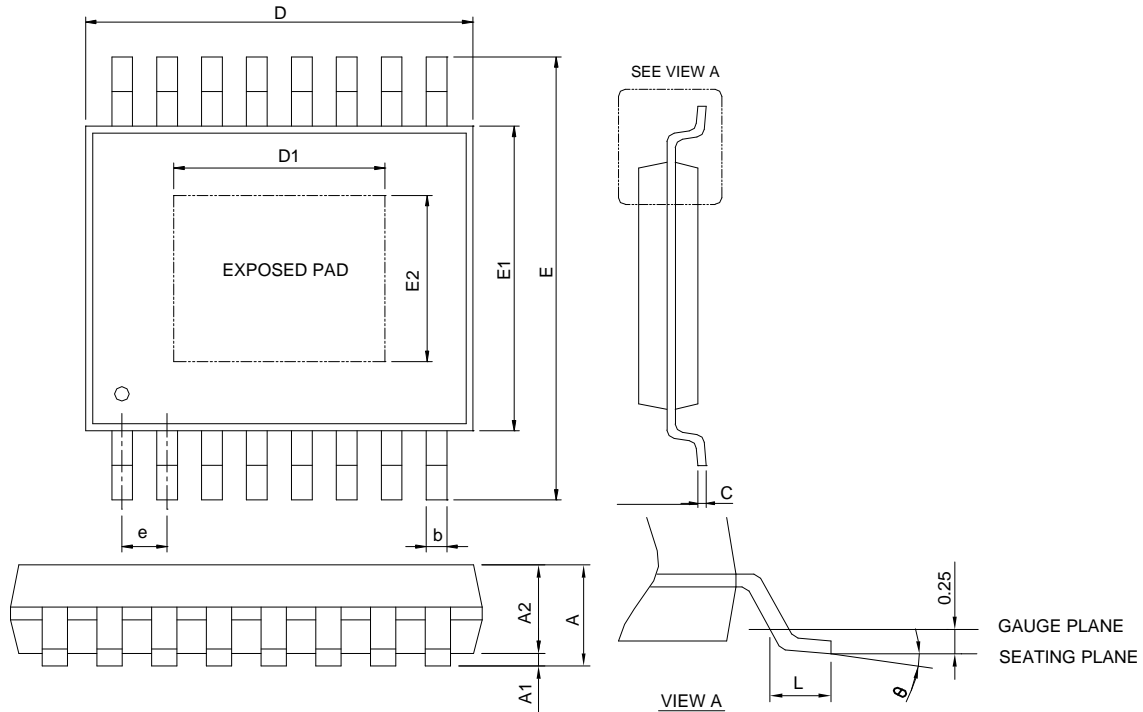

SYMBOL	TSSOP-16P			
	MILLIMETERS		INCHES	
	MIN.	MAX.	MIN.	MAX.
A		1.20		0.047
A1	0.05	0.15	0.002	0.006
A2	0.80	1.05	0.031	0.041
b	0.19	0.30	0.007	0.012
c	0.09	0.20	0.004	0.008
D	4.90	5.10	0.193	0.201
D1	2.00	3.50	0.079	0.138
E	6.20	6.60	0.244	0.260
E1	4.30	4.50	0.169	0.177
E2	2.50	3.50	0.098	0.138
e	0.65 BSC		0.026 BSC	
L	0.45	0.75	0.018	0.030
θ	0°	8°	0°	8°

Note : 1. Follow from JEDEC MO-153 AB.

2. Dimension "D" does not include mold flash, protrusions or gate burrs. Mold flash, protrusion or gate burrs shall not exceed 6 mil per side.

3. Dimension "E1" does not include inter-lead flash or protrusions. Inter-lead flash and protrusions shall not exceed 10 mil per side.

Carrier Tape & Reel Dimensions

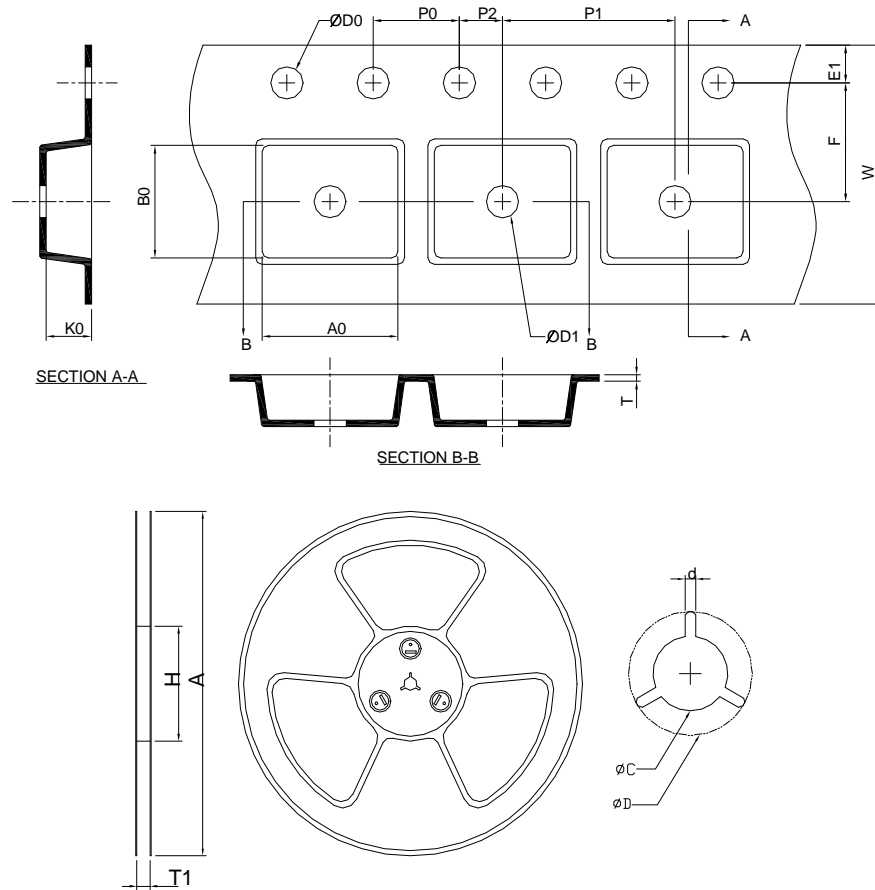

Application	A	H	T1	C	d	D	W	E1	F
SSOP-16	330.0 ±2.00	50 MIN.	12.4+2.00 -0.00	13.0+0.50 -0.20	1.5 MIN.	20.2 MIN.	12.0 ±0.30	1.75 ±0.10	5.50 ±0.10
	P0	P1	P2	D0	D1	T	A0	B0	K0
	4.00 ±0.10	8.00 ±0.10	2.00 ±0.05	1.5+0.10 -0.00	1.5 MIN.	0.6+0.00 -0.40	6.40 ±0.20	5.20 ±0.20	2.10 ±0.20
Application	A	H	T1	C	d	D	W	E1	F
TSSOP-16P	330.0 ±2.00	50 MIN.	12.4+2.00 -0.00	13.0+0.50 -0.20	1.5 MIN.	20.2 MIN.	12.0 ±0.30	1.75 ±0.10	5.50 ±0.05
	P0	P1	P2	D0	D1	T	A0	B0	K0
	4.00 ±0.10	8.00 ±0.10	2.00 ±0.05	1.5+0.10 -0.00	1.5 MIN.	0.6+0.00 -0.40	6.90 ±0.20	5.40 ±0.20	1.60 ±0.20

(mm)

Devices Per Unit

Package Type	Unit	Quantity
SSOP-16	Tape & Reel	2500
TSSOP-16P	Tape & Reel	2500

Taping Direction Information

SSOP-16

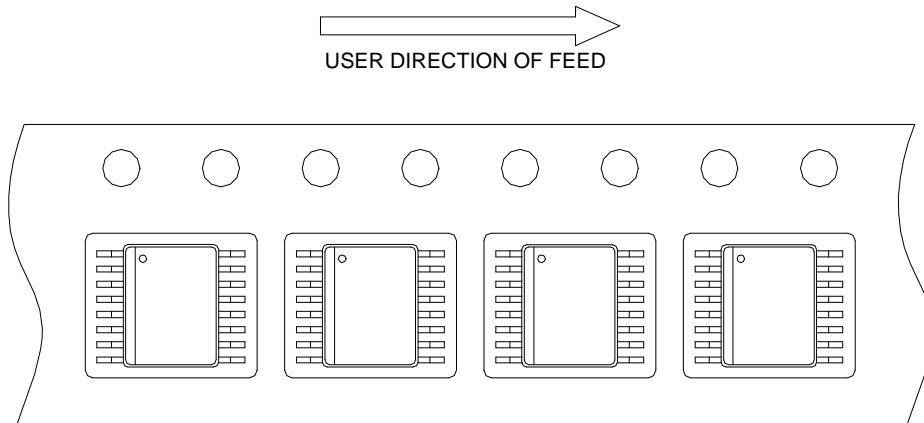

TSSOP-16P

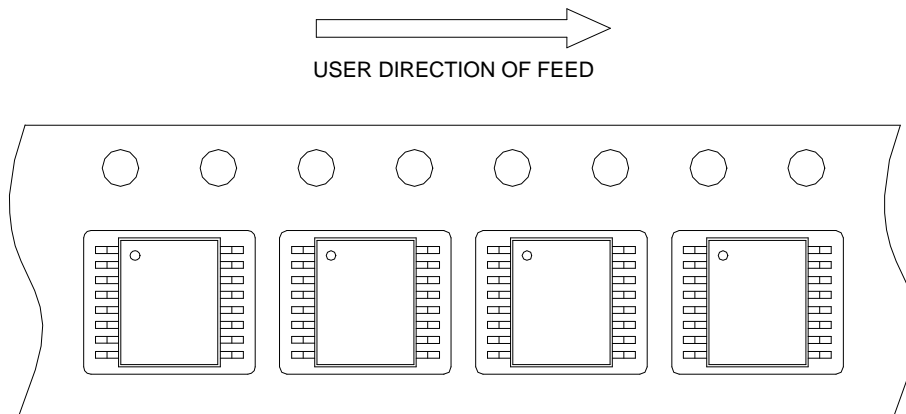

Classification Profile

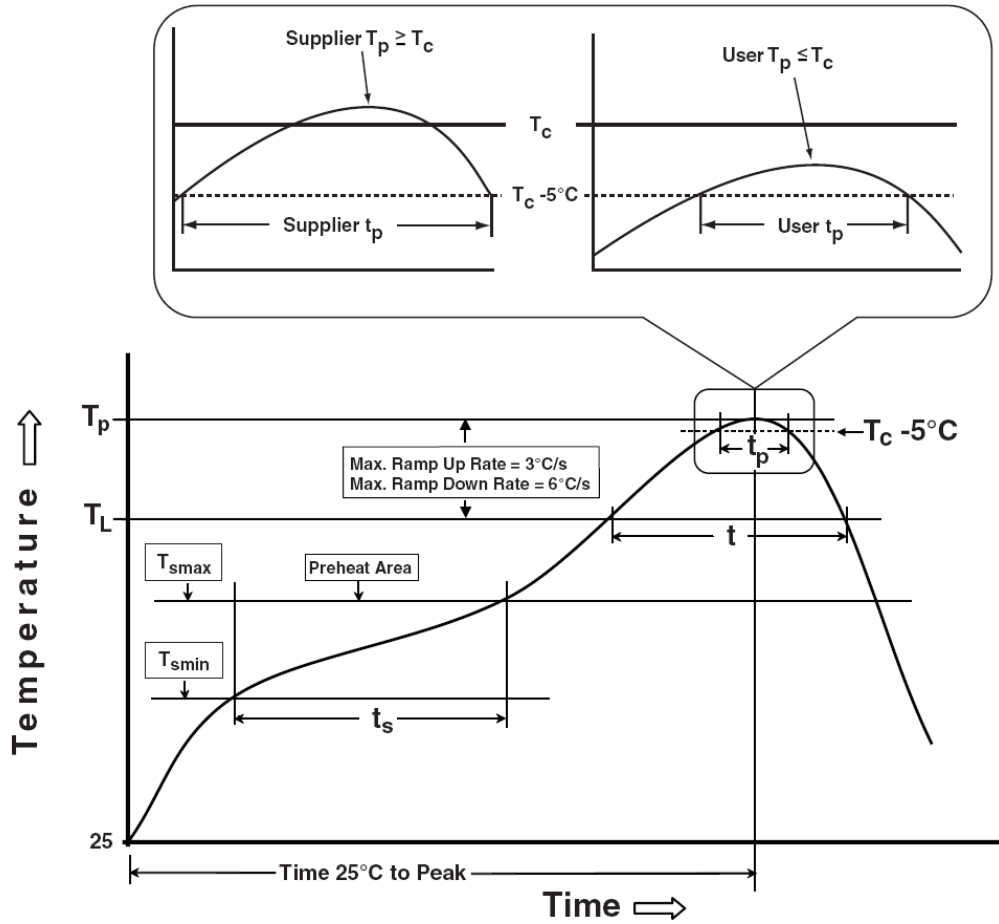

Classification Reflow Profiles

Profile Feature	Sn-Pb Eutectic Assembly	Pb-Free Assembly
Preheat & Soak		
Temperature min (T_{smin})	100 °C	150 °C
Temperature max (T_{smax})	150 °C	200 °C
Time (T_{smin} to T_{smax}) (t_s)	60-120 seconds	60-120 seconds
Average ramp-up rate (T_{smax} to T_p)	3 °C/second max.	3°C/second max.
Liquidous temperature (T_L)	183 °C	217 °C
Time at liquidous (t_L)	60-150 seconds	60-150 seconds
Peak package body Temperature (T_p)*	See Classification Temp in table 1	See Classification Temp in table 2
Time (t_p)** within 5°C of the specified classification temperature (T_c)	20** seconds	30** seconds
Average ramp-down rate (T_p to T_{smax})	6 °C/second max.	6 °C/second max.
Time 25°C to peak temperature	6 minutes max.	8 minutes max.
* Tolerance for peak profile Temperature (T_p) is defined as a supplier minimum and a user maximum.		
** Tolerance for time at peak profile temperature (t_p) is defined as a supplier minimum and a user maximum.		

Table 1. SnPb Eutectic Process – Classification Temperatures (T_c)

Package Thickness	Volume mm ³ <350	Volume mm ³ ≥350
<2.5 mm	235 °C	220 °C
≥2.5 mm	220 °C	220 °C

Table 2. Pb-free Process – Classification Temperatures (T_c)

Package Thickness	Volume mm ³ <350	Volume mm ³ 350-2000	Volume mm ³ >2000
<1.6 mm	260 °C	260 °C	260 °C
1.6 mm – 2.5 mm	260 °C	250 °C	245 °C
≥2.5 mm	250 °C	245 °C	245 °C

Reliability Test Program

Test item	Method	Description
SOLDERABILITY	JESD-22, B102	5 Sec, 245°C
HOLT	JESD-22, A108	1000 Hrs, Bias @ $T_j=125^\circ\text{C}$
PCT	JESD-22, A102	168 Hrs, 100%RH, 2atm, 121°C
TCT	JESD-22, A104	500 Cycles, -65°C~150°C
HBM	MIL-STD-883-3015.7	VHBM 2KV
MM	JESD-22, A115	VMM 200V
Latch-Up	JESD 78	10ms, 1 _{tr} 100mA

Customer Service

Anpec Electronics Corp.

Head Office :

No.6, Dusing 1st Road, SBIP,
Hsin-Chu, Taiwan
Tel : 886-3-5642000
Fax : 886-3-5642050

Taipei Branch :

2F, No. 11, Lane 218, Sec 2 Jhongsing Rd.,
Sindian City, Taipei County 23146, Taiwan
Tel : 886-2-2910-3838
Fax : 886-2-2917-3838