

| | | |
|------|-------------|-----------|
| REV. | DESCRIPTION | DATE |
| A | NEW DRAWING | 12/1/2008 |

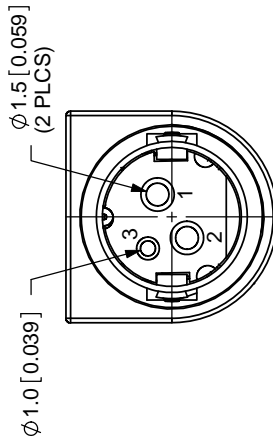
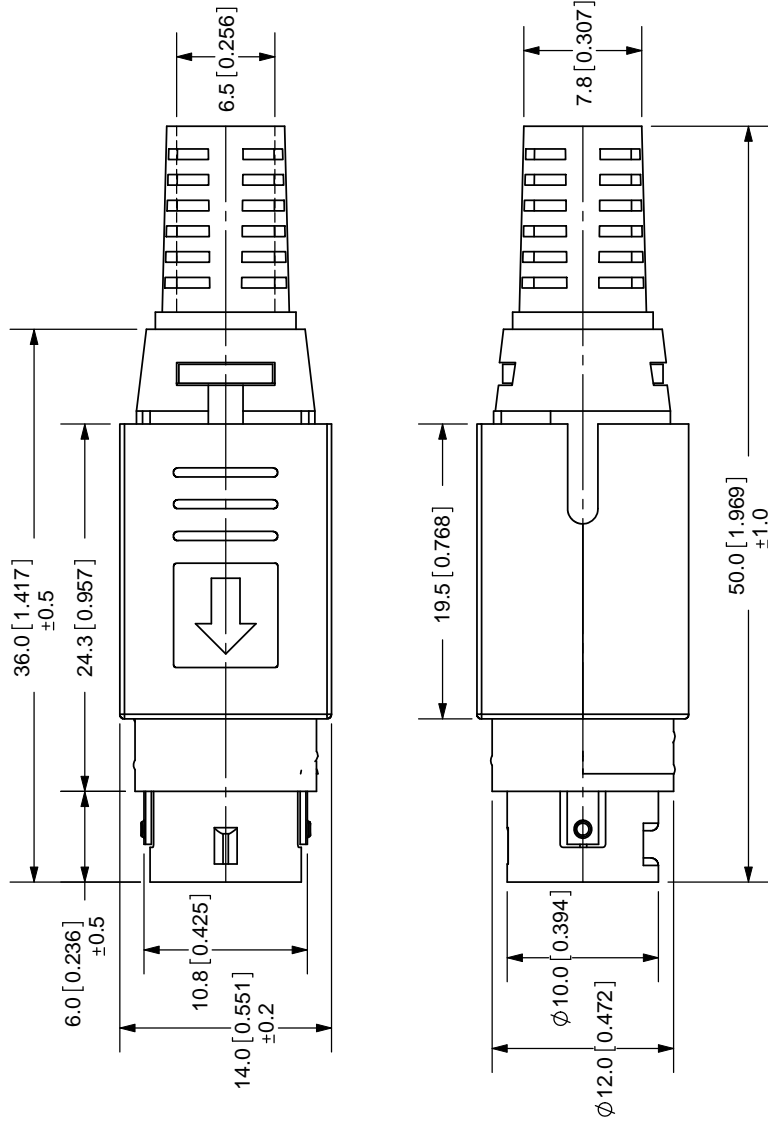

TOLERANCE:
±0.2mm UNLESS OTHERWISE
SPECIFIED

SPECIFICATIONS:
RATING: PINS 1&2: 20V DC @ 7.5A
PIN 3: 20V DC @ 1A
INSULATION RESISTANCE: 50M OHMS MIN: 250V DC
VOLTAGE WITHSTAND: 250V AC R.M.S. FOR 1 MINUTE
LIFE: 5,000 CYCLES

| | MATERIAL | PLATING |
|---------------|-----------|---------|
| OUTER HOOD | ABS | |
| METAL SLEEVE | Brass | Nickel |
| CLAMP | Brass | Nickel |
| PIN/BODY | Brass/PBT | Silver |
| PLASTIC RING | POM | |
| METAL COVER | Brass | Nickel |
| SPRING | Steel | |
| INNER HOOD | ABS | |
| STRAIN RELIEF | PVC | |

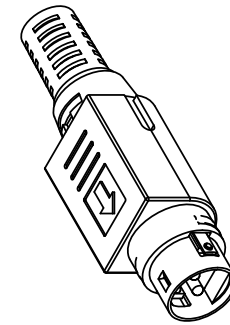

SCALE: 1:2







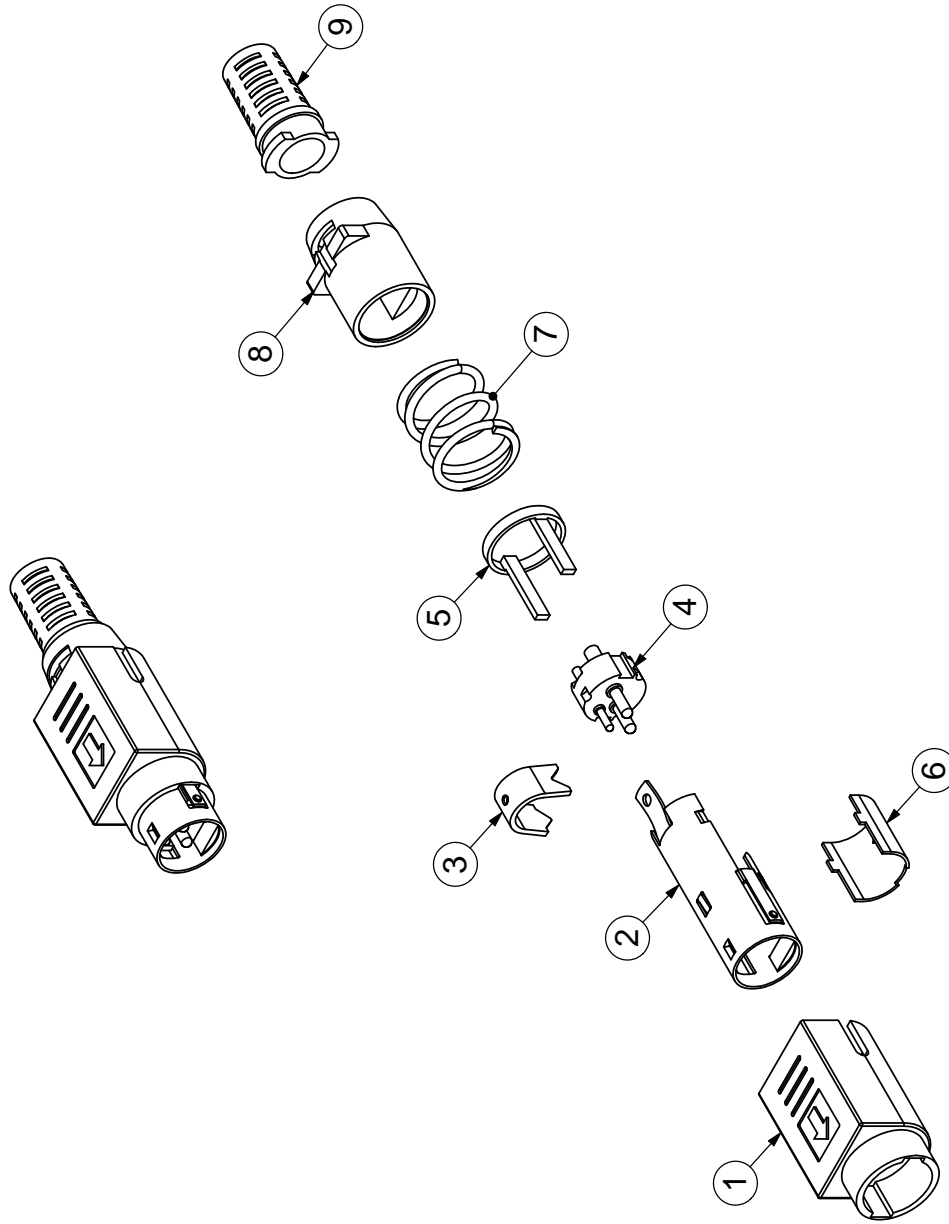

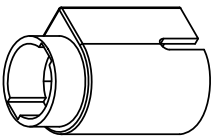

20050 SW 112th Ave.
Tualatin, OR 97062
Phone: 503-612-2300
800-275-4899
Fax: 503-612-2383
Website: www.cui.com

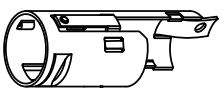
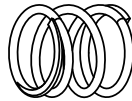
| | |
|-----------------------------|--------------------|
| TITLE: 3-PIN POWER DIN PLUG | REV: A |
| PART NO: PDP-30 | UNITS: MM [INCHES] |
| DRAWN BY: ZRJ | APPROVED BY: |
| | SCALE: 2:1 |

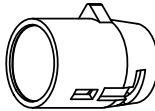

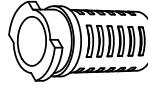
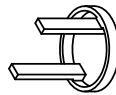
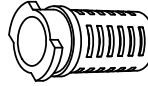
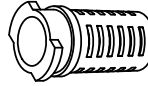
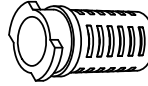
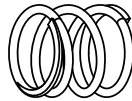
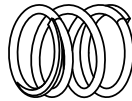
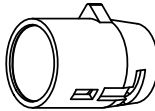
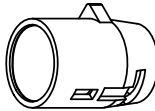
| | |
|-----------------------------|--------------------|
| TITLE: 3-PIN POWER DIN PLUG | REV: A |
| PART NO: PDP-30 | UNITS: MM [INCHES] |
| DRAWN BY: ZRJ | APPROVED BY: |
| | SCALE: 1:1 |

| | | | |
|---|---------------|---|--|
| 1 | outer hood |  |  |
| 2 | metal sleeve |  |  |
| 3 | clamp |  |  |
| 4 | pin body |  |  |
| 5 | plastic ring |  |  |
| 6 | strain relief |  |  |
| 7 | spring |  |  |
| 8 | inner hood |  |  |
| 9 | metal cover |  |  |

STEP 1

insert strain relief (9), inner hood (8), and spring (7) onto cable

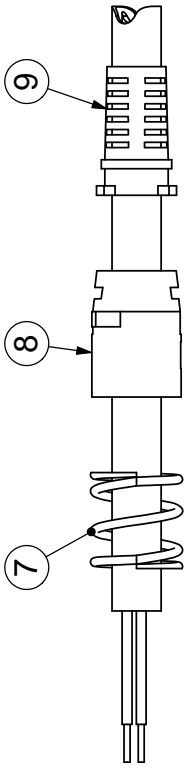

STEP 2

solder wires to contacts on pin body (4)

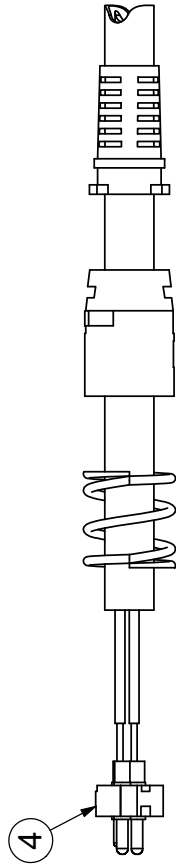

STEP 3

push pin body (4) and plastic ring (5) into metal sleeve (2)

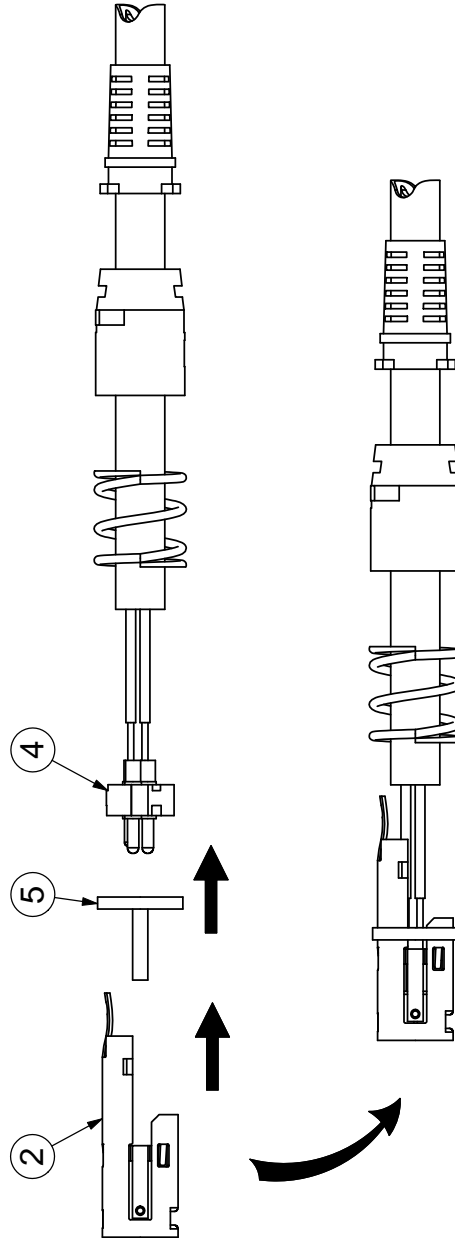

| | |
|-----------------------------|--------------------|
| TITLE: 3-PIN POWER DIN PLUG | REV: A |
| PART NO: PDP-30 | UNITS: MM [INCHES] |
| DRAWN BY: ZRJ | APPROVED BY: |
| | SCALE: 1:1 |

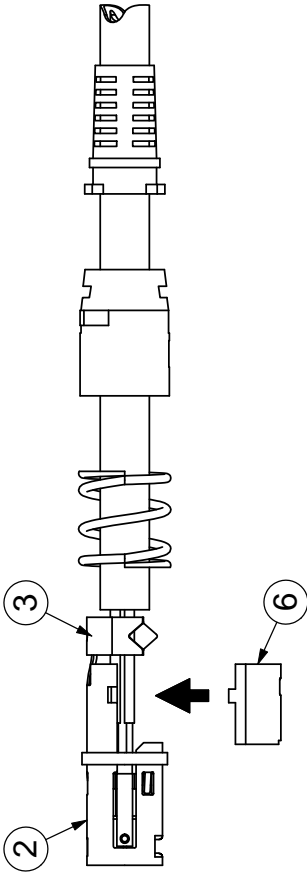

STEP 4
crimp the clamp (3)
onto wires, assemble
metal cover (6) onto
metal sleeve (2)

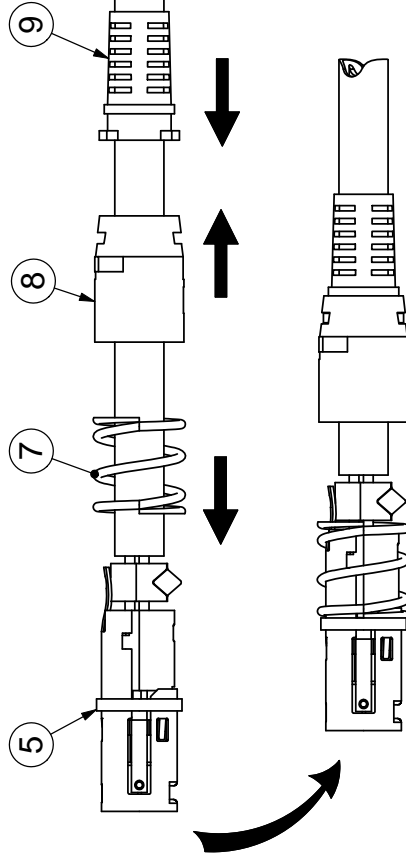

STEP 5
push spring (7) up
to plastic ring (5),
assemble inner hood (8)
and strain relief (9)
together

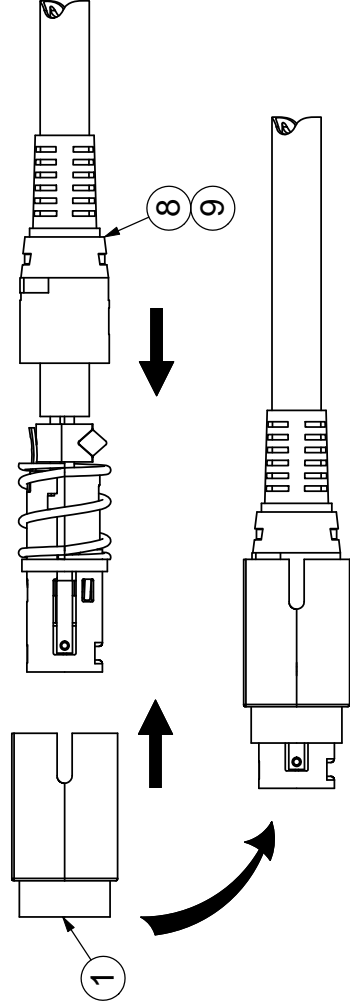

STEP 6
push outer hood (1)
and inner hood/
strain relief (8,9)
together

| | |
|-----------------------------|--------------------|
| TITLE: 3-PIN POWER DIN PLUG | REV: A |
| PART NO: PDP-30 | UNITS: MM [INCHES] |
| DRAWN BY: ZRJ | APPROVED BY: |
| | SCALE: 1:1 |