

# SFP Optical Transceivers for 2.7Gb/s 180km DWDM Applications

## IGP-28111J

The Bookham IGP-28111J optical transceiver is a high performance, cost effective module for serial optical data communication applications up to 4.25Gb/s. The IGP-28111J is designed to accept DWDM SONET/SDH (with or without FEC) and Ethernet protocol traffic for 180km links.

The product is designed for single mode fibre and operate at ITU wavelengths across the C- and L-band.

The modules aid system hardware engineers in implementing low-cost DWDM solutions, which are protocol transparent. The “hot pluggable” feature built into every module reduces manufacturing and inventory costs allowing optical port upgrades at the customer premises. Built-in remote monitoring via digital diagnostics allows user access to static and dynamic data as well as module condition.

The IGP-28111J uses the established Bookham Buried Heterostructure Directly Modulated Laser (BH DML) packaged in a compact cooled TOSA. The transmitter has full IEC60825-1:2001 and CDRH Class I laser safety certification.

The Bookham IGP-28111J module has been extensively tested utilizing industry standard single mode fibres in order to ensure compatibility with SONET-grade enterprise, access and metro systems. Additionally, all Bookham products are UL, CAN/CSA, FCC, IEC, and CDRH compliant.

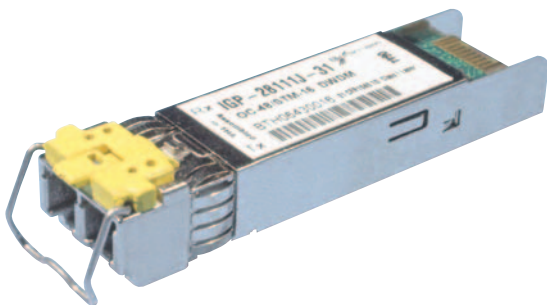

### Features:

- 180km (3600ps/nm) transmission compliant to V-16.2
- DWDM SFP MSA compatible
- +4dBm optical power output
- 100GHz channel spacing
- C- and L-Band coverage
- Up to 4.25Gb/s data rate
- High accuracy thermal wavelength management
- Extended APD-based receiver sensitivity
- Typically 880mW power consumption
- Single +3.3V power supply
- 0°C to +70°C operating case temperature range
- Hot Pluggable
- Duplex LC connector
- Enhanced digital diagnostics
- Low EMI

### Compliance:

- CDRH & IEC Laser Safety
- FCC Class B EMI
- MIL-STD-883 ESD
- IEC/EN60950 Product Safety
- RoHS compliant 

### Applications:

- OC-48/STM-16/OTN-1 DWDM Metro/Access Networks
- Ethernet IEEE 802.3ae
- Fibre channel
- Network Edge devices, μMSPP
- Subscriber Loop label

## Absolute Maximum Ratings

Parameter	Symbol	Min	Max	Unit
Storage Temperature	$T_{STG}$	-40	85	°C
Supply Voltage	$V_{CC}$	-0.3	4.0	V
Data AC Voltage	Tx+, Tx-		2.4	$V_{PP}$
Data DC Voltage	Tx+, Tx-	-0.5	3.47	V
Optical Input Received Power	$P_{IN}$		+5	dBm

## Operating Conditions

Parameter	Symbol	Min	Typical	Max	Unit
Case temperature	$T_{CASE}$	0		70	°C
Supply Voltage	$V_{CC}$	3.13	3.30	3.47	V
Supply Current[1]	$I_{CC}$		265	418	mA
Module Power Dissipation	P		0.88	1.45	W
In-rush Current[2]	$I_{IN-RUSH}$			100	mA

**Notes:**

[1] Supply current is shared between  $V_{CCTX}$  and  $V_{CCR_X}$ .

[2] In-rush is defined as current level above steady state current requirements.

## Transmitter Operating Specifications – Optical

All specifications relate to End of Life (EOL) values over temperature and supply voltage, unless otherwise stated.

Parameter	Symbol	Value			Units	Notes
		Min	Typical	Max		
Data Rate	BR	0.125	2.667	4.25	Gb/s	
ITU-T Center Wavelength	$\lambda_C$	1530		1606	nm	Refer to Table 6 & Table 7 for details
Center Wavelength (SOL)	$\lambda_{SOL}$	$\lambda_C - 0.05$	$\lambda_C - 0.02$	$\lambda_C$	nm	Where $\lambda_C$ is a defined ITU-T wavelength
Wavelength Stability	$\Delta\lambda_C$	$\lambda_C - 0.1$	$\lambda_C$	$\lambda_C + 0.1$	nm	
Optical Transmit Power	$P_O$	+2		+4	dBm	Modulated at 2.488Gb/s
Optical Transmit Power (disabled)	$P_{TX\_DISABLE}$			-40	dBm	
Spectral Width	$\Delta\lambda_{20}$		0.1	0.3	nm	20dB down from peak using 10pm RBW
SMSR		40			dB	
Extinction Ratio	ER	8.2			dB	Filtered eye
Dispersion Tolerance	DT	-1200		3600	ps/nm	Modulated at 2.667Gb/s
		-1200		1600	ps/nm	Modulated at 4.25Gb/s
		-1200		10000	ps/nm	Modulated at 1.25Gb/s
Dispersion Penalty	DP			2	dB	
Jitter Generation (SOL)	$T_{J\_RMS}$			10	mUI	RMS
Jitter Generation (SOL)	$T_{J\_P-P}$			70	mUI	Peak-to-Peak
Output Optical Eye	Compliant with Bellcore GR-253-CORE & ITU G.957 for SONET/SDH and with IEEE 802.3ae for Ethernet and Fibre Channel					

## APD Receiver Operating Specifications – Optical

All specifications relate to End of Life (EOL) values over temperature and supply voltage, unless otherwise stated.

Parameter	Symbol	Value			Units	Notes
		Min	Typical	Max		
Receiver Sensitivity (OSNR = 30dB)	Rx <sub>SENS_1</sub>			-28	dBm	Note 1, 8
				-24	dBm	Note 2, 8
				-34	dBm	Note 3, 8
Receiver Sensitivity (OSNR = 21dB)	Rx <sub>SENS_2</sub>			-24	dBm	Note 4, 8
Receiver Sensitivity (OSNR = 25dB)	Rx <sub>SENS_3</sub>			-22	dBm	Note 5, 8
Maximum Input Power	Rx <sub>OVERLOAD</sub>	-7			dBm	Note 1
		-9			dBm	Note 5
		-16			dBm	Note 6
Input Operating Wavelength	$\lambda_{RX}$	1260		1610	nm	Note 7
Reflectance	R <sub>RX</sub>			-27	dB	
Loss of Signal - Asserted	P <sub>A</sub>	-40		-33	dBm	
Loss of Signal - Deasserted	P <sub>D</sub>			-31	dBm	
Hysteresis	P <sub>A</sub> - P <sub>D</sub>	0.5		4	dB	

### Notes:

- [1] Average power at  $1 \times 10^{-12}$  BER and data rates of 125Mb/s to 2.667Gb/s.
- [2] Average power at  $1 \times 10^{-12}$  BER and a data rate of 4.25Gb/s.
- [3] Average power at  $1 \times 10^{-4}$  BER and a data rate of 2.667Gb/s.
- [4] Average power at  $1 \times 10^{-12}$  BER and a data rate of 2.667Gb/s over 180km fibre.
- [5] Average power at  $1 \times 10^{-12}$  BER and a data rate of 4.25Gb/s over 80km fibre.
- [6] Average power at  $1 \times 10^{-10}$  BER and a data rate of 155.55Mb/s
- [7] Between 1260nm and 1520nm minimum receiver sensitivity is reduced by 2dB (-26dBm minimum).
- [8] OSNR measurements are made using an optical spectrum analyser with a resolution bandwidth of 0.1nm and an optical passband filter with a 3dB bandwidth of 1nm.

## Transmitter Operating Specifications – Electrical

Parameter	Symbol	Value			Units	Notes
		Min	Typical	Max		
Data Rate	BR	0.125	2.667	4.25	Gb/s	
Supply Voltage	V <sub>CCTX</sub>	3.13	3.3	3.47	V	
PECL/CML Input	V <sub>TxDIFF</sub>	500		1600	mV	Differential pk-pk Note 1
Input Rise/Fall	T <sub>R</sub> / T <sub>F</sub>			160	ps	20% - 80% Note 1
TX_DISABLE (asserted)	V <sub>DH</sub>	2		3.47	V	Input voltage high
TX_DISABLE (negated)	V <sub>DL</sub>	-0.3		0.8	V	Input voltage low
TX_FAULT (asserted)	V <sub>FH</sub>	2		3.47	V	Output voltage high
TX_FAULT ( negated)	V <sub>FL</sub>	-0.3		0.8	V	Output voltage low

### Notes:

- [1] Test conditions: 100Ω differential (from 100MHz to 2.5GHz);  $V_{TxDIFF} = |(V_{TD+}) - (V_{TD-})|$ .

## APD Receiver Operating Specifications – Electrical

Parameter	Symbol	Value			Units	Notes
		Min	Typical	Max		
Data Rate	BR	0.125	2.667	4.25	Gb/s	
Supply Voltage	V <sub>CC_TX</sub>	3.13	3.3	3.47	V	
Differential Output Swing	V <sub>RXDIFF</sub>	370		2000	mV	Differential pk-pk. Note 1
Rise/Fall Time	T <sub>R</sub> / T <sub>F</sub>			140	ps	20% - 80% Note 1
Loss of Signal (Asserted)	V <sub>OH</sub>	2		3.47	V	Output Voltage High
Loss of Signal (Negated)	V <sub>OL</sub>	-0.3		0.8	V	Output Voltage Low

**Notes:**

[1] Test conditions: 100Ω differential (from 100MHz to 2.5GHz); V<sub>RXDIFF</sub> = | (V<sub>RD+</sub>) - (V<sub>RD-</sub>) |

## Low Speed Electrical Signal Timings

The DWDM SFP MSA document specifies the full details of the low speed electrical interface in Section 3, including timings and both AC and DC requirements.

Table 1: I/O Timing for Hardware Control and Status Functions.

Parameter	Symbol	Min	Max	Unit	Notes
TX_DISABLE Assert Time	t <sub>off</sub>		20	ms	Time from rising edge of TX_DISABLE to when the optical output falls below 10% of nominal
TX_DISABLE Negate Time	t <sub>on</sub>		20	ms	Time from falling edge of TX_DISABLE to when the modulated optical output rises above 90% of nominal
Time to initialize, including reset of TX_FAULT	t <sub>init</sub>		300	ms	From negation of TX_FAULT/INT using TX_DISABLE Optical power going to 90% of final value
Startup time	t <sub>startup</sub>		90	s	From power on to negation of TX_FAULT/INT, indicating laser temperature has stabilised to within operating range.
TX_FAULT/INT Assert Time	t <sub>fault</sub>		50	ms	Time from fault to TX_FAULT/INT on.
TX_DISABLE to Reset	t <sub>reset</sub>	10		ms	Time TX_DISABLE must be held high to reset TX_FAULT/INT
LOS Assert Time	t <sub>los_on</sub>		100	us	Time from LOS state to RX LOS assert
LOS NegateTime	t <sub>los_off</sub>		100	us	Time from non-LOS state to RX LOS deassert
Serial ID Clock Rate	f <sub>serial_clock</sub>		100	kHz	

## Systems Performance Capabilities

The following section demonstrates the typical systems level performance capabilities of the IGF-2811J DWDM SFP Transceiver. The enhanced performance and flexibility of the module is highlighted through operation at various data rates and optical signal to noise ratio (OSNR) levels.

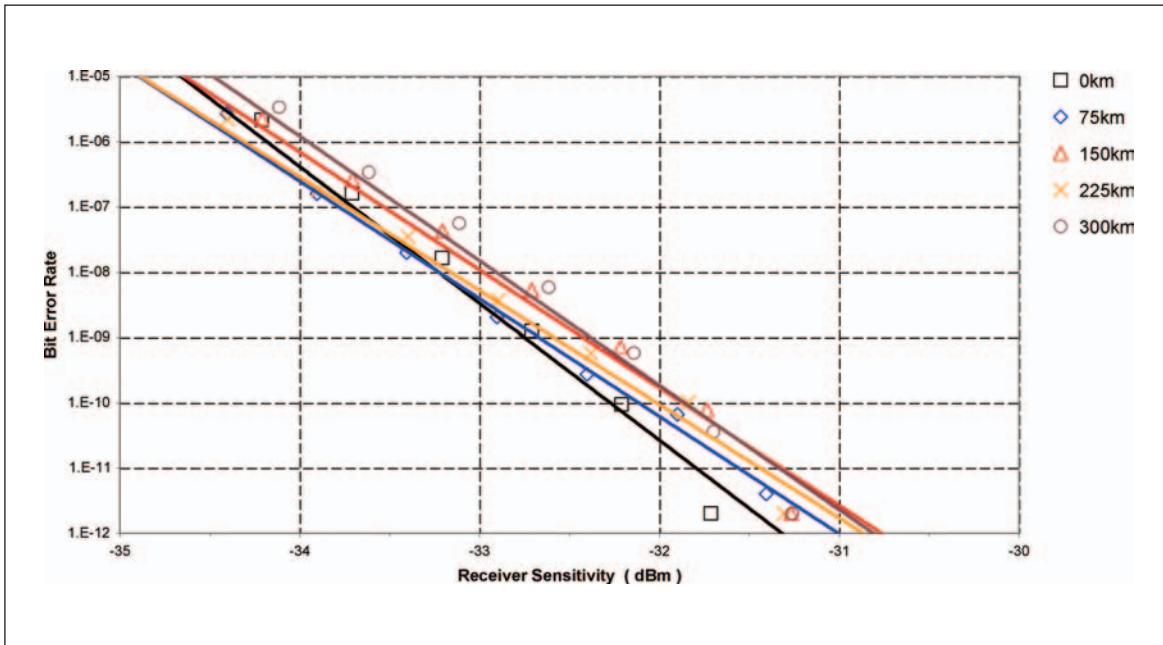

Figure 1: Receiver Sensitivity for OC-48 Transmission over 0km to 300km (30dB OSNR).

### Optical Signal to Noise Ratio (OSNR) Performance

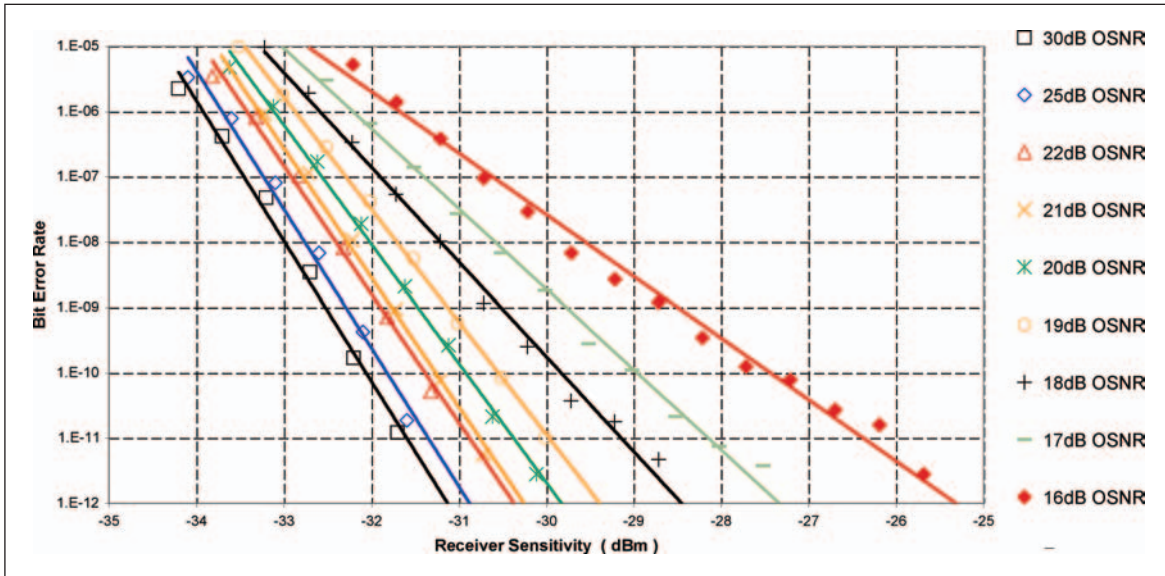

Figure 2: Receiver Sensitivity for OC-48 Transmission under OSNR levels of 30dB to 16dB.

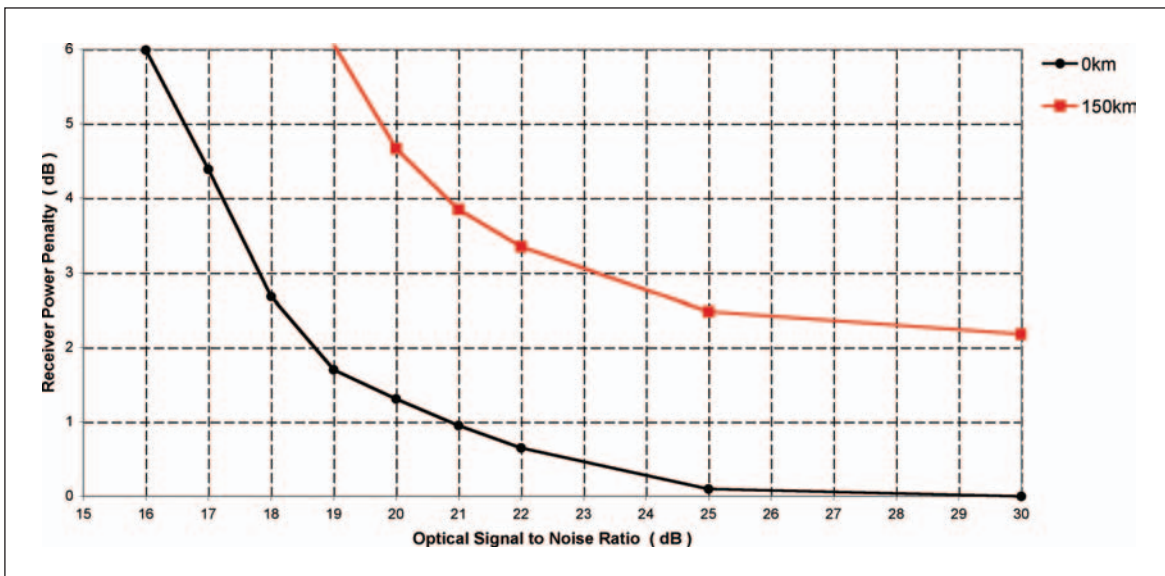

Figure 3: Receiver Power Penalty for OC-48 Transmission under OSNR levels of 30dB to 16dB.



### Multi-rate Performance ( OC-3 & 1xFC )

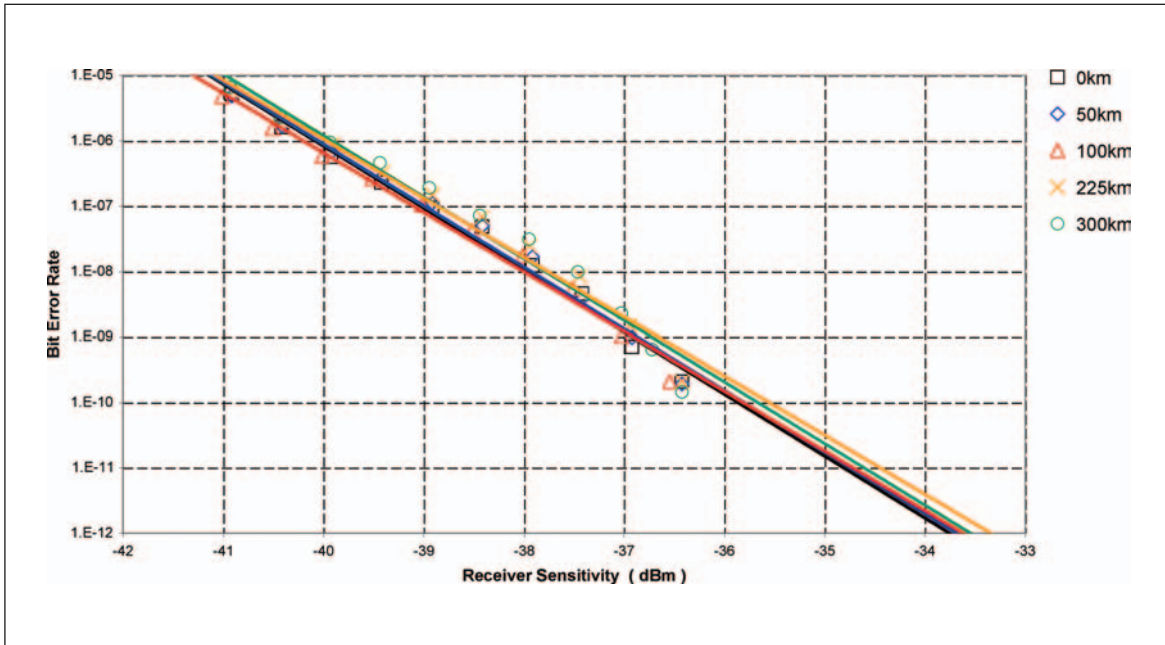

Figure 4: Receiver Sensitivity for OC-3 Transmission over 0km to 300km (30dB OSNR).

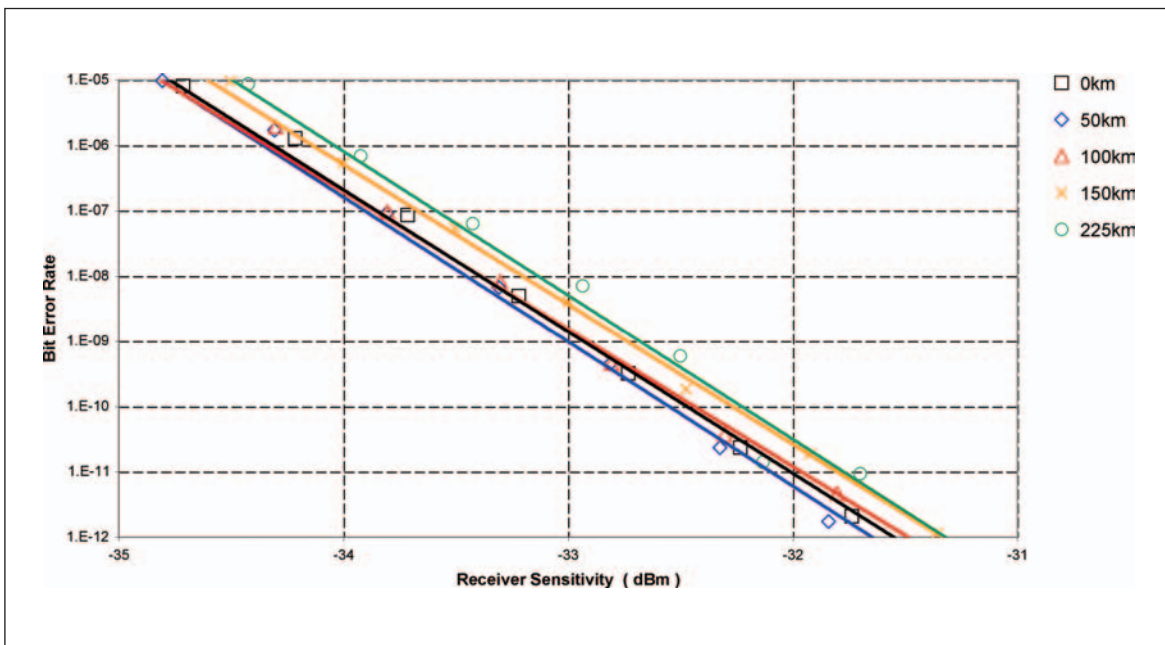

Figure 5: Receiver Sensitivity for 1.063Gb/s Transmission over 0km to 225km (30dB OSNR).

Multi-rate Performance, cont. ( 3.125Gb/s & 4.25Gb/s )

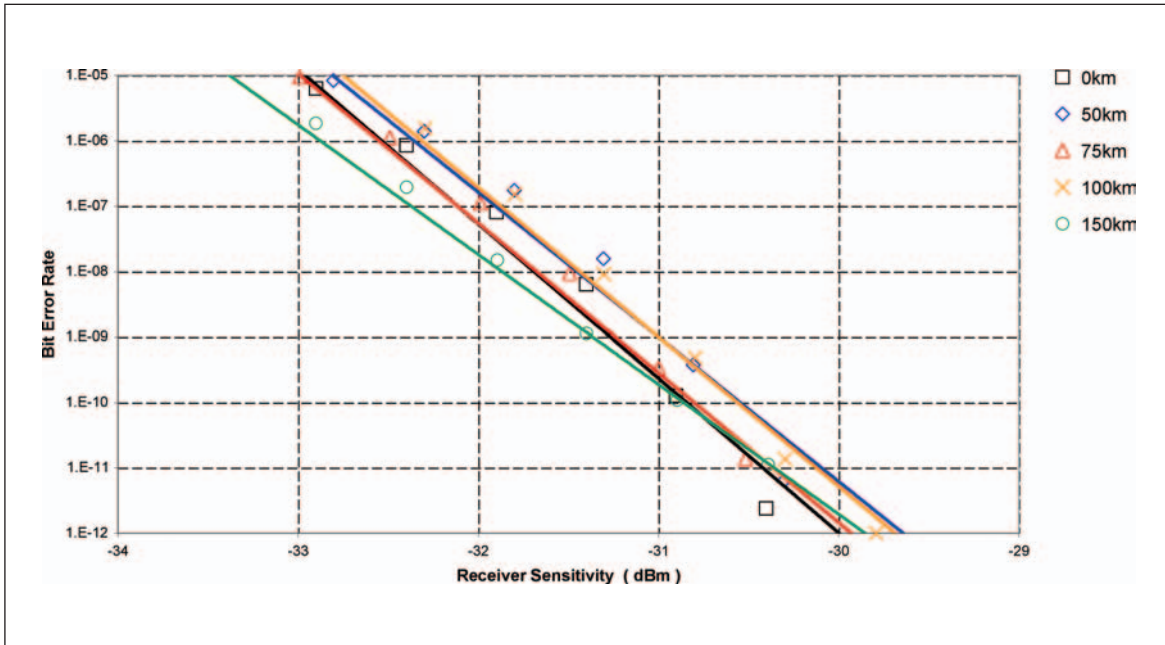

Figure 6: Receiver Sensitivity for 3.125Gb/s Transmission over 0km to 225km (30dB OSNR).

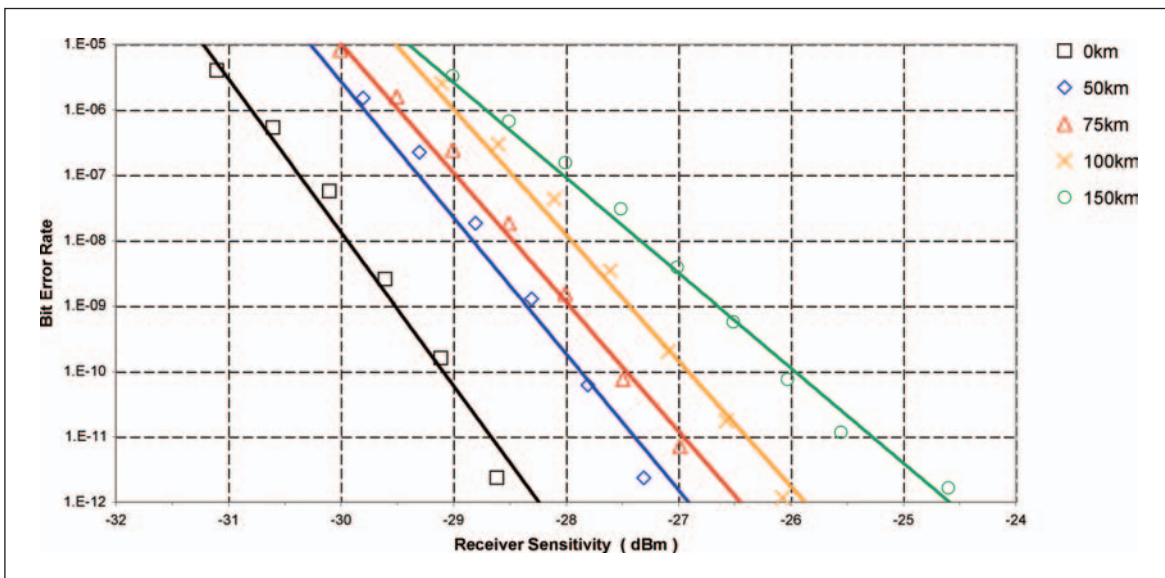

Figure 7: Receiver Sensitivity for 4.25Gb/s FC Transmission over 0km to 150km (30dB OSNR).



## Optical Transmitter Eye Diagrams

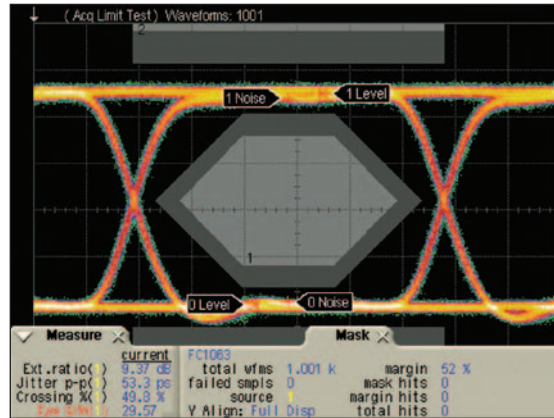

Figure 8: Transmitter Eye Mask for 1G FC at 1.0625Gb/s.

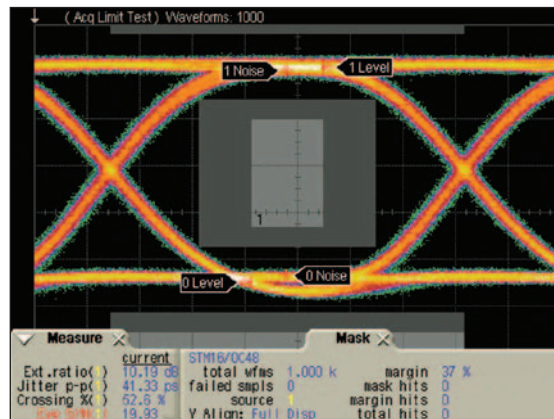

Figure 9: Transmitter Eye Mask for OC-48 at 2.488Gb/s

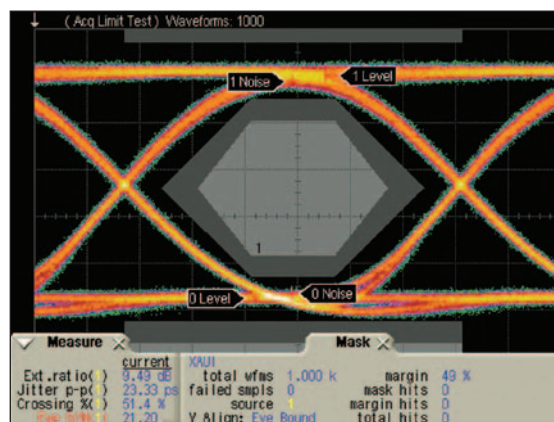

Figure 10: Transmitter Eye Mask for 10GbE XAUI at 3.125Gb/s

## Electrical Pin-out Details

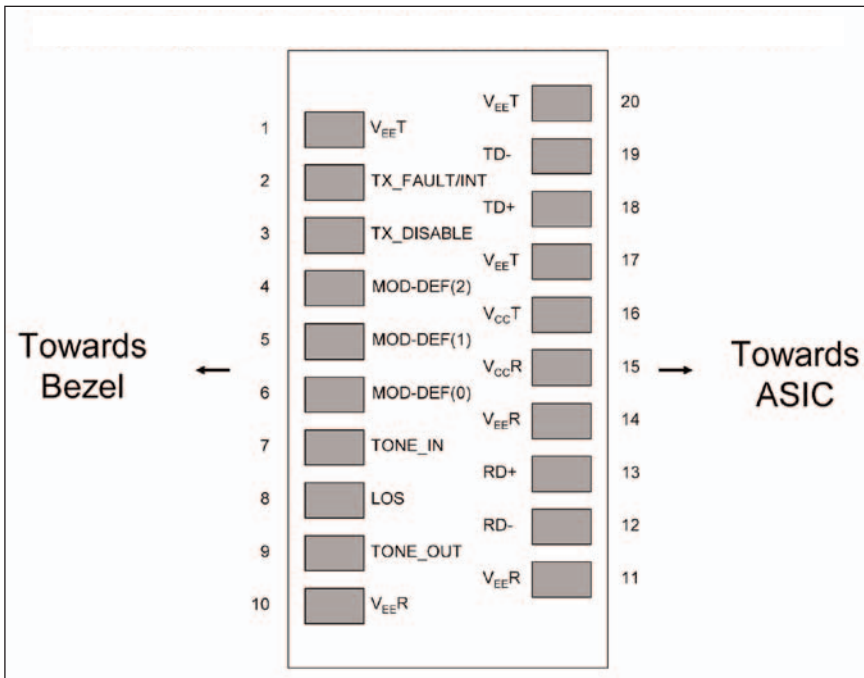

Figure 11: Diagram of Host Board Connector Block Pin Numbers and Names.

Table 2: Pin Definitions and Connection Sequence during Hot Plugging.

Pin Number	Name	Function	Plug Sequence
1	V <sub>EE</sub> T	Transmitter Ground	1
2	TX_FAULT/INT	Transmitter Fault Indicator	3
3	TX_DISABLE	Transmitter Disable	3
4	MOD-DEF(2)	Module Definition 2	3
5	MOD-DEF(1)	Module Definition 1	3
6	MOD-DEF(0)	Module Definition 0	3
7	Tone in	Not Implemented. See note.	3
8	LOS	Loss of Signal	3
9	Tone out	Not Implemented. See note.	1
10	V <sub>EE</sub> R	Receiver Ground	1
11	V <sub>EE</sub> R	Receiver Ground	1
12	RD-	Inverted Received Data Out	3
13	RD+	Received Data Out	3
14	V <sub>EE</sub> R	Receiver Ground	1
15	V <sub>CC</sub> R	Receiver Power	2
16	V <sub>CC</sub> T	Transmitter Power	2
17	V <sub>EE</sub> T	Transmitter Ground	1
18	TD+	Transmit Data In	3
19	TD-	Inverted Transmit Data In	3
20	V <sub>EE</sub> T	Transmitter Ground	1

**Note:** The DWDM MSA provisions for a supervisory tone via pin 7 and pin 9. However, the Bookham DWDM SFP does not currently support this option.

### Mechanical Outline

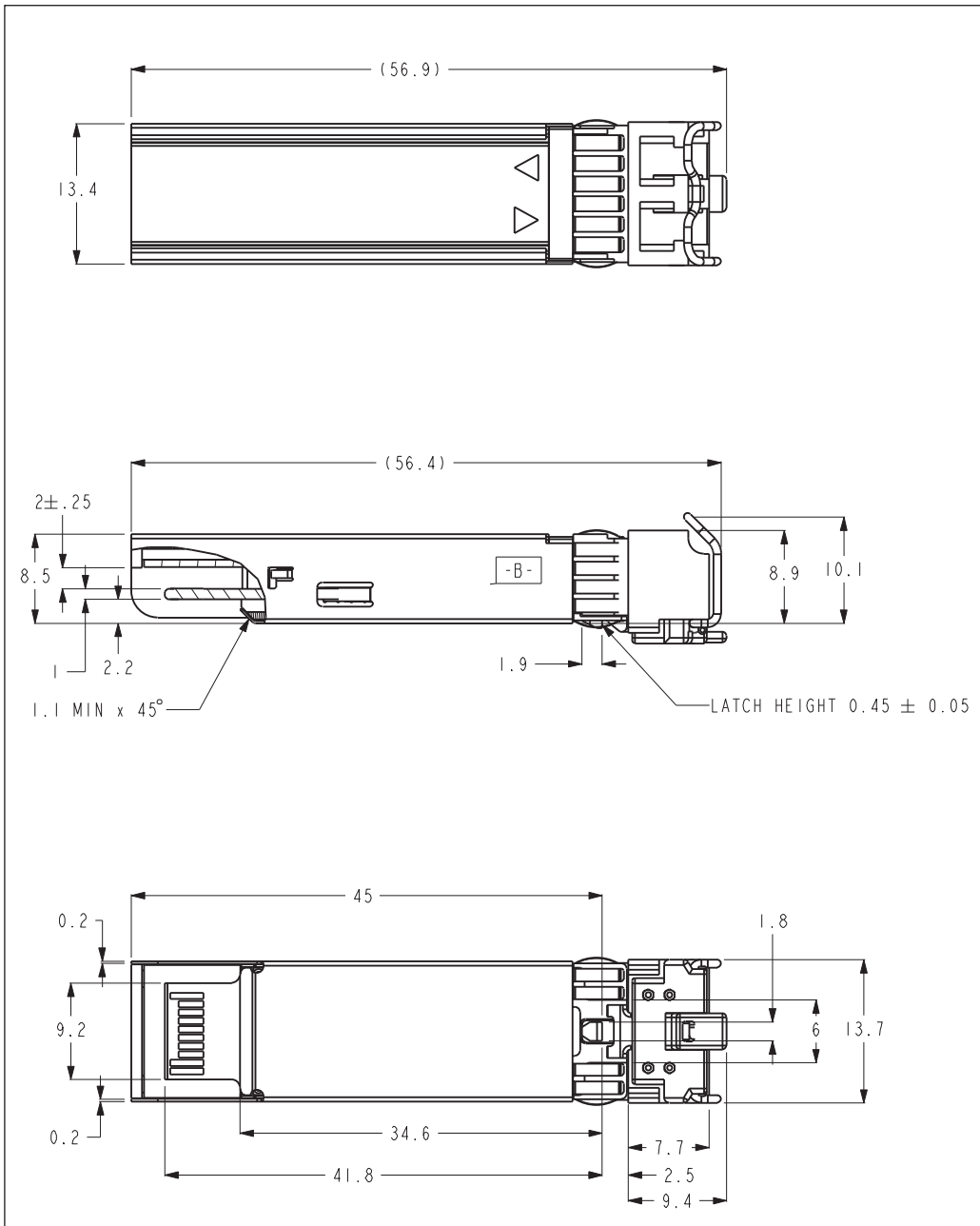

Figure 12: Mechanical outline drawing of DWDM SFP Transceiver.

## Diagnostics specifications

A digital diagnostics interface is available on Bookham SFP transceivers as a 2-wire serial interface and provides user access to module identification data, customer specific data, link type, static and dynamic monitors and a check code mechanism for verifying accuracy in the data registers. These static and dynamic diagnostics allow users to remotely and accurately identify modules and their vendors, enquire about its compatibility with the system and also verify which enhanced diagnostics are supported. The user can also monitor module parameters to determine the module and link condition and provide hardware alerts upon an alarm or warning event.

The Enhanced Digital Diagnostics provide real-time monitoring of receiver input power, transmitter power, internal module temperature, laser bias current and supply voltage parameters.

The 2-wire serial interface is defined by the GBIC (GigaBit Interface Converter) specification and the SFP MSA (Multi-Source Agreement) document dated September 14th, 2000. It is also compliant with the proposed DWDM SFP MSA Document. This interface allows read-only access to two separate memory locations starting at 1010000X (A0h) and 101000X (A2h). Table 3 and Table 4 contain address descriptions and register mapping information for both memory locations.

The memory location starting at A0h (data address 0 ~ 128) contains the Serial ID fields. This is a static data memory location for details such as vendor information, module identification, user specific data and a check code for verifying accuracy in the data registers.

The memory location starting at A2h (data address 0 ~ 255) contains Enhanced Diagnostics fields. The Enhanced Diagnostics are based on the SFF-8472 specification developed in the SFF (Small Form Factor) standards organization with an added TX\_FAULT interrupt feature that provides a hardware alert upon reaching an alarm or warning condition on any, or all, of the diagnostics monitors. Enhanced Diagnostics provide a real-time indication of system and module condition, alerting the user to apparent or pending link or module problems. This is implemented through the use of alarm and warning registers that are updated approximately every 60 milliseconds. Data from these registers are internally calibrated over the specified operating ranges as described in this data sheet. Alarm and warning thresholds are factory preset values and are interpreted as real 16 bit data. The optional TX\_FAULT interrupt feature, if activated, pulls the TX\_FAULT pin (pin 2) high upon reaching an alarm or warning condition on the diagnostics monitors mentioned above. The masking feature allows any of the warning and alarm flags to be dynamically masked by the user.

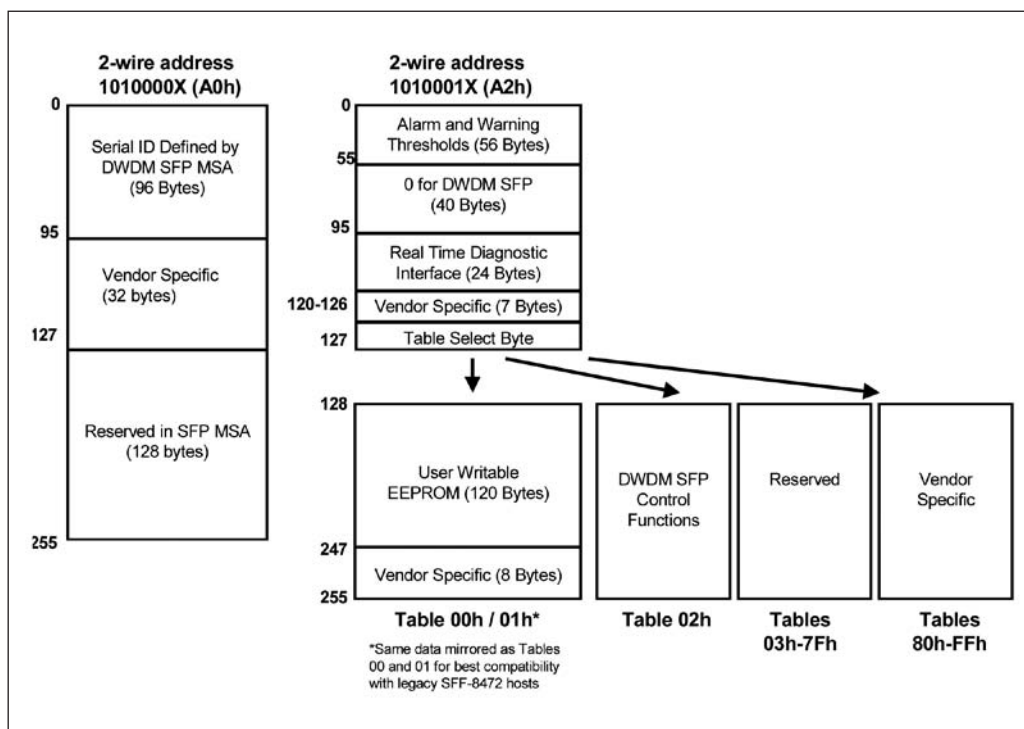

Table 3: DWDM SFP MSA Serial Identification Data Fields (Location A0h).

Data Address (dec)	Field Size (Bytes)	Bookham Module Data (hex)	Name of Field	Description of Field
0	1	0Bh	Identifier	Type of serial transceiver
1	1	27h	Ext. Identifier	Extended identifier of type of serial transceiver
2	1	07h	Connector	Code for connector type
3-10	8	00h,0Ch,44h,00h,80h,10h,01h,00h	Transceiver	Code for electronic compatibility or optical compatibility
11	1	03h	Encoding	Code for serial encoding algorithm
12	1	19h	BR, Nominal	Nominal bit rate, units of 100 Mbits/sec
13-14	2	B4h	Length (9µm) – km	Link length supported for 9/125µm fiber, units in km
15	1	46h	Max Temp	Maximum operating case temperature in °C
16	1	00h	Min Temp	Minimum operating case temperature in °C
17	1	5Fh	Max Supply Current	Maximum supply current in units of 4mA
18	1	-	Reserved	-
19	1	41h	Channel spacing and tuning	Channel spacing compatibility and number of ITU channels supported
20-35	16	42h,4Fh,4Fh,4Bh,48h,41h,4Dh	Vendor Name	SFP transceiver vendor name (ASCII)
36	1	Module dependent	Optional Features	Optional DWDM features (not currently supported by Bookham)
37-39	3	00h 09h A6h	Vendor OUI	SFP transceiver vendor IEEE company ID
40-55	16	Module dependent	Vendor PN	Part number provided by SFP transceiver vendor (ASCII)
56-59	4	03h	Vendor Rev	Revision level for part number provided by vendor (ASCII)
60-61	2	Module dependent	Wavelength	Laser wavelength (in nm)
62	1	Module dependent	Wavelength	Laser wavelength (fractional part in units of 10pm)
63	1	Module dependent	CC_BASE	Check code for Base ID Fields (addresses 0 – 62)
64-65	2	1Ah	Options	Indicates which optional transceiver signals are implemented
66	1	46h	BR, max	Upper bit rate margin, units in %
67	1	5Eh	BR, min	Lower bit rate margin, units in %
68-83	16	Module dependent	Vendor SN	Serial number provided by vendor (ASCII)
84-91	8	Module dependent	Date Code	Vendor's manufacturing date code
92	1	68h	Diagnostics Monitoring Type	Indicates the type of diagnostics implemented in the transceiver
93	1	F0h	Enhanced Options	Indicates which optional enhanced features are implemented
94	1	01h	SFF-8472 Compliance	Indicates which revision of SFF-8472 the transceiver complies with
95	1	Module dependent	CC_EXT	Check code for the Extended ID Fields (addresses 64-94)
96-127	32	-	Vendor Specific	Vendor Specific EEPROM (Vendor specific data; read only)
128-255	128	-	Reserved	Reserved for future use

Table 4: Enhanced Digital Diagnostics Data Fields (Location A2h).

Data Address (dec)	Field Size (Bytes)	Name of Field	Description of Field
<b>A/D Table for Alarm and Warning Thresholds</b>			
00-55	56	High/Low Alarm and Warning Levels	Specifies factory preset alarm and warning thresholds defined in <b>Table 5</b> .
<b>Calibration Constants for External Calibration Option</b>			
56-94	39		Unused in DWDM devices. All Bytes Set to 0.
95	1	Checksum	Low order 8 bits of the sum of bytes 0-94
<b>A/D Values and Status Bits</b>			
96-109	8	A/D Values	Real-time A/D binary values of the following enhanced diagnostics: module temperature, supply voltage, laser bias current, transmit optical power, receive optical power, laser temperature and TEC current. These values are Internally calibrated absolute measurements. All diagnostic parameters implemented in these address locations have a corresponding high and low, alarm and warning thresholds assigned in address locations 00-55.
<b>Optional Status/Control Bits</b>			
110	1	Soft Control Signals	“Soft” control signals monitored over the 2-wire access port. Continuously updated real-time status of the following control signals: TX_FAULT, TX_DISABLE, Rate Select, and LOS. Last bit (LSB) indicates transceiver readiness to transmit data.
111	1	Reserved	Reserved
<b>Reserved Optional Alarm and Warning Flag Bits</b>			
112-117	5	Alarm & Warning Flags	Real time, single point bits indicating module parameters that are approaching or outside normal operating limits. Parameters monitored are: module temperature, supply voltage, laser bias current, transmit optical power, receive optical power, laser temperature and TEC current. The flags are internally calibrated thresholds with limits corresponding to levels detailed in addresses 00-39 above.
118-119	2	Warning Mask	Masking bits corresponding to Warning bits of bytes 116 and 117 respectively
<b>Vendor Specific Memory Addresses</b>			
120-126	8	Vendor Specific	Vendor specific data
<b>Table Select Byte (2-wire Address A2h)</b>			
127	1	Table Select	The byte value defines the Table location for subsequent reads and writes to bytes locations 128-255
<b>User EEPROM</b>			
128-247	120	User EEPROM	User writable EEPROM
248-255	8	Vendor Specific	Vendor specific control functions

Table 5: Alarm and Warning Thresholds.

Address	Value	Description
00-01	85 °C	Temp High Alarm
02-03	-10 °C	Temp Low Alarm
04-05	80 °C	Temp High Warning
06-07	-5 °C	Temp Low Warning
08-09	3.63 V	VCC High Alarm
10-11	2.97 V	VCC Low Alarm
12-13	3.47 V	VCC High Warning
14-15	3.14 V	VCC Low Warning
16-17	70 mA	Bias High Alarm
18-19	10 mA	Bias Low Alarm
20-21	55 mA	Bias High Warning
22-23	15 mA	Bias Low Warning
24-25	3162µW	Tx Power High Alarm
26-27	1259µW	Tx Power Low Alarm

Address	Value	Description
28-29	2512µW	Tx Power High Warning
30-31	1585µW	Tx Power Low Warning
32-33	200µW	Rx Power High Alarm
34-35	0.794µW	Rx Power Low Alarm
36-37	126µW	Rx Power High Warning
38-39	1.585µW	Rx Power Low Warning
40-41	60 °C	Laser Temp High Alarm
42-43	30 °C	Laser Temp Low Alarm
44-45	55 °C	Laser Temp High Warning
46-47	35 °C	Laser Temp Low Warning
48-49	600 mA	TEC Current High Alarm
50-51	-600 mA	TEC Current Low Alarm
52-53	400 mA	TEC Current High Warning
54-55	-400 mA	TEC Current Low Warning



## Regulatory Compliance

Bookham IGP-28111J SFP transceiver is designed to be Class I Laser safety compliant and is certified per the following standards:

Feature	Agency	Standard	Certificate / Comments
Laser Safety	FDA/CDRH	CDRH 21J CFR1040.10	Pass. Accession no. 0522631-00
	TUV	IEC/EN60825-1:2001	US-TUVR-3209
		CAN/CSA-60825-1-03	CU7206220601
Product Safety	TUV	UL60950-1:2001	CU7206220601
		CAN/CSA-C22.2 No.60950-1-03	CU7206220601
		IEC/EN60950-1:2001	US-TUVR-3209
EMC	FCC	Title 47, Part 15, 1-12.5 GHz, Class B	Pass

## RoHS Compliance

Bookham is fully committed to environment protection and sustainable development and has set in place a comprehensive program for removing polluting and hazardous substances from all of its products. The relevant evidence of RoHS compliance is held as part of our controlled documentation for each of our compliant products. RoHS compliance parts are available to order, please refer to the ordering information section for further details.

## Package and Handling Instructions

### Process Plug

It is important to note that single mode optics, as with all optical devices are susceptible to contamination from air borne particles, human body oils, and mating connector particles. Care should be taken to protect all exposed optical interfaces with process plugs and dust covers. All Bookham IGP-2000 SFP products are supplied with a process plug. This plug protects the transceiver's optics during standard handling and manufacturing processes. It is recommended that the process plug remain in the transceiver whenever an optical fibre connector is not inserted.

### ESD Discharge (ESD)

Normal ESD precautions are required during the handling of this module. This transceiver is shipped in ESD protective packaging and it should not be removed from its packaging or otherwise handled unless in an ESD protected environment utilizing standard grounded benches, floor mats, and wrist straps.

### Eye Safety

The Bookham IGP-2000 Series SFP products are Class I laser products per IEC/EN60950-1:2001 and 60825-1:2001, and are certified per CDRH, 21 CFR 1040, Laser Safety Requirements. It is an eye safe device when operated within the limits of this specification. Operating this product in a manner inconsistent with intended usage and specification may result in hazardous radiation exposure. Tampering with this laser based product may warrant, under law, re-certification of the modified product as required by the U.S. Food and Drug Administration (21 CFR 1040).

## Related Documents

1. DWDM SFP MSA (MultiSource Agreement), Revision 1.0, 19th September 2005.
2. SFP MSA (MultiSource Agreement), 14th September 2000.
3. Digital Diagnostics Monitoring Interface for Optical Transceivers. SFF Document Number SFF-8472, Rev 9.5.
4. Telcordia GR-253-CORE.
5. ITU G.957.
6. IEEE 802.3ae, 2000 Edition.

## Ordering information

The specific product order codes for each ITU-T 100GHz channel available are defined below in Table 6 for C-Band and Table 7 for L-Band.

Table 6: IGP-28111J Product Order Codes for C-Band Wavelengths.

Product Code	Frequency (THz)	Wavelength (nm)
IGP-28111J-60	196.00	1529.55
IGP-28111J-59	195.90	1530.33
IGP-28111J-58	195.80	1531.12
IGP-28111J-57	195.70	1531.90
IGP-28111J-56	195.60	1532.68
IGP-28111J-55	195.50	1533.47
IGP-28111J-54	195.40	1534.25
IGP-28111J-53	195.30	1535.04
IGP-28111J-52	195.20	1535.82
IGP-28111J-51	195.10	1536.61
IGP-28111J-50	195.00	1537.40
IGP-28111J-49	194.90	1538.19
IGP-28111J-48	194.80	1538.98
IGP-28111J-47	194.70	1539.77
IGP-28111J-46	194.60	1540.56
IGP-28111J-45	194.50	1541.35
IGP-28111J-44	194.40	1542.14
IGP-28111J-43	194.30	1542.94
IGP-28111J-42	194.20	1543.73
IGP-28111J-41	194.10	1544.53
IGP-28111J-40	194.00	1545.32
IGP-28111J-39	193.90	1546.12
IGP-28111J-38	193.80	1546.92

Product Code	Frequency (THz)	Wavelength (nm)
IGP-28111J-37	193.70	1547.72
IGP-28111J-36	193.60	1548.51
IGP-28111J-35	193.50	1549.32
IGP-28111J-34	193.40	1550.12
IGP-28111J-33	193.30	1550.92
IGP-28111J-32	193.20	1551.72
IGP-28111J-31	193.10	1552.52
IGP-28111J-30	193.00	1553.33
IGP-28111J-29	192.90	1554.13
IGP-28111J-28	192.80	1554.94
IGP-28111J-27	192.70	1555.75
IGP-28111J-26	192.60	1556.55
IGP-28111J-25	192.50	1557.36
IGP-28111J-24	192.40	1558.17
IGP-28111J-23	192.30	1558.98
IGP-28111J-22	192.20	1559.79
IGP-28111J-21	192.10	1560.61
IGP-28111J-20	192.00	1561.42
IGP-28111J-19	191.90	1562.23
IGP-28111J-18	191.80	1563.05
IGP-28111J-17	191.70	1563.86
IGP-28111J-16	191.60	1564.68

Table 7: IGP-28111J Product Order Codes for L-Band Wavelengths.

Product Code	Frequency (THz)	Wavelength (nm)	Product Code	Frequency (THz)	Wavelength (nm)
IGP-28111J-09	190.90	1570.42	IGP-28111J-87	188.70	1588.73
IGP-28111J-08	190.80	1571.24	IGP-28111J-86	188.60	1589.57
IGP-28111J-07	190.70	1572.06	IGP-28111J-85	188.50	1590.41
IGP-28111J-06	190.60	1572.89	IGP-28111J-84	188.40	1591.26
IGP-28111J-05	190.50	1573.71	IGP-28111J-83	188.30	1592.10
IGP-28111J-04	190.40	1574.54	IGP-28111J-82	188.20	1592.95
IGP-28111J-03	190.30	1575.37	IGP-28111J-81	188.10	1593.79
IGP-28111J-02	190.20	1576.20	IGP-28111J-80	188.00	1594.64
IGP-28111J-01	190.10	1577.03	IGP-28111J-79	187.90	1595.49
IGP-28111J-00	190.00	1577.86	IGP-28111J-78	187.80	1596.34
IGP-28111J-99	189.90	1578.69	IGP-28111J-77	187.70	1597.19
IGP-28111J-98	189.80	1579.52	IGP-28111J-76	187.60	1598.04
IGP-28111J-97	189.70	1580.35	IGP-28111J-75	187.50	1598.89
IGP-28111J-96	189.60	1581.18	IGP-28111J-74	187.40	1599.75
IGP-28111J-95	189.50	1582.02	IGP-28111J-73	187.30	1600.60
IGP-28111J-94	189.40	1582.85	IGP-28111J-72	187.20	1601.46
IGP-28111J-93	189.30	1583.69	IGP-28111J-71	187.10	1602.31
IGP-28111J-92	189.20	1584.53	IGP-28111J-70	187.00	1603.17
IGP-28111J-91	189.10	1585.37	IGP-28111J-69	186.90	1604.03
IGP-28111J-90	189.00	1586.20	IGP-28111J-68	186.80	1604.89
IGP-28111J-89	188.90	1587.04	IGP-28111J-67	186.70	1605.74
IGP-28111J-88	188.80	1587.88	IGP-28111J-66	186.60	1606.61

## Contact Information

### North America Bookham Worldwide Headquarters

2584 Junction Ave.  
San Jose  
CA 95134  
USA

- Tel: +1 408 919 1500
- Fax: +1 408 919 6083

[www.bookham.com](http://www.bookham.com)  
[sales@bookham.com](mailto:sales@bookham.com)

### Europe Paignton Office

Brixham Road  
Paignton  
Devon  
TQ4 7BE  
United Kingdom

- Tel: +44 (0) 1803 66 2000
- Fax: +44 (0) 1803 66 2801

### Asia Shenzhen Office

2 Phoenix Road  
Futian Free Trade Zone  
Shenzhen 518038  
China

- Tel: +86 755 33305888
- Fax: +86 755 33305805  
+86 755 33305807

### Important Notice

Performance figures, data and any illustrative material provided in this data sheet are typical and must be specifically confirmed in writing by Bookham before they become applicable to any particular order or contract. In accordance with the Bookham policy of continuous improvement specifications may change without notice. The publication of information in this data sheet does not imply freedom from patent or other protective rights of Bookham or others. Further details are available from any Bookham sales representative.