

## Low Cost Six-Way SMT Power Divider 1700 - 2000 MHz



### Features

- Small Size, Low Profile
- Superior Repeatability (Lot-to-lot Variation)
- Industry Standard SOIC-16 SMT Plastic Package
- Typical Isolation 25dB
- Typical Insertion Loss 1.0dB
- Low Cost

### Description

M/A-COM's DS56-0006 is an IC-based monolithic power splitter/combiner in a low cost SOIC-16 plastic package. This 6-way power divider is ideally suited for applications where PCB real estate is at a premium and standard packaging for automated assembly and low cost are critical. Typical applications include base stations, portables, and peripheral devices (PCMCIA cards) for wireless standards such as PCS, PCN, DECT, PHS, and DCS-1800. Available in Tape and Reel.

The DS56-0006 is fabricated using a passive-integrated circuit process. The process features full-chip passivation for increased performance and reliability.

1. All specifications apply with a 50-Ohm source and load impedance.

### Typical Electrical Specifications<sup>1</sup>, T<sub>A</sub> = +25°C

Parameter	Units	Min	Typ	Max
Insertion Loss above 7.8dB				
1700—2000 MHz	dB	—	1.3	1.8
1850—1910 MHz	dB	—	1.0	1.5
Isolation				
1700—2000 MHz	dB	18	25	—
1850—1910 MHz	dB	21	26	—
VSWR Input				
1700—2000 MHz	—	—	1.7 : 1	2.0 : 1
1850—1910 MHz	—	—	1.3 : 1	1.7 : 1
Output				
1700—2000 MHz	—	—	1.3 : 1	1.7 : 1
1850—1910 MHz	—	—	1.1 : 1	1.3 : 1
Amplitude Balance				
1700—2000 MHz	dB	—	0.8	1.3
1850—1910 MHz	dB	—	1.0	1.3
Phase Balance				
1700—2000 MHz	°	—	10	20
1850—1910 MHz	°	—	8	16

V2.00

### SOIC-16

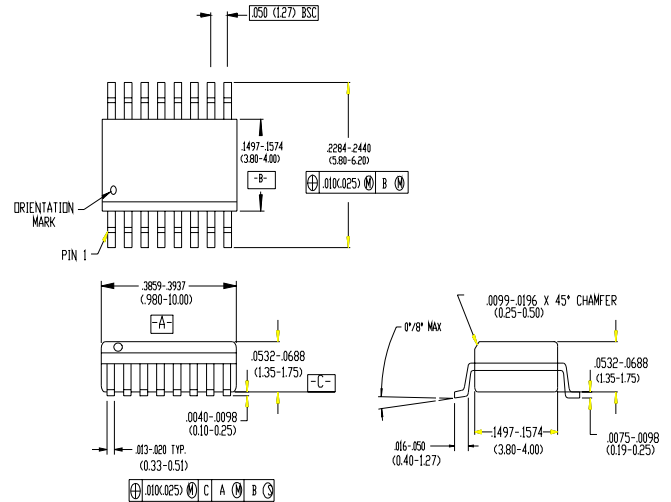

### Ordering Information

Part Number	Package
DS56-0006	SOIC-16 Lead Plastic Package
DS56-0006-TR	Forward Tape and Reel <sup>1</sup>
DS56-0006-RTR	Reverse Tape and Reel <sup>1</sup>

1. If specific reel size is required, consult factory for part number assignment.

# Absolute Maximum Ratings<sup>1</sup>

Parameter	Absolute Maximum
Input Power <sup>2</sup>	1 W CW
Operating Temperature	-40°C to +85°C
Storage Temperature	-65°C to +150°C

1. Exceeding these limits may cause permanent damage.
2. With internal load dissipation of 0.125 W Maximum.

# Functional Diagram

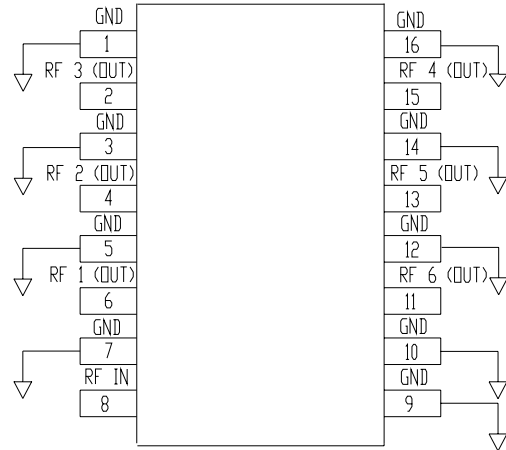

# Typical Performance @ +25°C

**Insertion Loss**

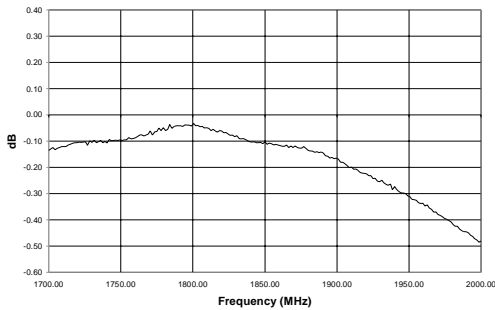

**Amplitude Imbalance**

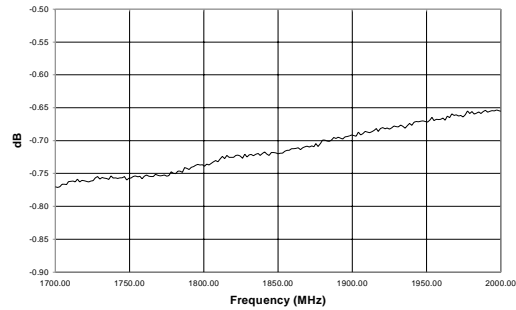

**Isolation**

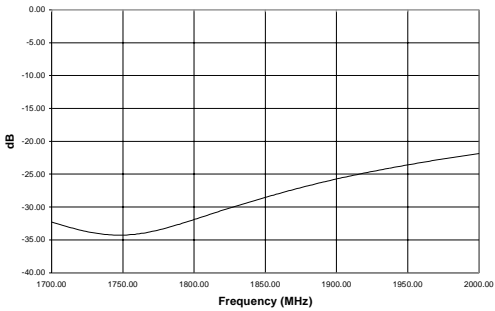

**Phase Imbalance**

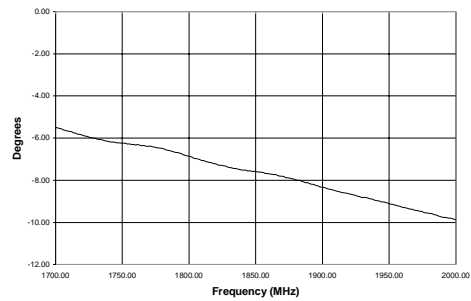

**Input VSWR**

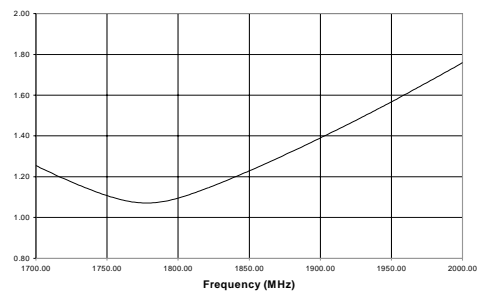

**Output VSWR**

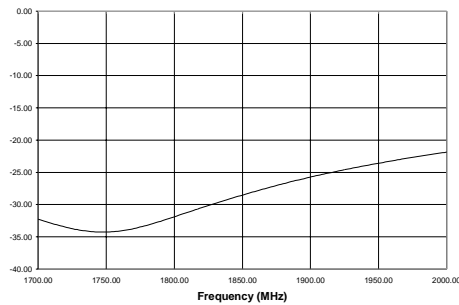

M/A-COM Division of AMP Incorporated ■ North America: Tel. (800) 366-2266, Fax (800) 618-8883 ■ Asia/Pacific: Tel. +85 2 2111 8088, Fax +85 2 2111 8087 ■ Europe: Tel. +44 (1344) 869 595, Fax+44 (1344) 300 020

www.macom.com

AMP and Connecting at a Higher Level are trademarks. Specifications subject to change without notice.

