

SPECIFICATION

Patent Pending

Part Number:	PA.711.A
Product Name:	Warrior II Ultra Wide-Band LTE/Cellular/CDMA SMT Antenna Pairs with the PA.710.A Warrior for 4G MIMO applications LTE / GSM / CDMA /DCS /PCS / WCDMA / UMTS / HSDPA / GPRS / EDGE /IMT, 698MHz to 960MHz, 1710MHz to 2690MHz, 5000 to 5850MHz
Features:	Supplied as one part of a MIMO pair with PA.710.A on MIMO applications High isolation and ECC when used with PA.710.A on specific board layouts High Efficiency Wide-Band Antenna Patent Pending Surface Mount Technology 40x6x5mm dimensions RoHS Compliant ✓



1 INTRODUCTION

The PA.711.A is the culmination of a multi-year research effort in MIMO antennas. It has been designed specifically to be used as the second antenna in a 2*2 or higher MIMO setup in conjunction with our standard PA.710.A LTE antenna. The PA.711.A has all the same attributes of the PA.710.A, a high efficiency SMT Ceramic antenna, operating at 698MHz to 960MHz and 1710MHz to 2690MHz. Due to subtle variation of radiation pattern it delivers high isolation and ECC <0.3 when used with the PA.710.A in certain layouts. This decreases the footprint needed for LTE MIMO applications compared to using other antennas. The PA.711.A is delivered on tape and reel and mounted securely during the device PCB reflow process.

Note for single antenna applications use PA.710.A.

PAD.71X.A Evaluation Board/MIMO Antenna System

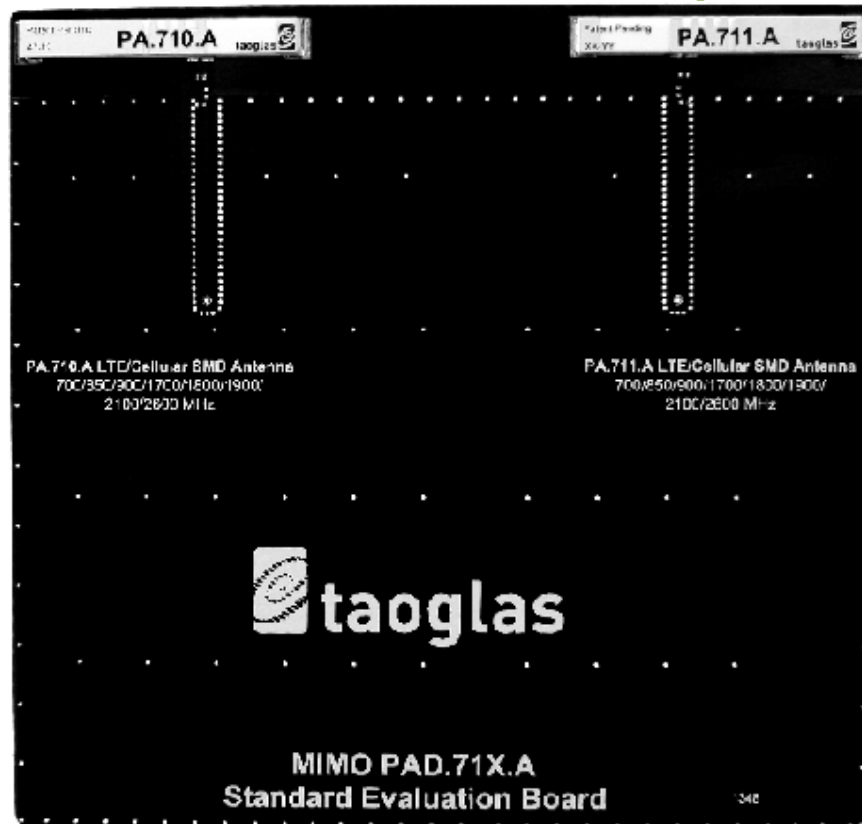

Figure 1. MIMO PAD.71X Standard Evaluation Board

The MIMO PAD.71X.A Standard Evaluation board has two antenna elements; The existing PA.710 LTE MIMO ceramic antenna, successfully used in many LTE MIMO devices today, along with its brother the PA.711.A LTE MIMO ceramic antenna. The evaluation board is just 125mm*120mm

(much smaller than can be achieved using most other passive antenna technologies, which would require board sizes of 200mm*200mm to achieve the same isolation/ECC). It can be ordered from Taoglas and can also be used as a stand-alone 2*2 MIMO antenna for your application.

By altering the radiation pattern of the PA.711.A to that of the PA.710.A (similar to reflecting), Taoglas has created the world's first high efficiency MIMO embedded wide-band cellular antenna conforming to an envelope correlation co-efficient of below 0.3. This minimal self-interference is critical to achieve high data rates in today's advanced LTE systems.

The patent pending antenna is ideal for integration into high data throughput devices which depend on high efficiency MIMO antennas.

Typical applications of PAD.71X are

- Intelligent Transport Systems
- High Definition Video Broadcast Systems
- Wireless LTE MIMO M2M devices with legacy 2G/3G Functionality

Top View

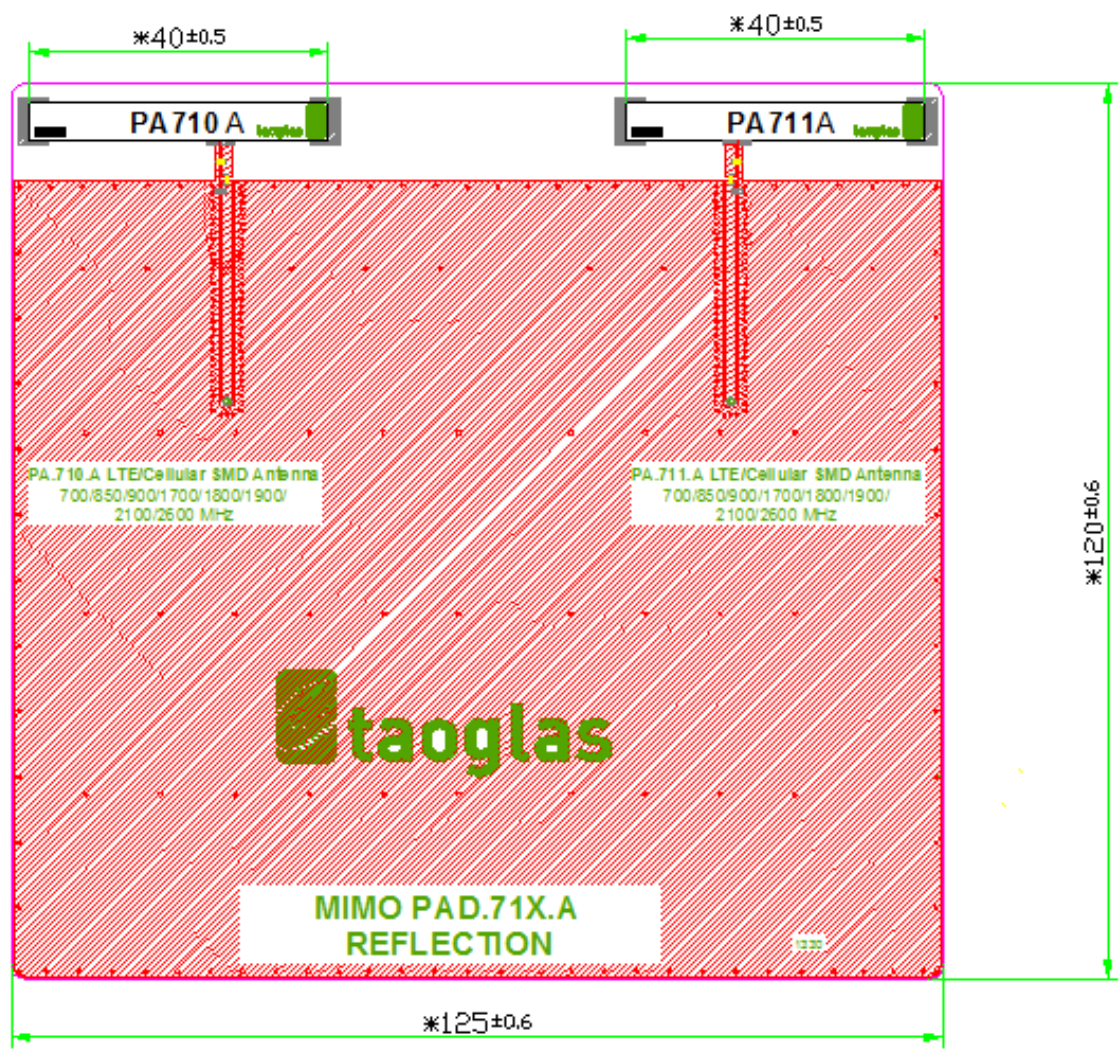

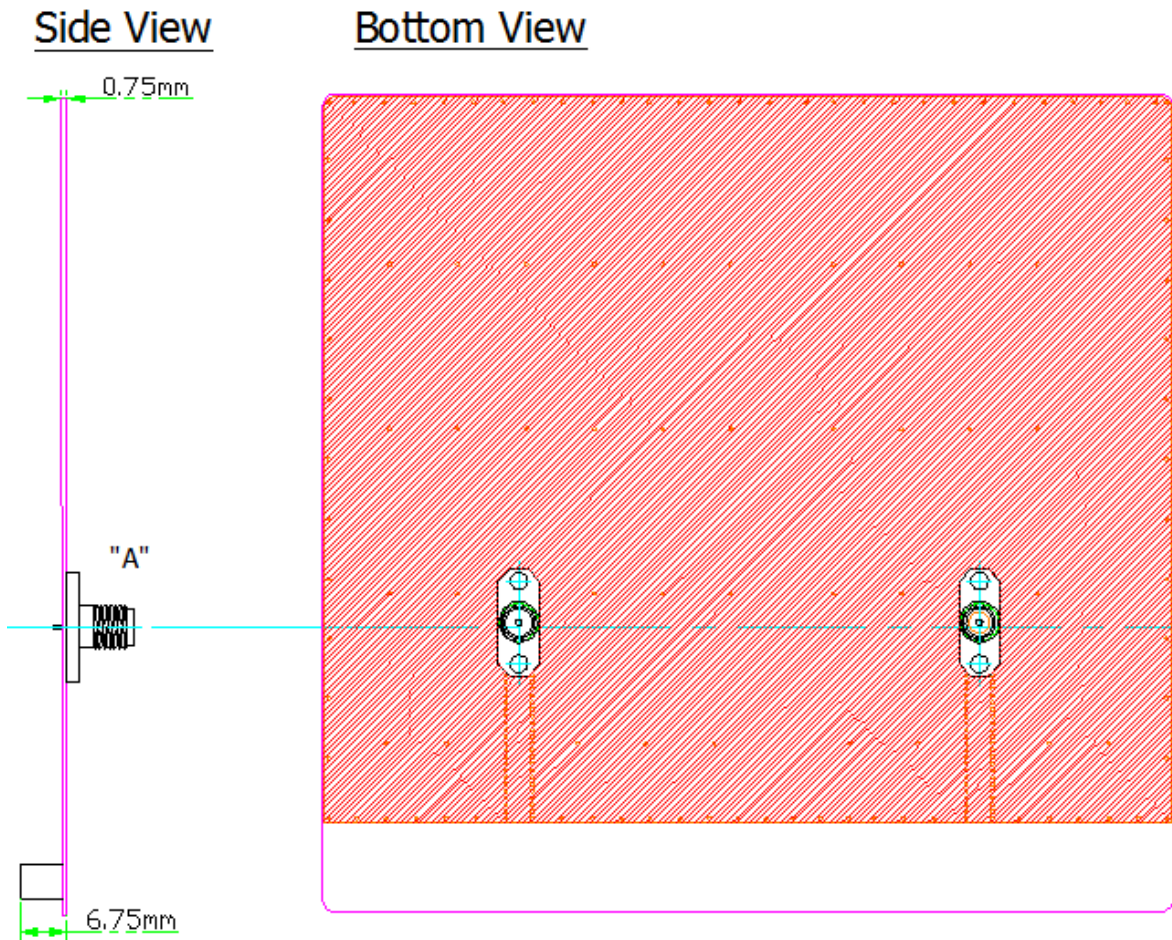

Figure 2. PAD.71X.A Mechanical Drawing

For PAD.71X.A, antenna board size, dimensions, and antenna placement have all been carefully evaluated for optimum performance. It is not recommended to reduce the antenna board dimensions, as efficiency will reduce dramatically along with poor isolation. The antennas may also need to be re-matched to fit into different custom enclosures. Taoglas offers full customization of the antenna system for your device.

Alternatively, PA.710 and PA.711 can be integrated directly on your main board, provided that you follow strict guidelines on meeting minimum main-board ground plane dimensions, transmission line design, matching, and placement of antennas. Contact Taoglas regional sales office for support before you start your design.

1.1 Key Advantages

1. **Highest efficiency in a small size, i.e. 40mm*6mm*5mm.** A comparative antenna, for example metal/FR4/FPC/whip/rod/helix, would have much reduced efficiency in this configuration due to their different dielectric constants. Very high efficiency antennas are critical to 3G and 4G devices ability to deliver the stated data-speed rates of systems such as HSPA and LTE.
2. **More resistant to detuning compared to other antenna integrations.** If tuning is required it can be tuned for the device environment using a matching circuit, or other techniques on the main PCB itself. There is no need for new tooling, thereby saving money if customization is required.
3. **Highly reliable and robust.** Our PA series antennas are used by the world's leading automotive makers in extremely challenging environments. The antenna meets all temperature and mechanical specs required (vibration, drop tests, etc).
4. **Easy to integrate.** Other antenna designs come in irregular shapes and sizes making them more difficult to integrate.
5. **Surface Mount Technology (Directly On-Board).** The PA.711.A antenna saves on labour, cable and connector costs, leads to higher integration yield rates, and reduces losses in transmission.
6. **Minimum Transmission and Reception Losses.** These are kept to absolute minimum resulting in much improved OTA (over the air), i.e. TRP (Total Radiated Power)/TIS (Total Isotropic Radiation), device performance compared to similar efficiency cable and connector antenna solutions. This means it is an ideal antenna to be used for devices that need to pass, for example, USA carrier network approvals.
7. **RSE Reductions.** The PA.711.A will help to eliminate radiated spurious emission failures compared to other antenna technologies as the required layout for the antenna can deliver natural isolation between the onboard noise and the antenna itself. Also, the antenna can be matched better to the system with the matching circuit function.
8. **High Gain in Both Polarization Planes.** Achieves moderate to high gain in both vertical and horizontal polarization planes. This feature is very useful in certain wireless communications where the antenna orientation is not fixed and the reflections or multipath signals may be present from any plane. In those cases the important parameter to be considered is the total field strength,

which is the vector sum of the signal from the horizontal and vertical polarization planes at any instant in time.

2 SPECIFICATION

ELECTRICAL					
ANTENNA	PA.711.A				
STANDARD	2G/3G/4G				
Operation Frequency (MHz)	698~960MHz	1710~2170MHz	2300~2400MHz	2490~2690MHz	5000~5850MHz
Peak Gain	1.0dBi	2.9dBi	4.1dBi	2.8dBi	4dBi
Average Gain	-2.8dB	-2.6dB	-2.0dB	-2.2dB	-1.5dB
Efficiency	52%	54%	62%	61%	70%
VSWR	<3.0:1				
Impedance	50Ω				
Polarization	Linear				
Radiation Properties	Omni-directional				
Max Input Power	5 W				

- The PA.711 antenna performance was measured with Taoglas PAD.71X.A EVB.

MECHANICAL	
Dimensions (mm)	40 x 6 x 5 mm
Material	Ceramic
Termination	Ag (environmental-friendly Pb free)
EVB Connector	SMA-Female
ENVIRONMENTAL	
Operation Temperature	-40°C to 85°C
Storage Temperature	-40°C to 105°C
Relative Humidity	Non-condensing 65°C 95% RH
RoHs Compliant	Yes

3 TEST SET UP

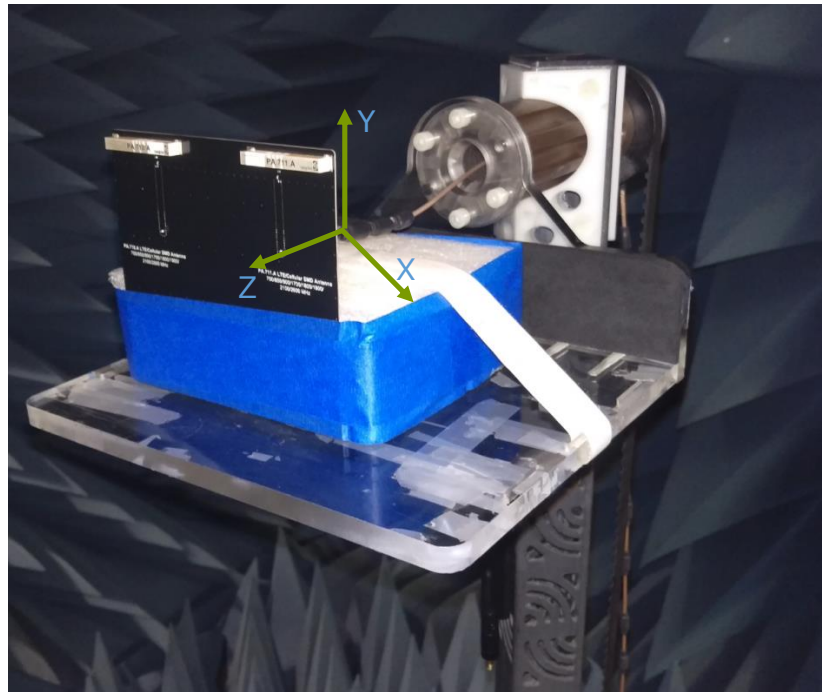
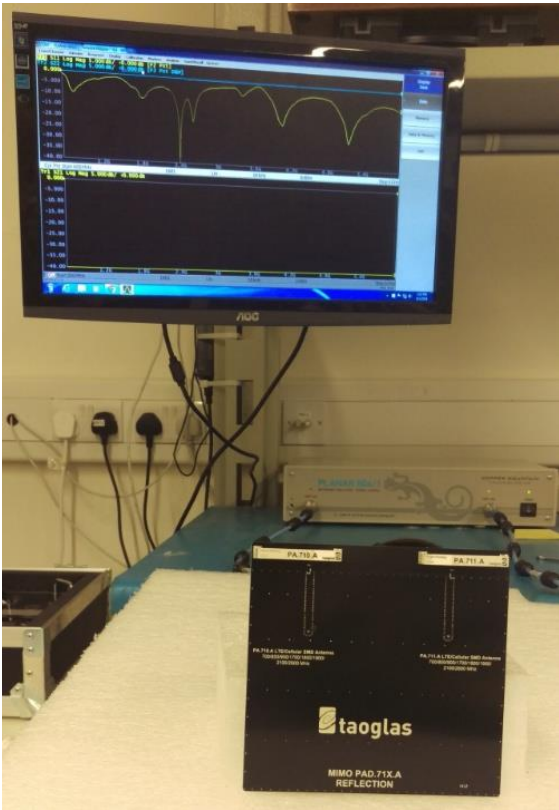

Figure 3. S-parameter S_{11} measurements (left hand) and peak gain, average gain, efficiency, and radiation pattern measurements in Taoglas Ireland ETS-Lindgren OTA Chamber (right hand)

4 ANTENNA PARAMETERS

4.1 S-Parameter: S_{11}

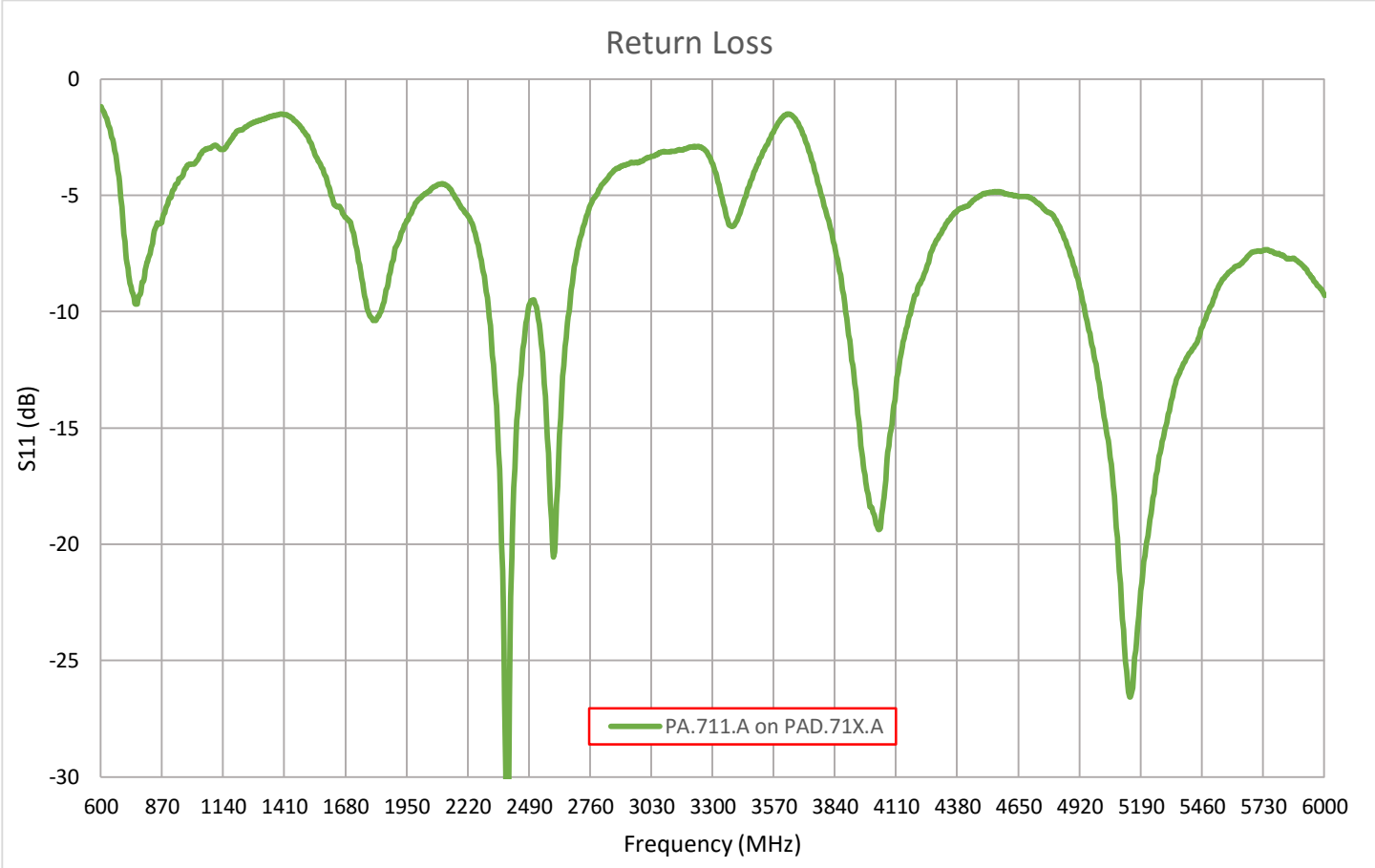

Figure 4. S_{11} of the PA.711.A LTE Antenna on MIMO PAD.71X.A

4.2 VSWR

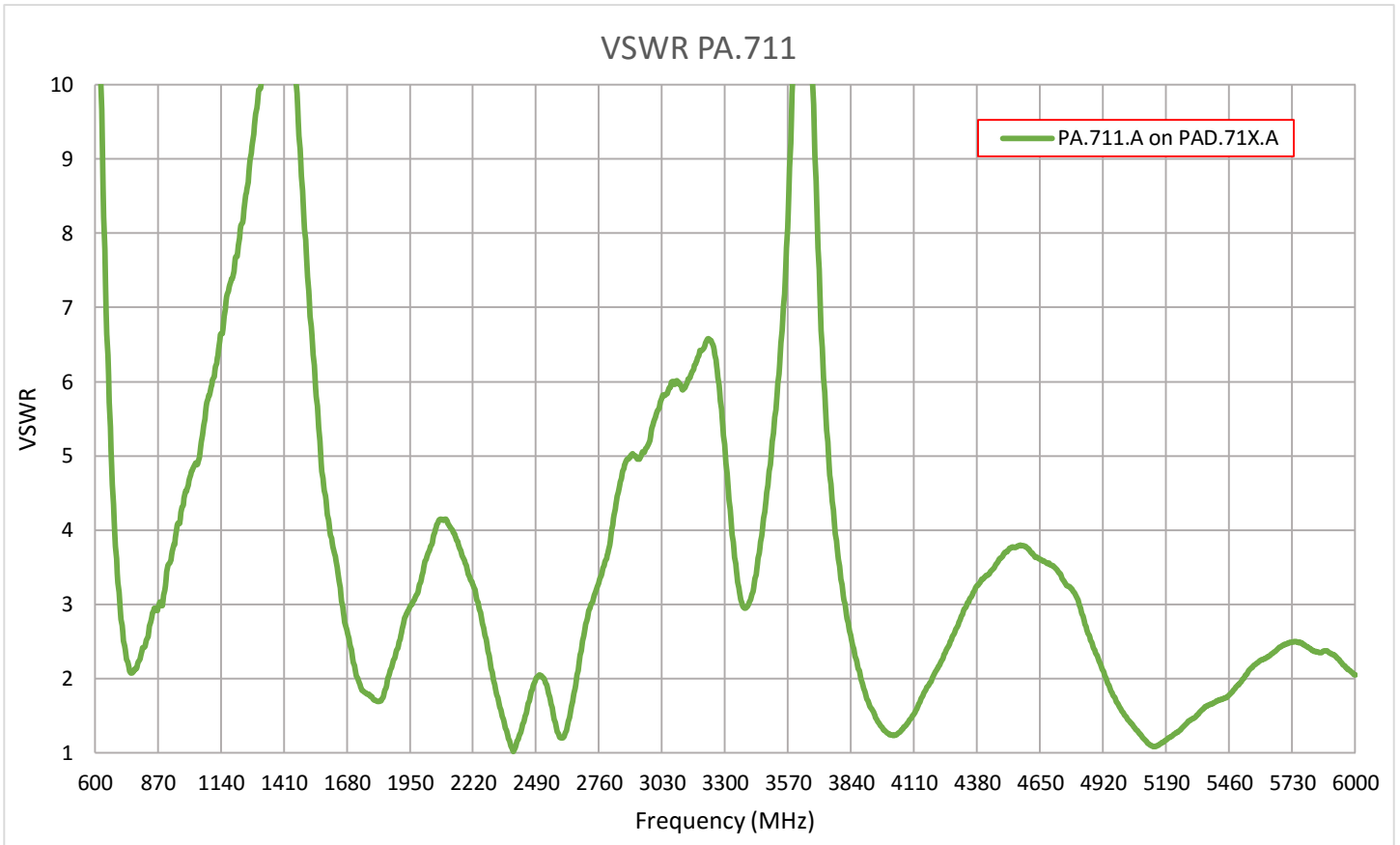

Figure 5. VSWR of the PA.711.A LTE Antenna on MIMO PAD.71X.A

4.3 Isolation

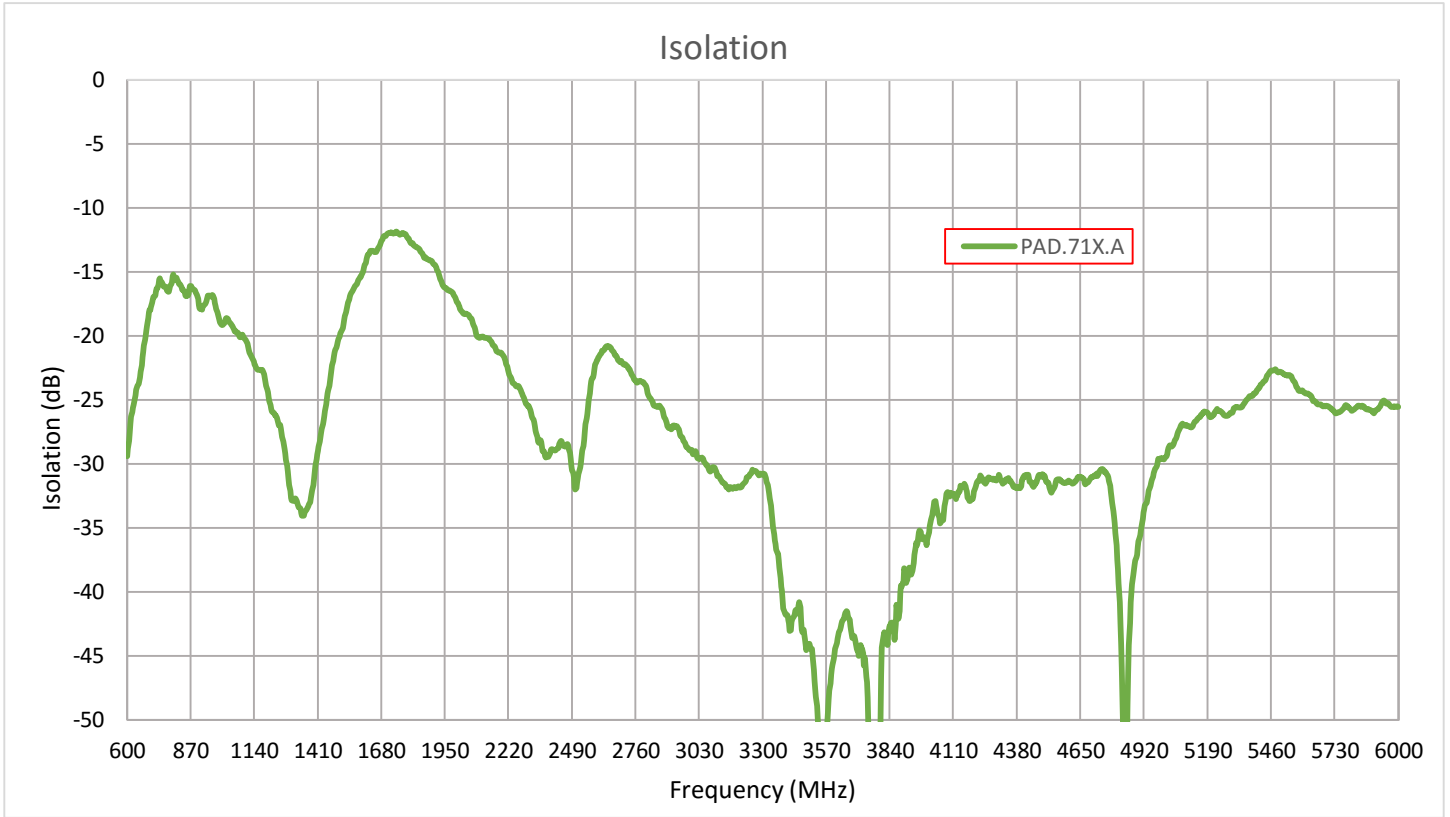

Figure 6. Isolation in between LTE PA.711 and PA.710 antennas on MIMO PAD.71X.A

4.4 Envelope Correlation Coefficient (ECC)

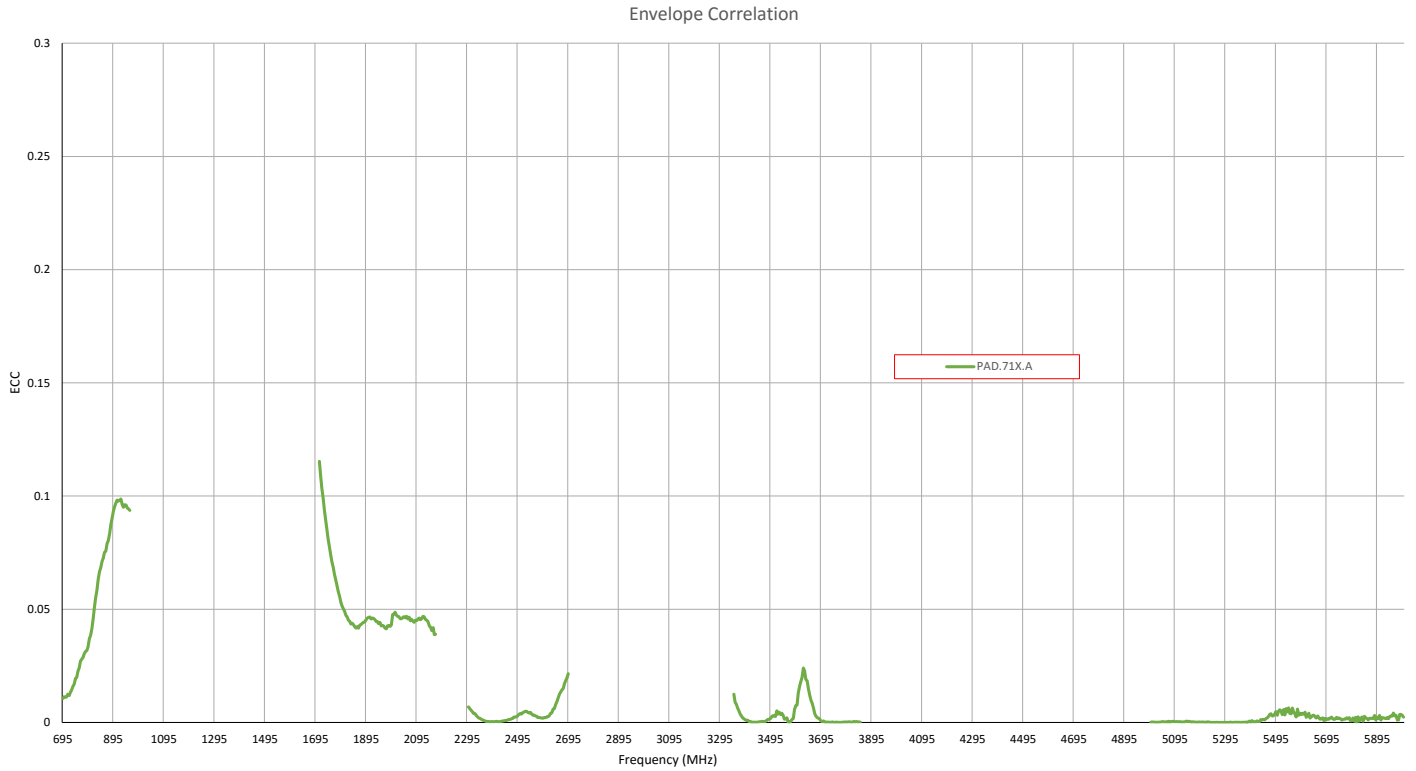

Figure 7. ECC in between LTE PA.711 and PA.710 antennas on MIMO PAD.71X.A

4.5 Efficiency

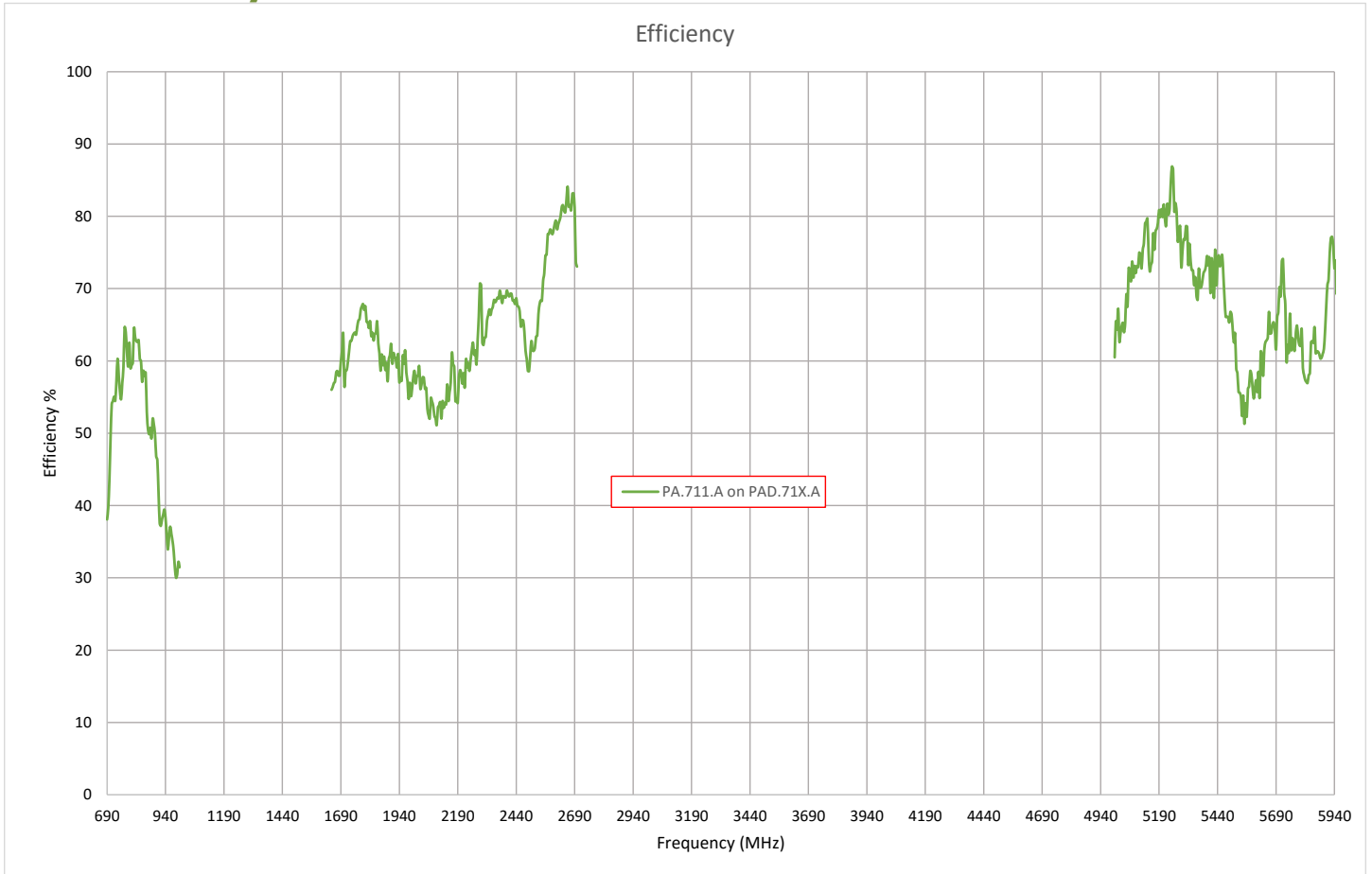

Figure 8. Efficiency of the PA.711.A LTE Antenna on MIMO PAD.71X.A

4.6 Peak Gain

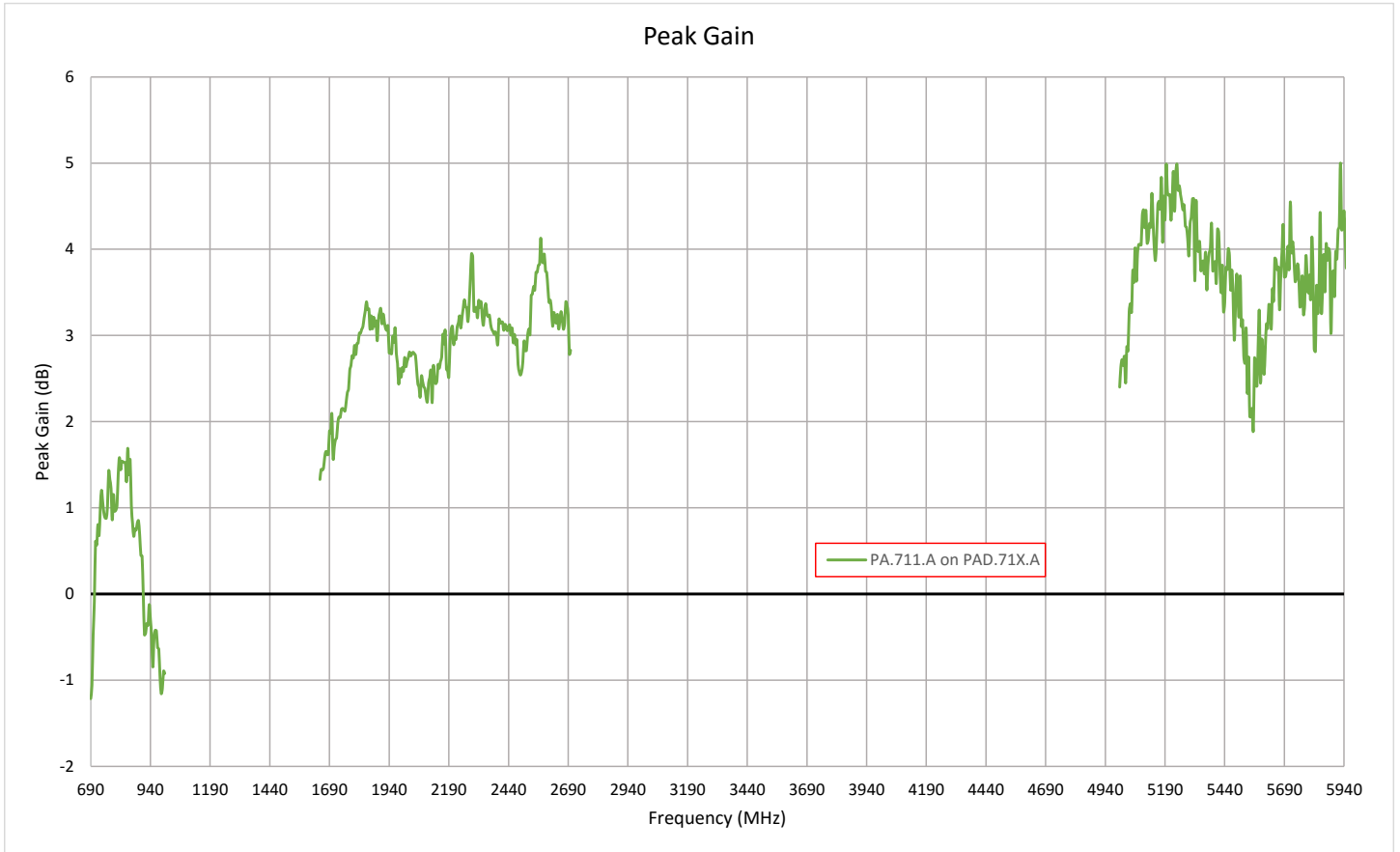

Figure 9. Peak Gain of the PA.711.A LTE Antenna on MIMO PAD.71X.A

4.7 Average Gain

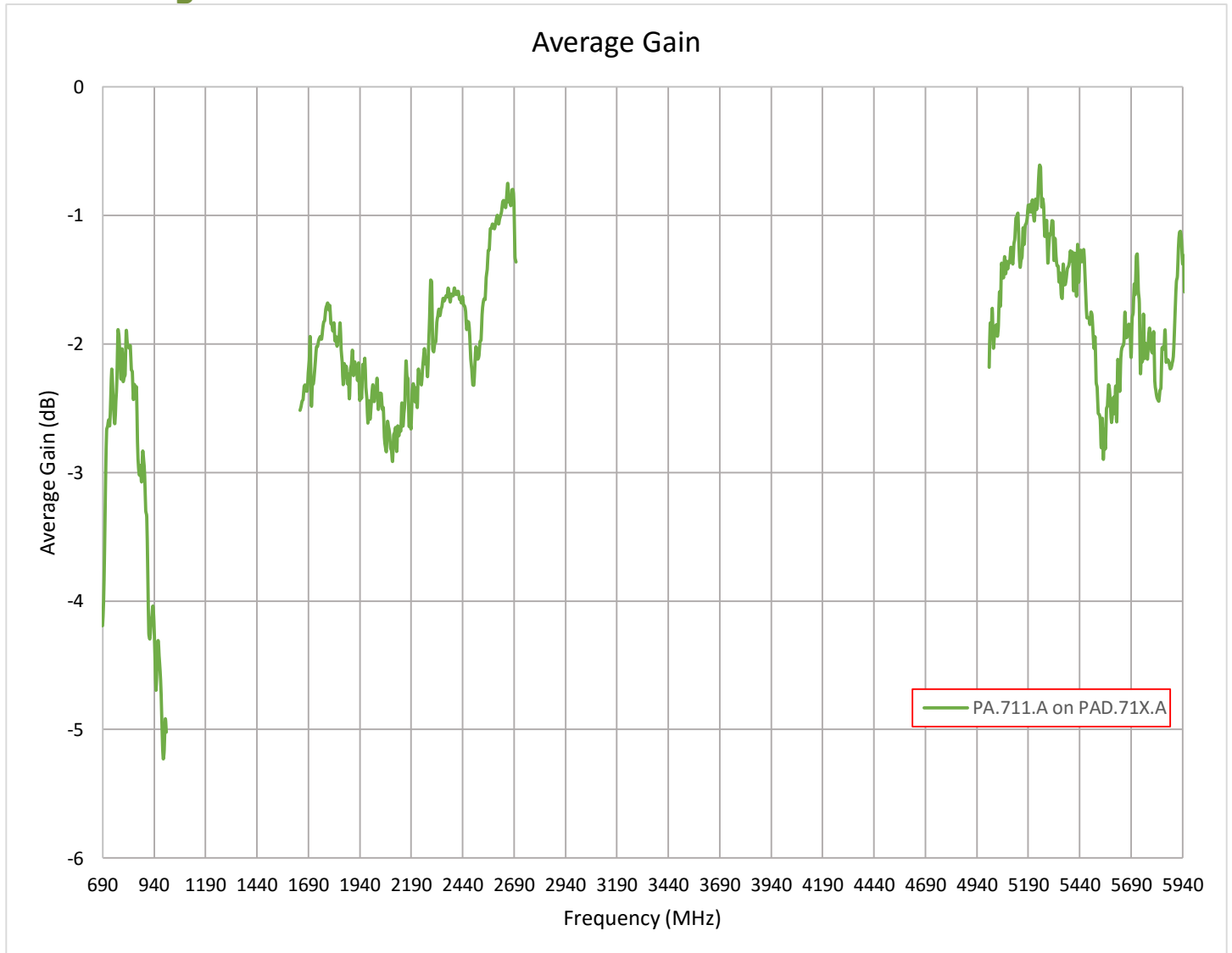

Figure 10. Average Gain of the PA.711.A LTE Antenna on MIMO PAD.71X.A

4.8 3D Radiation Pattern of PA.711.A on PAD.71X.A

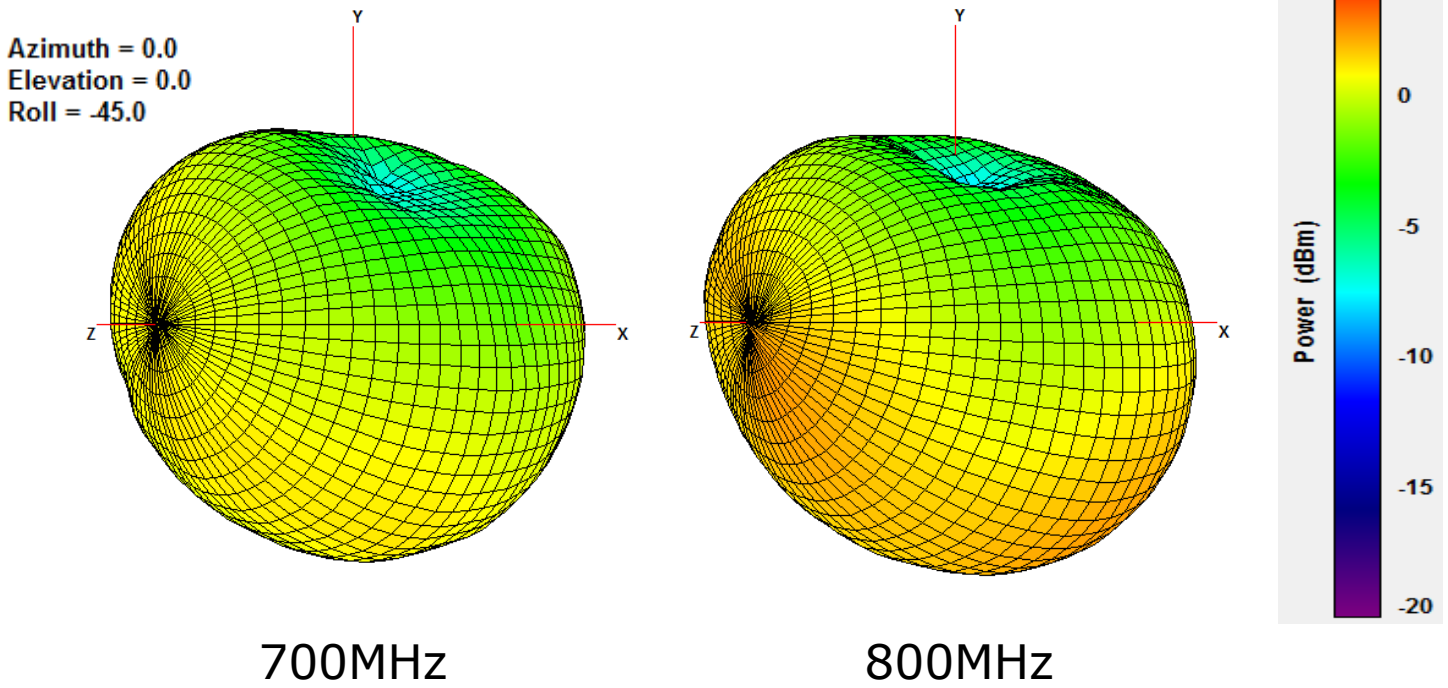

Figure 11. 3D Radiation Pattern at 700 and 800 MHz of the PA.711.A Antenna on MIMO PAD.71X.A

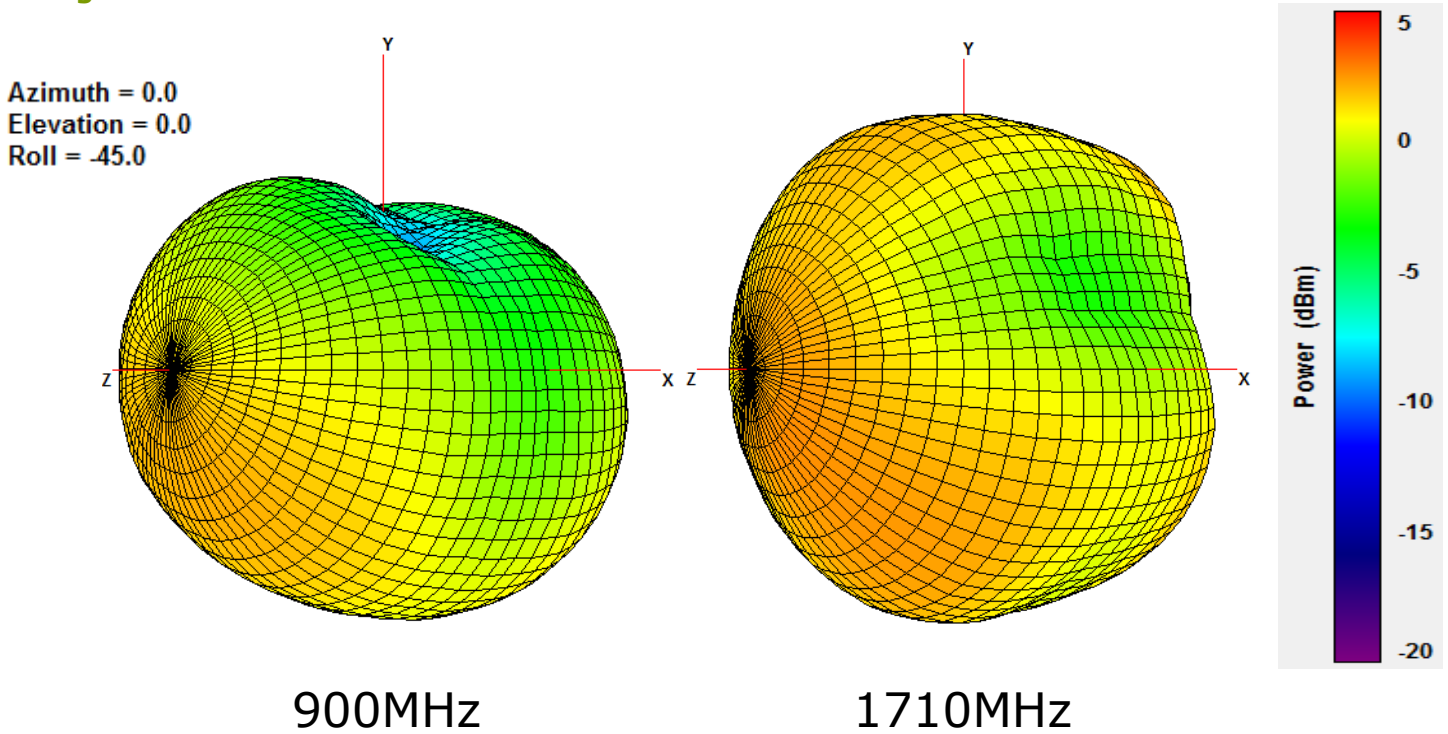
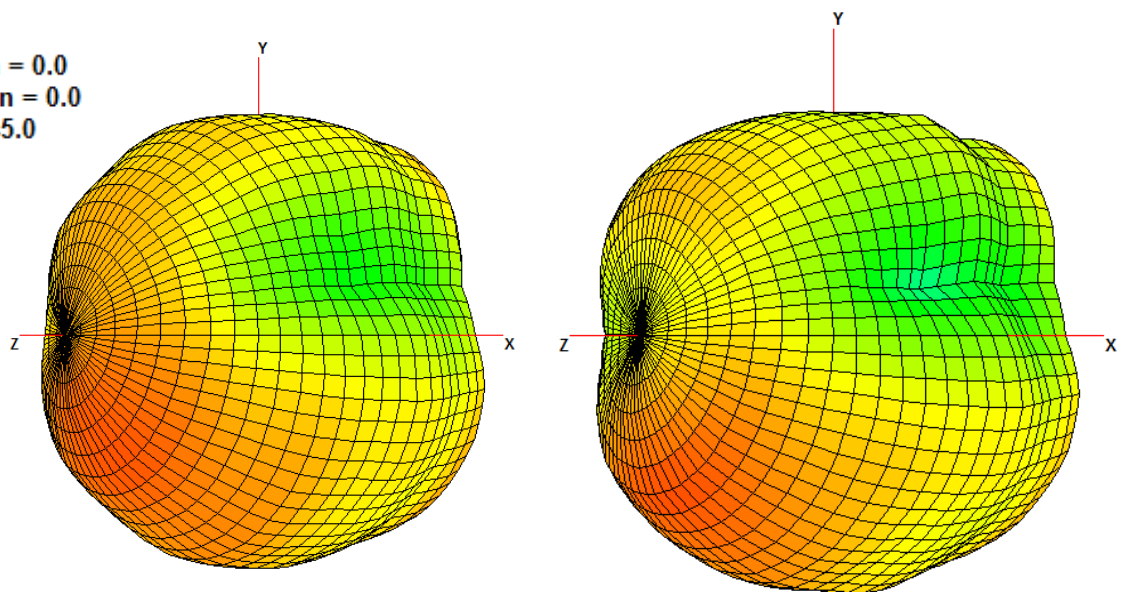

Figure 12. 3D Radiation Pattern at 900 and 1700 MHz of the PA.711.A Antenna on MIMO PAD.71X.A



Azimuth = 0.0
Elevation = 0.0
Roll = -45.0



1805MHz

1910MHz

Figure 13. 3D Radiation Pattern at 1805 and 1910 MHz of the Warrior PA.711.A Antenna on MIMO PAD.71X.A

Azimuth = 0.0
Elevation = 0.0
Roll = -45.0

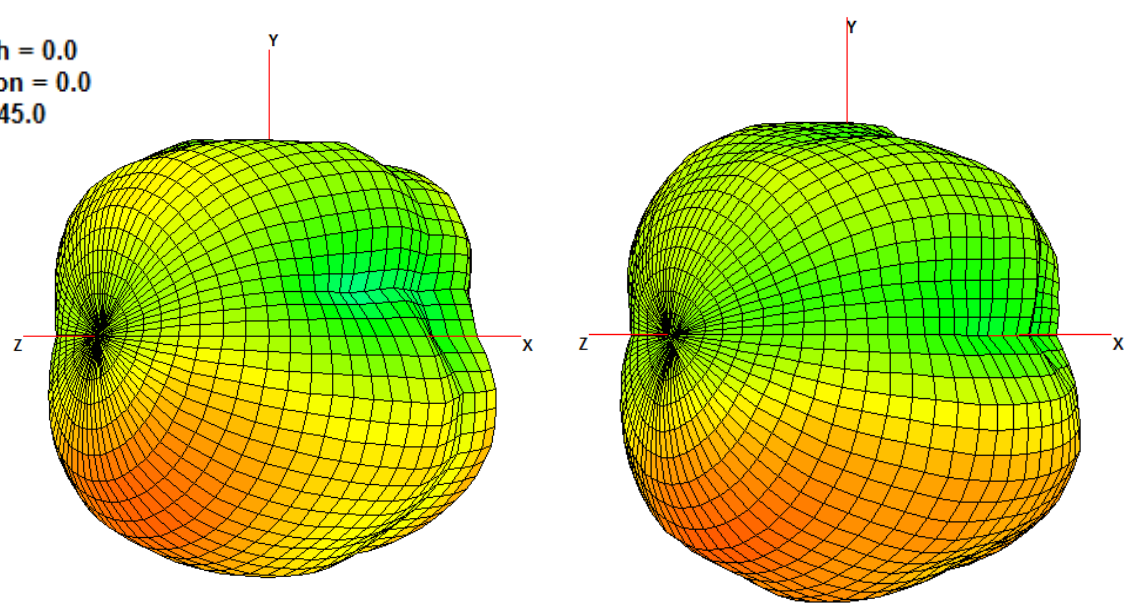

1990MHz

2170MHz

Figure 14. 3D Radiation Pattern at 1990 and 2170 MHz of the Warrior PA.711.A Antenna on MIMO PAD.71X.A



Azimuth = 0.0
Elevation = 0.0
Roll = -45.0

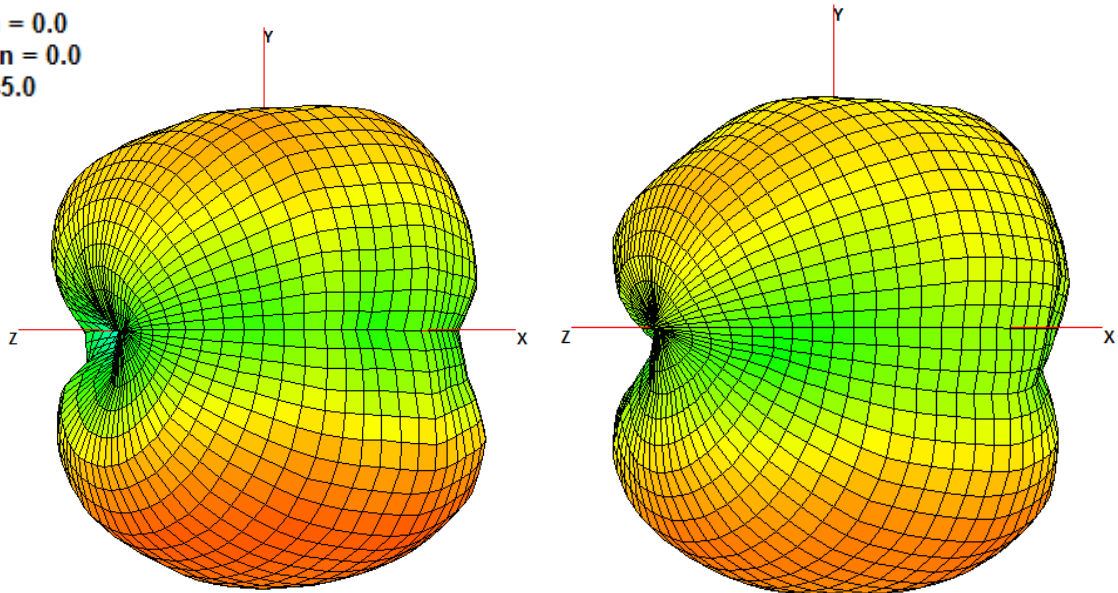

2400MHz

2500MHz

Figure 15. 3D Radiation Pattern at 2500 and 2600 MHz of the Warrior PA.711.A Antenna on MIMO PAD.71X.A

Azimuth = 0.0
Elevation = 0.0
Roll = -45.0

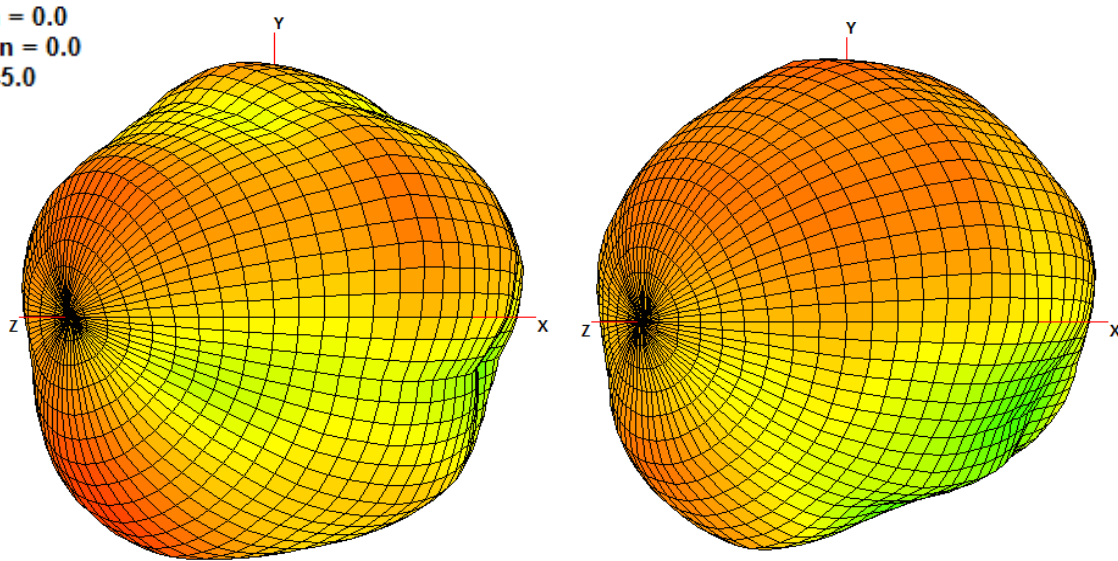

2600MHz

2700MHz

Figure 16. 3D Radiation Pattern at 2600 and 2700 MHz of the Warrior PA.711.A Antenna on MIMO PAD.71X.A



Azimuth = 0.0
Elevation = 0.0
Roll = -45.0

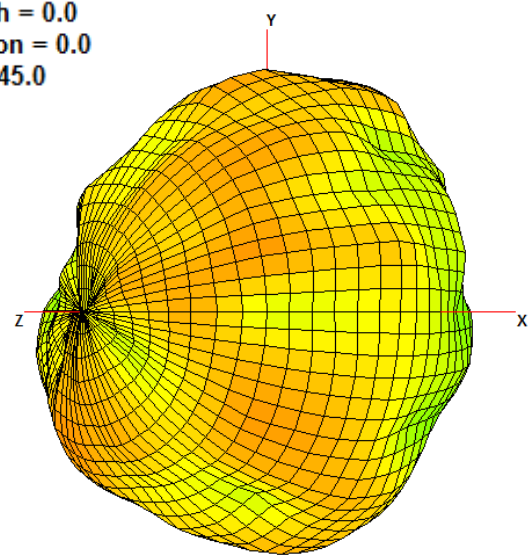

5000MHz

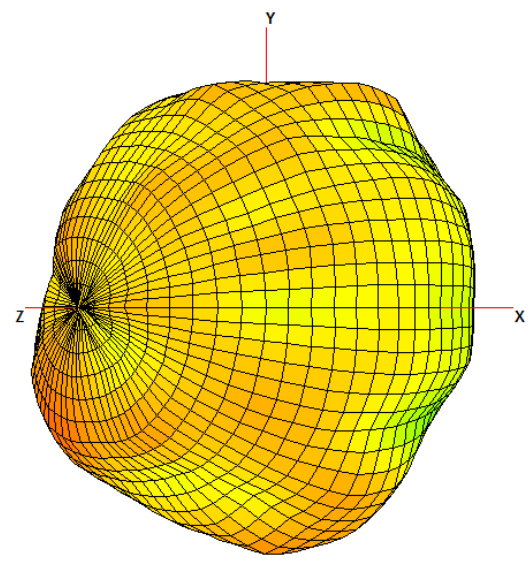

5150MHz

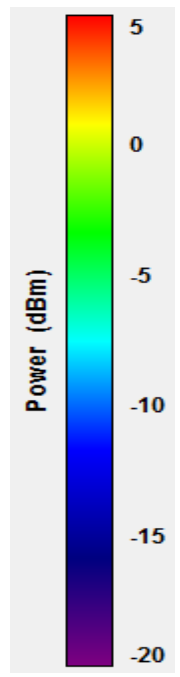
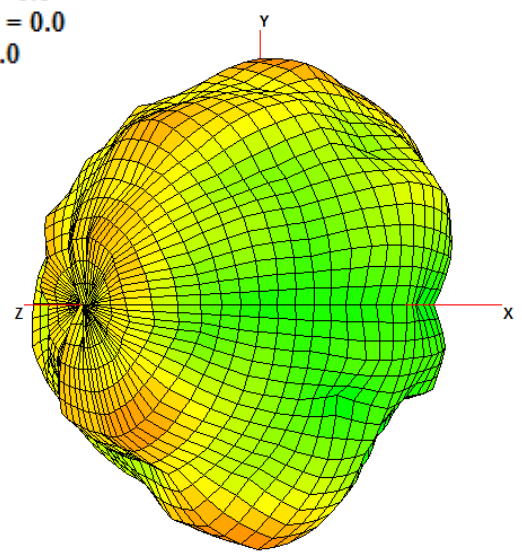
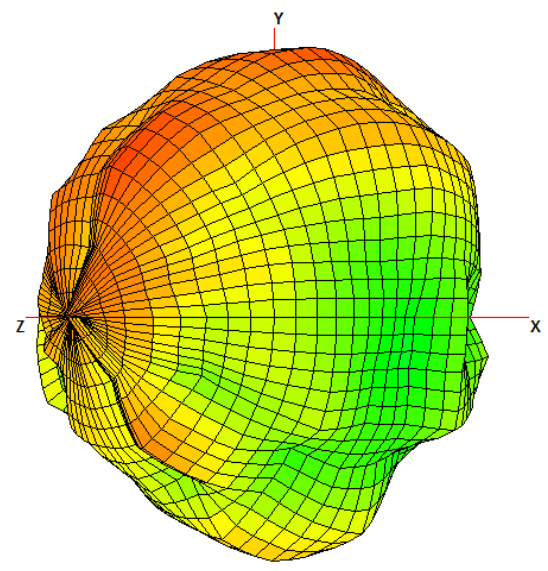

Figure 17. 3D Radiation Pattern at 5000 and 5150 MHz of the Warrior PA.711.A Antenna on MIMO PAD.71X.A

Azimuth = 0.0
Elevation = 0.0
Roll = -45.0



5550MHz



5850MHz

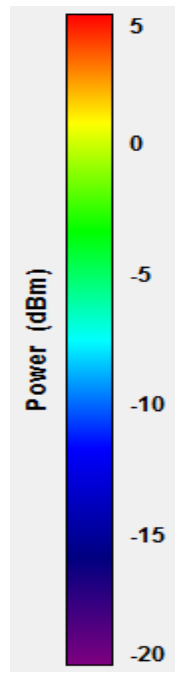
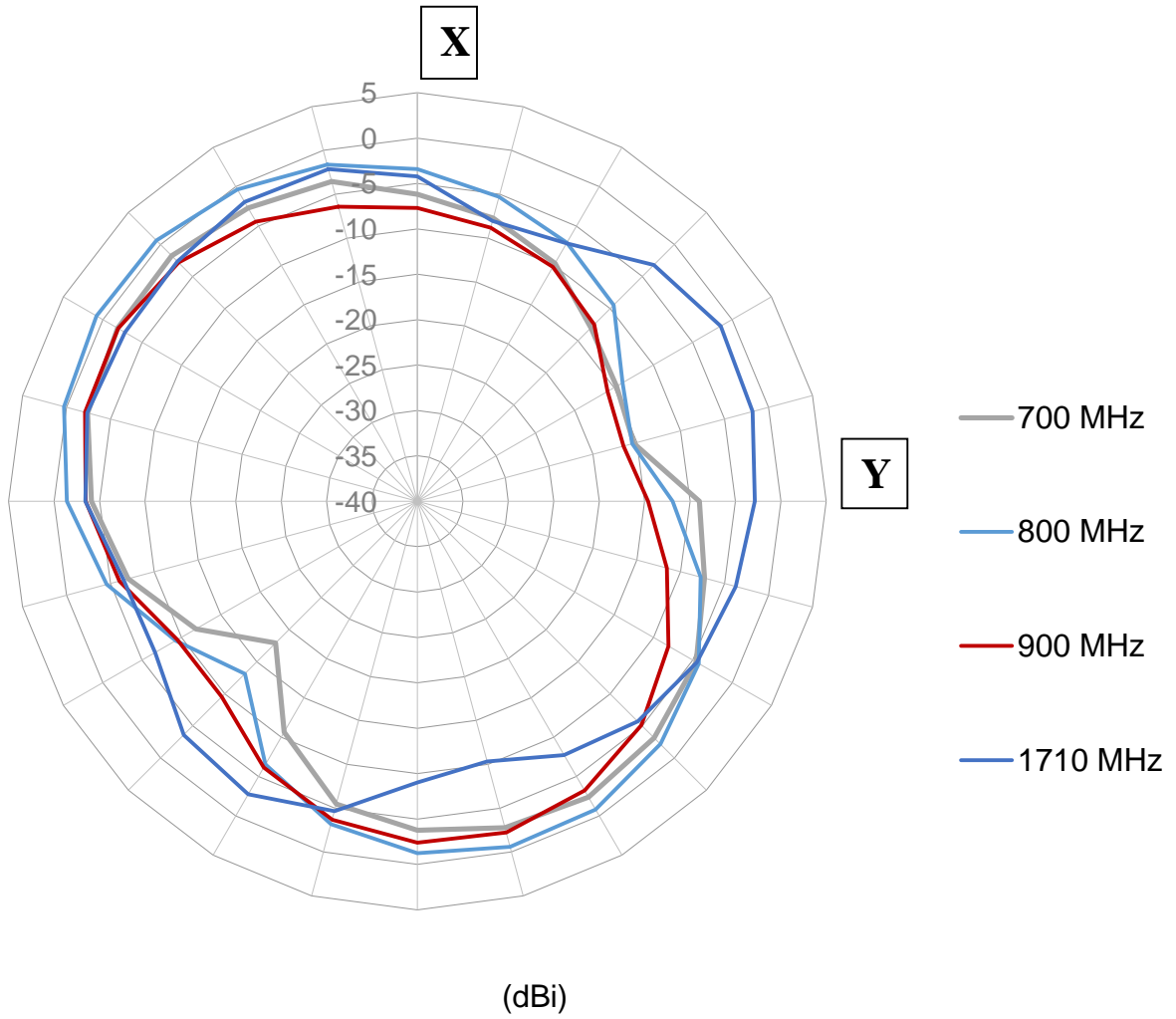

Figure 18. 3D Radiation Pattern at 5550 and 5850 MHz of the Warrior PA.711.A Antenna on MIMO PAD.71X.A

4.9 2D Radiation Pattern of PA.711.A on PAD.71X.A

XY Plane





XZ Plane

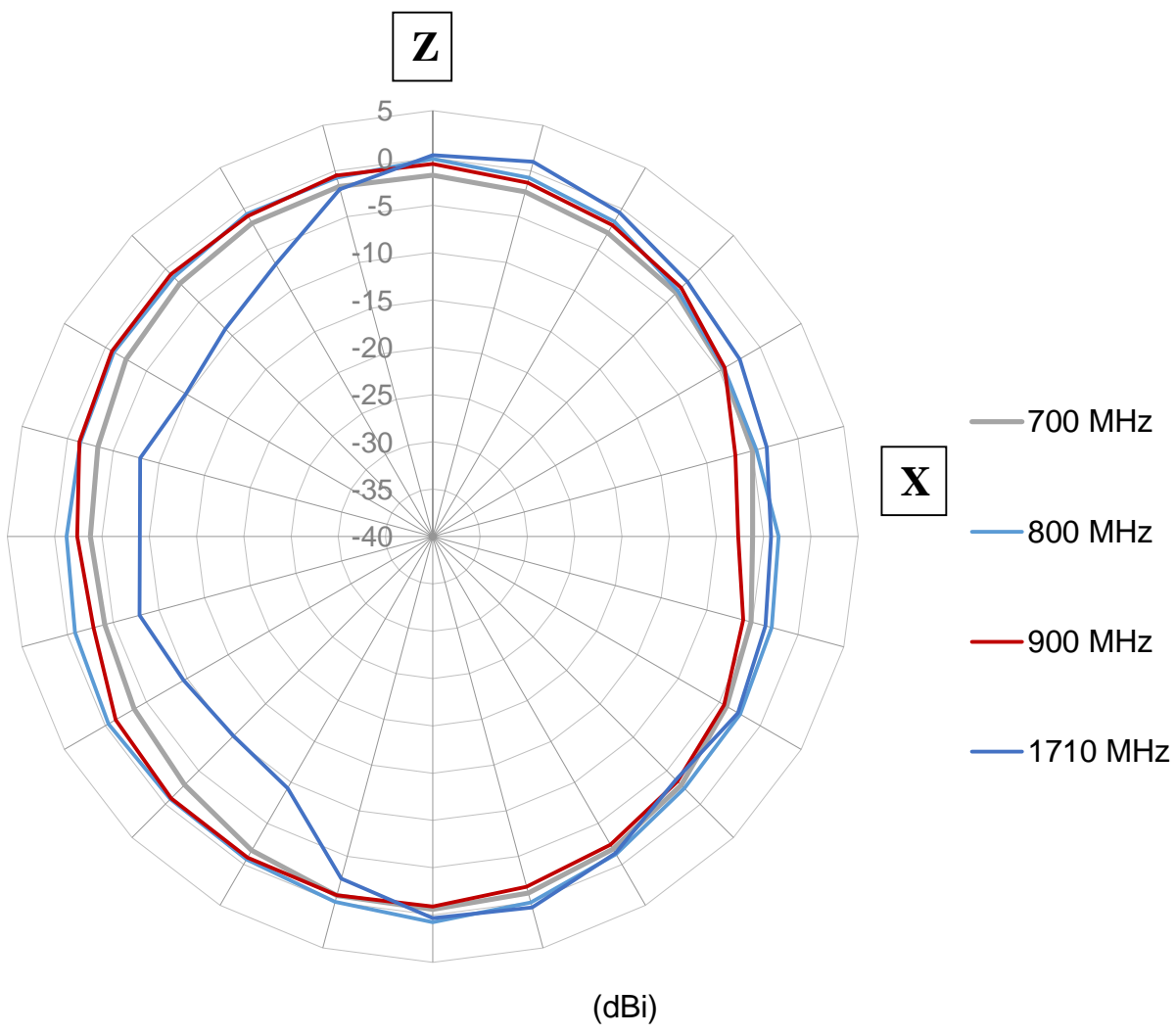



YZ Plane

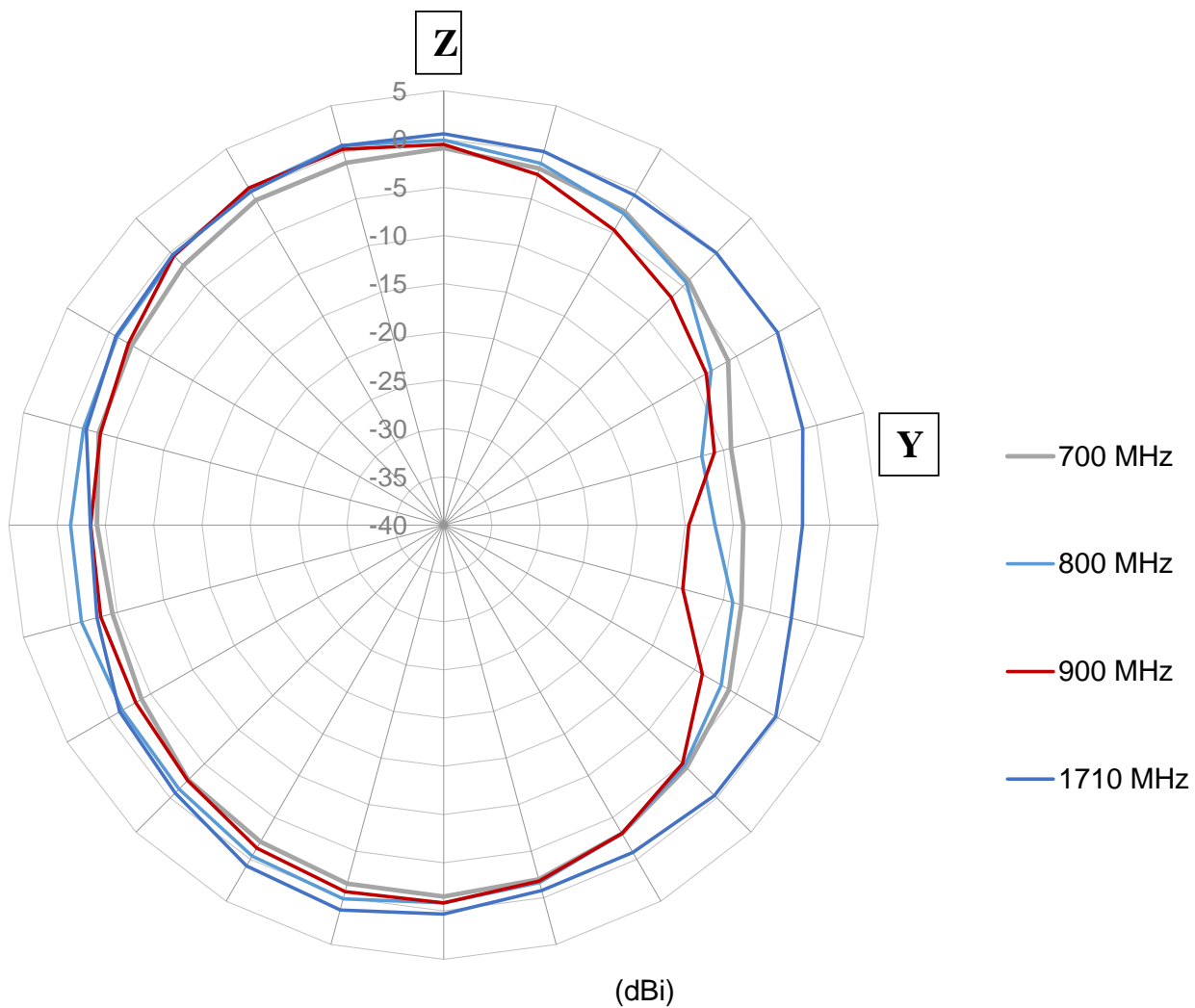



XY Plane

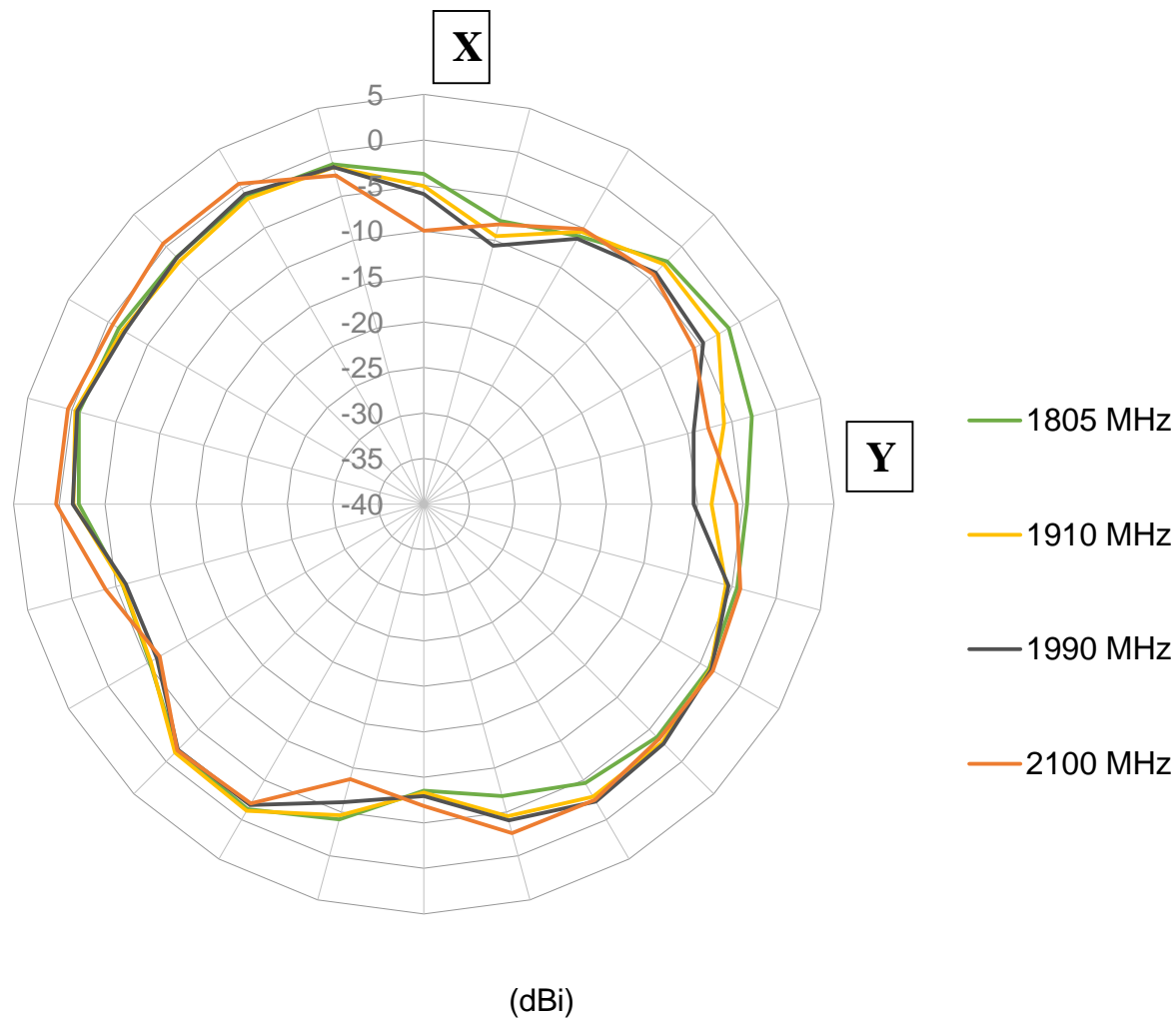

XZ Plane

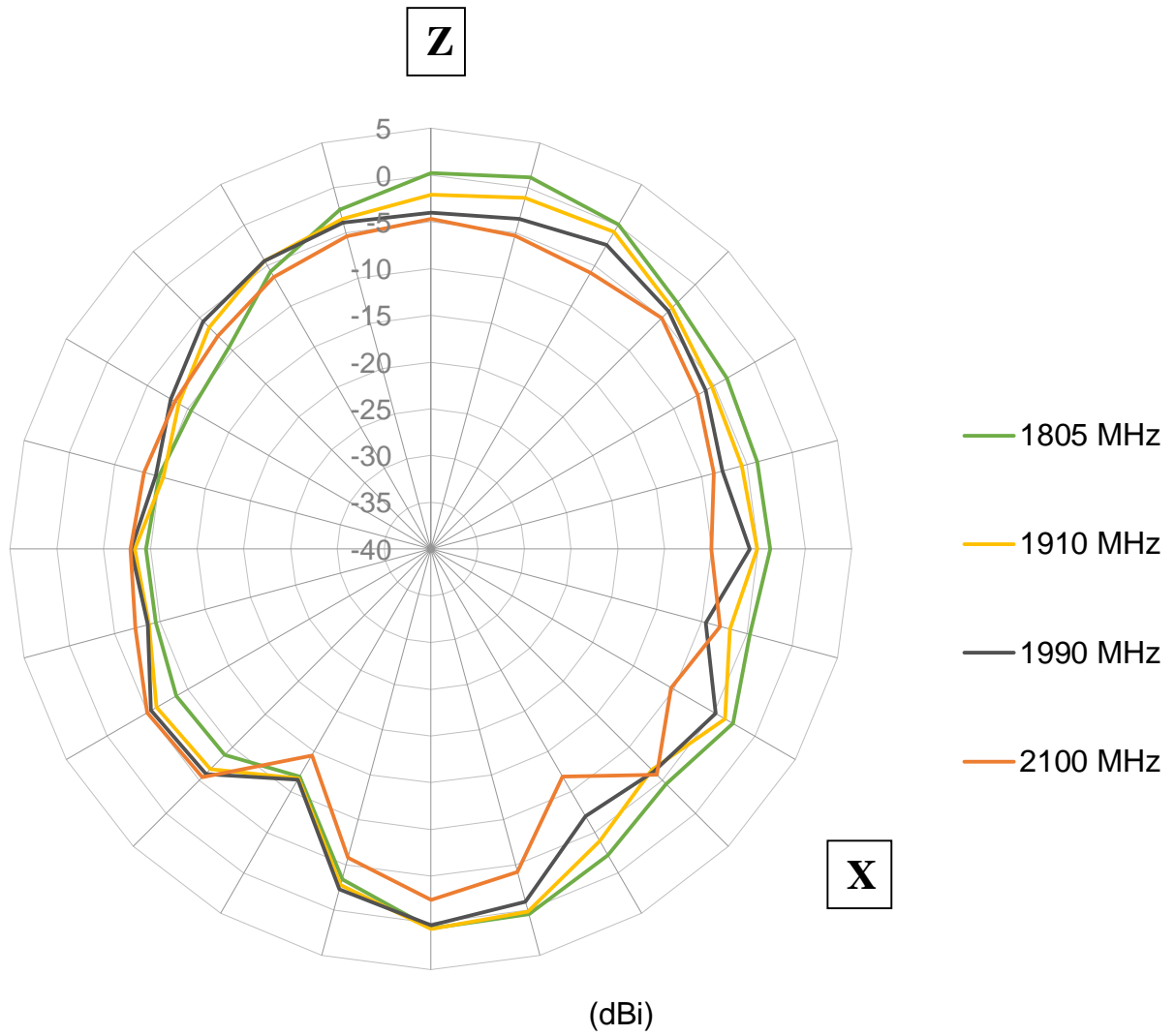

YZ Plane

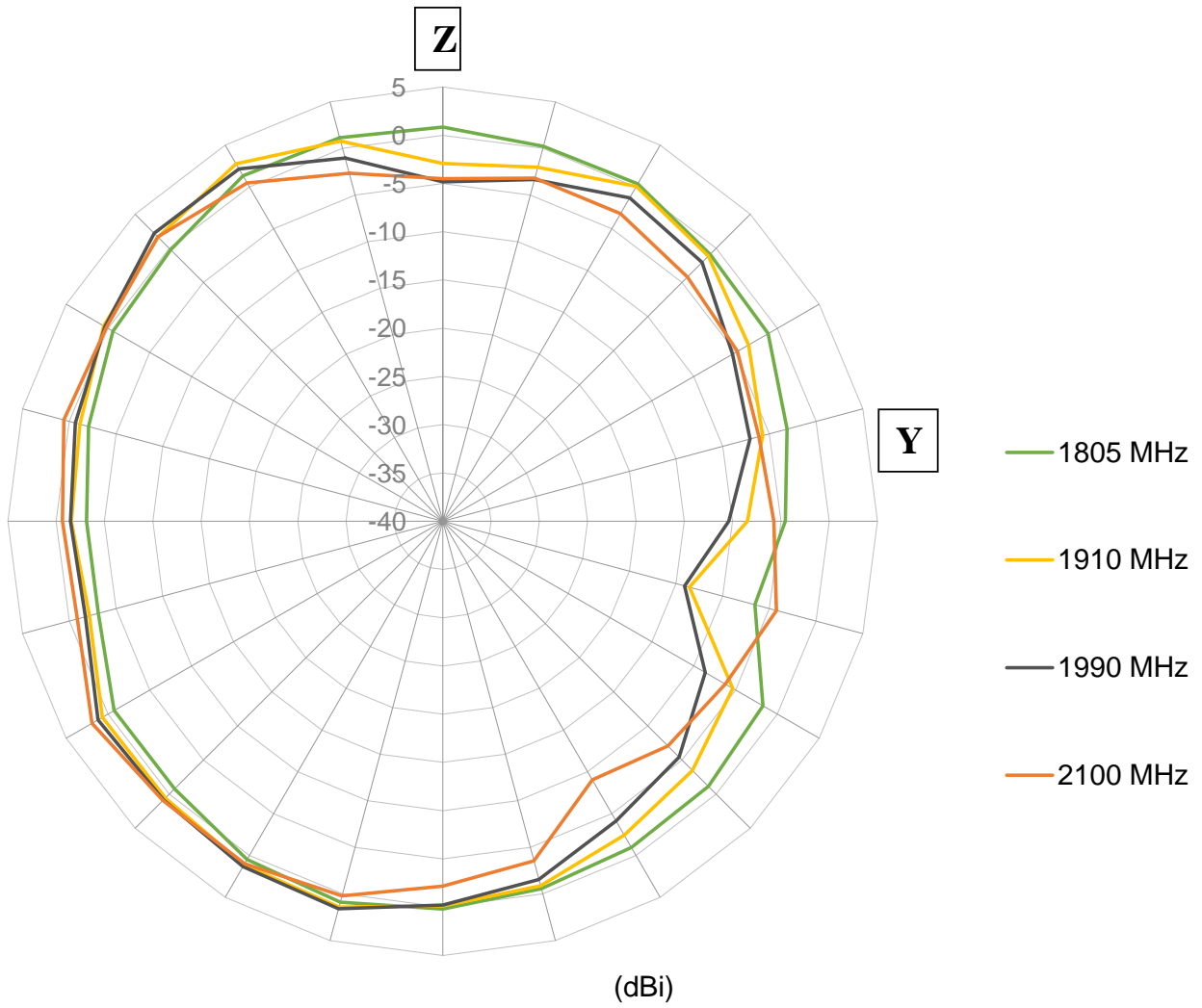



XY Plane

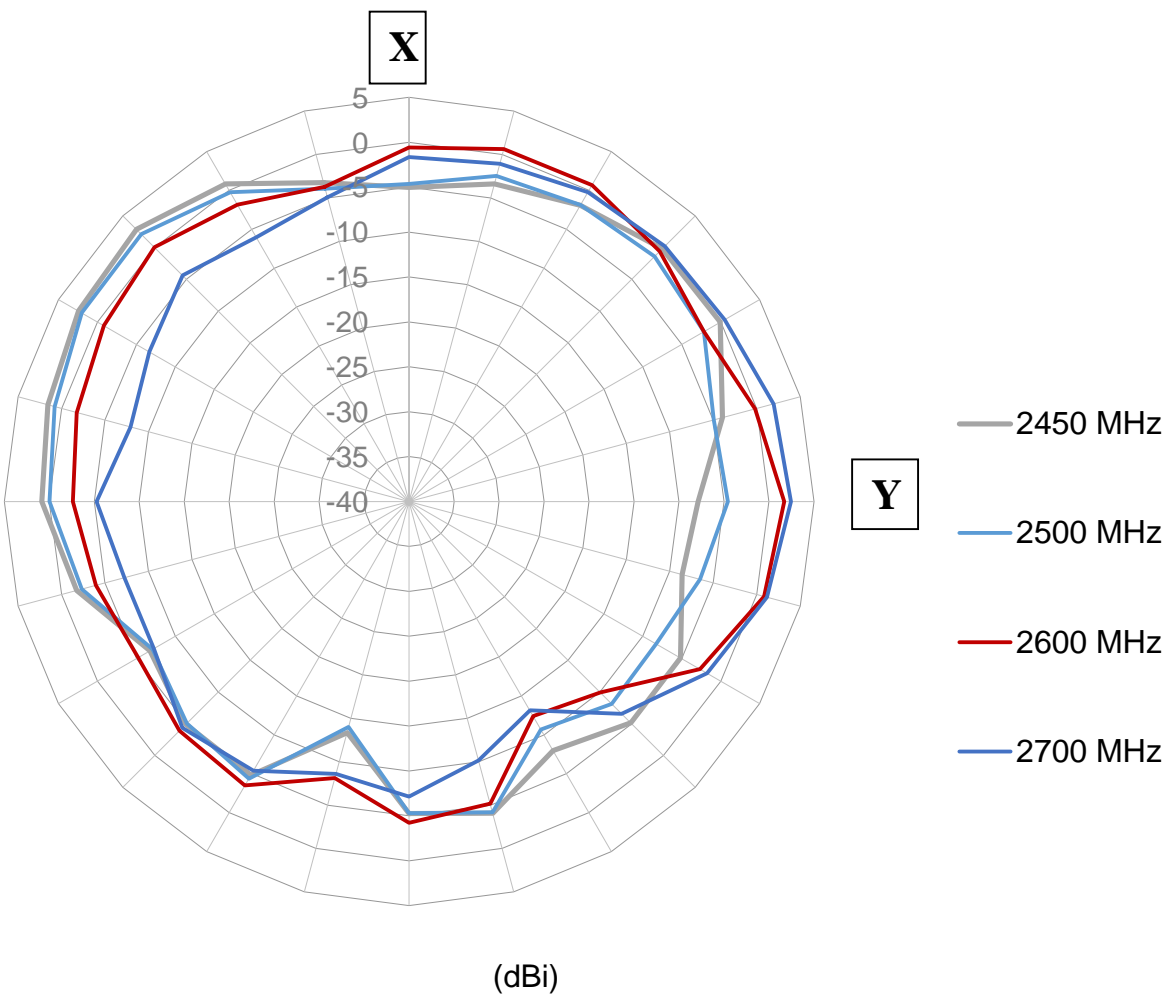



XZ Plane

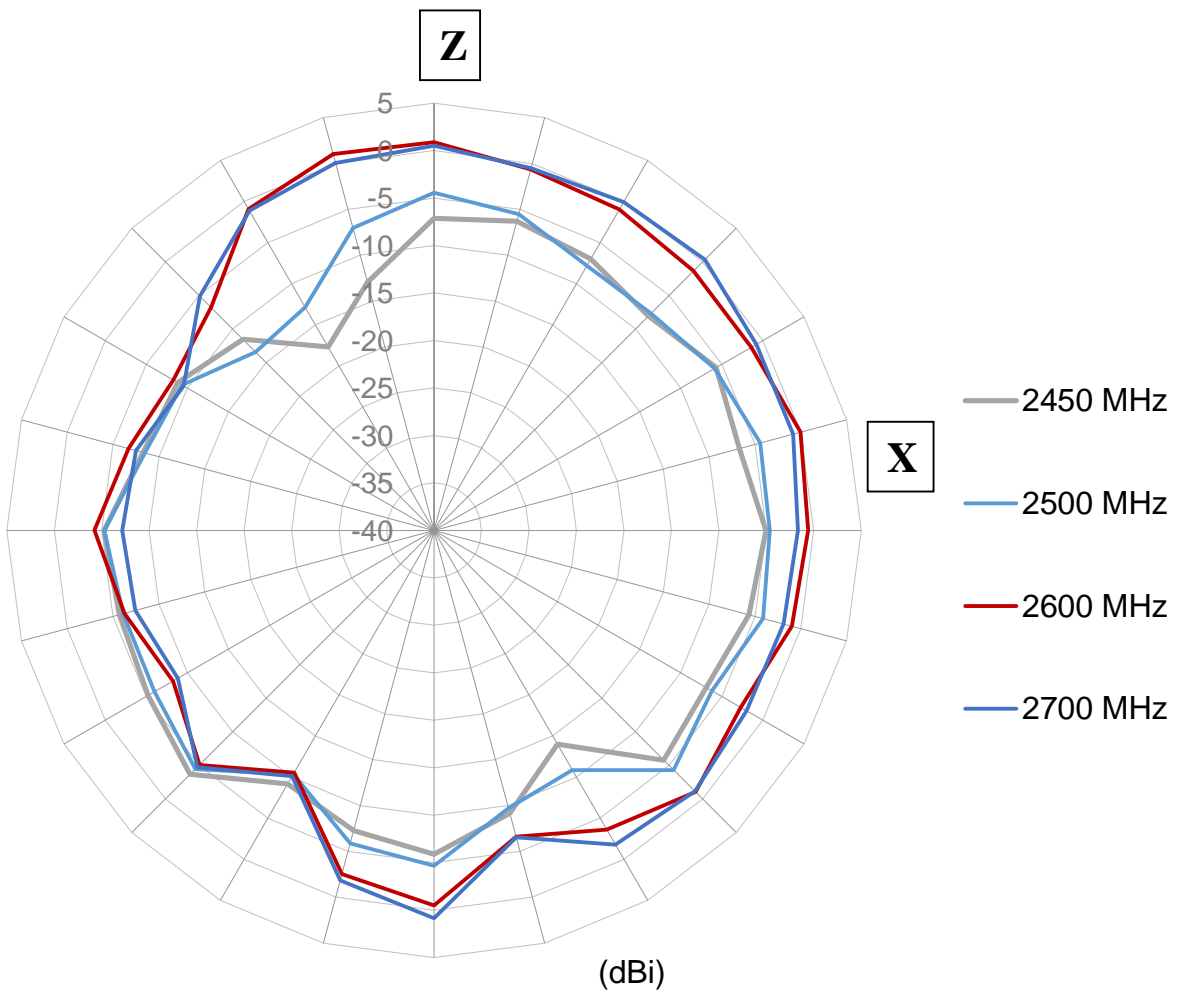



YZ Plane

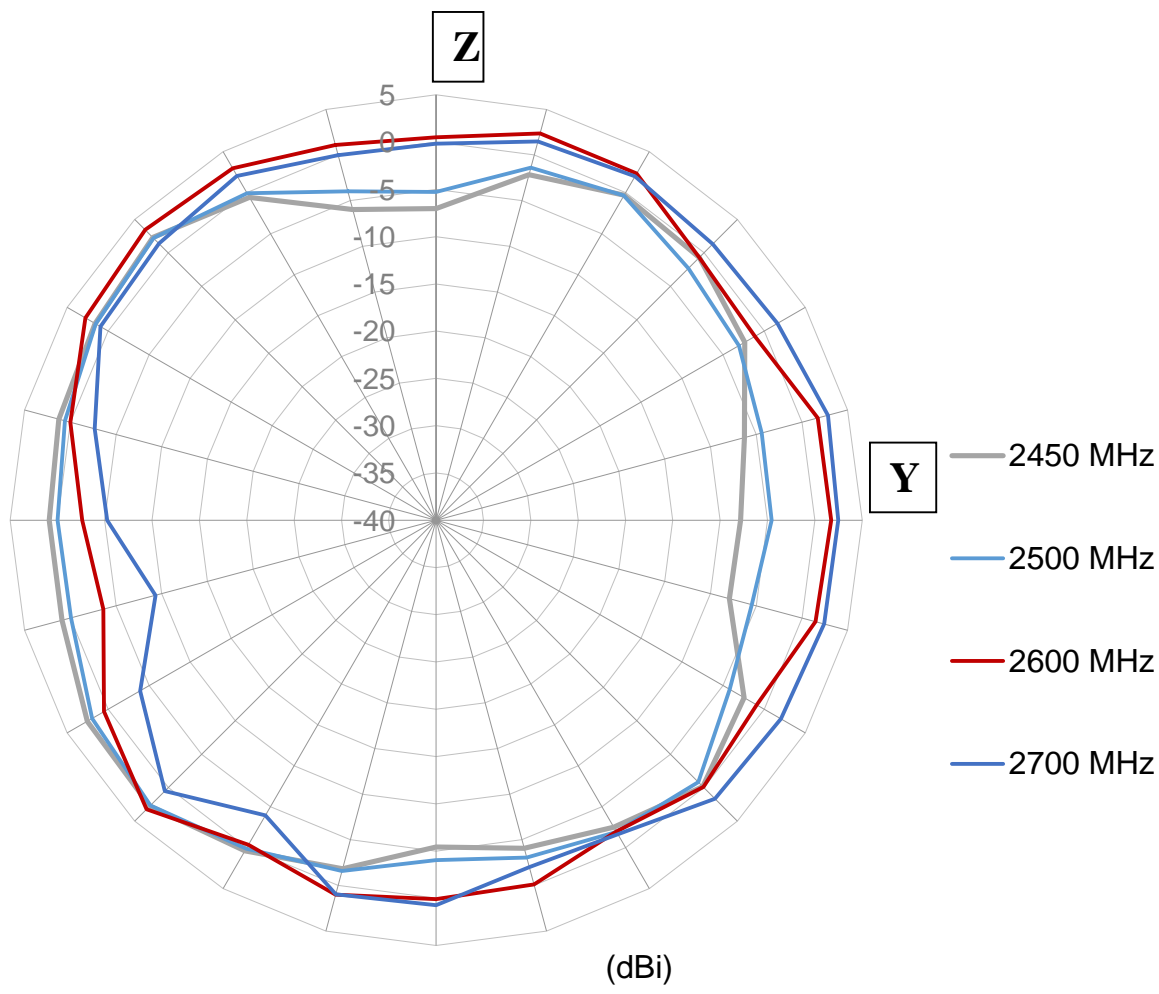



XY Plane

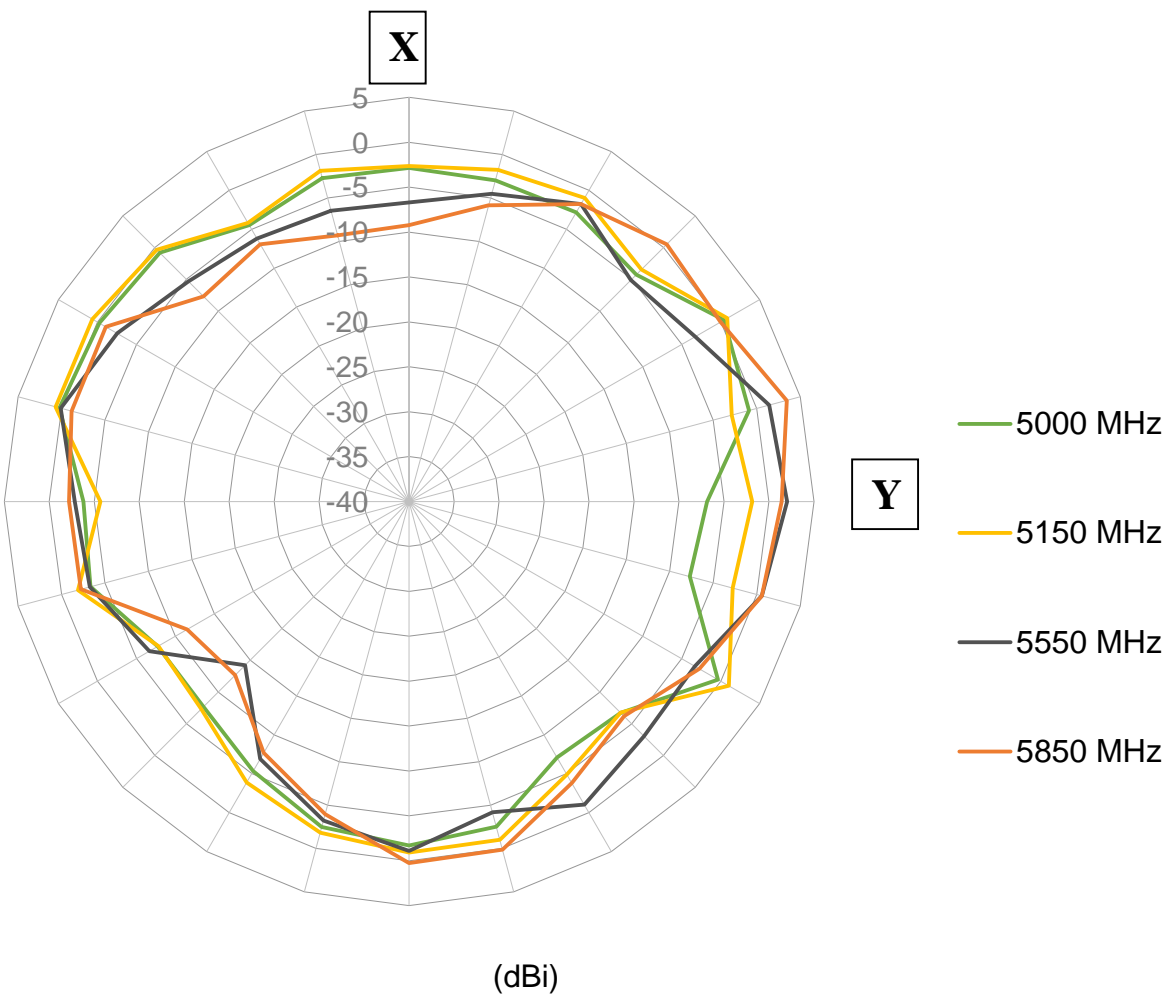

XZ Plane

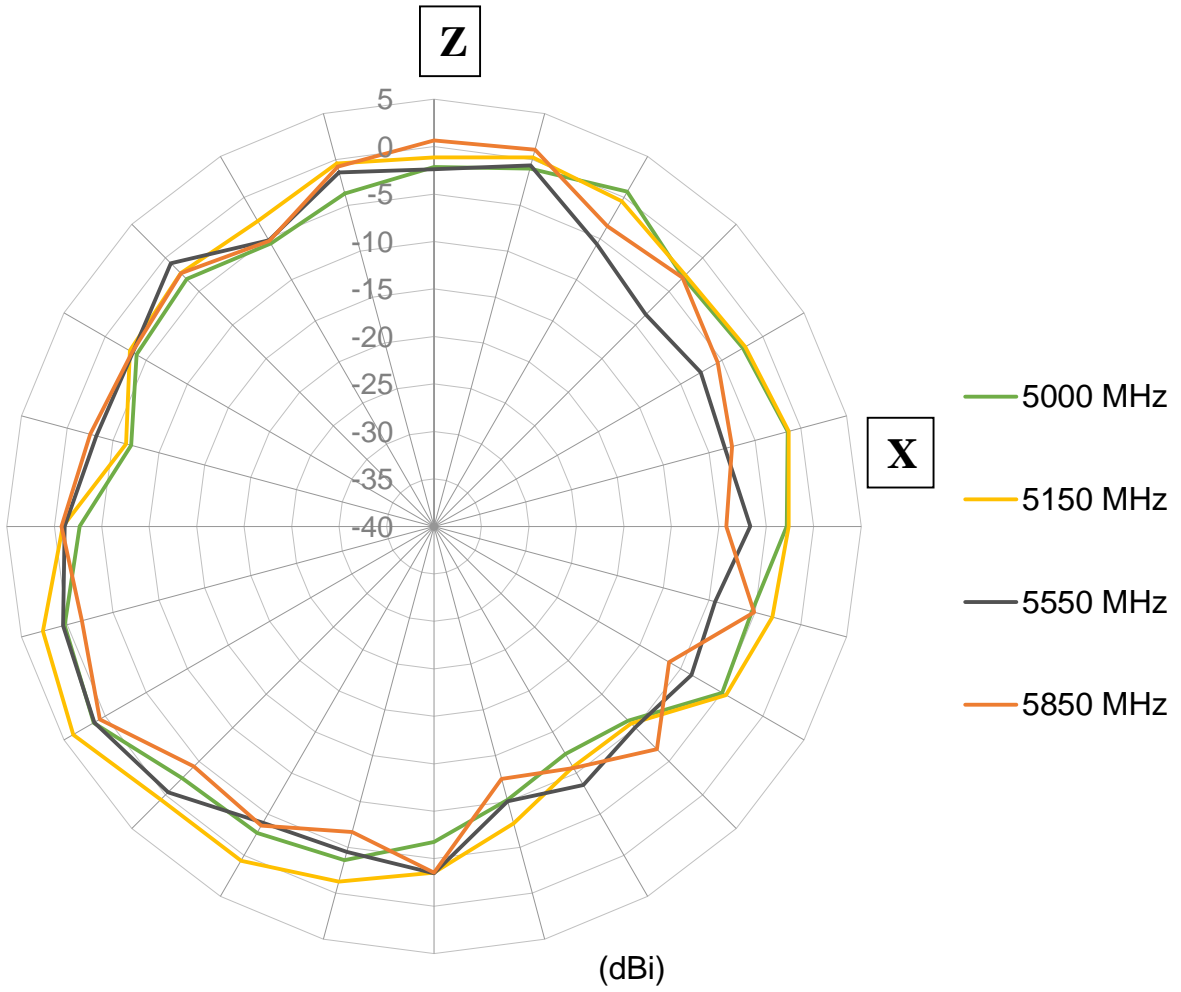



YZ Plane

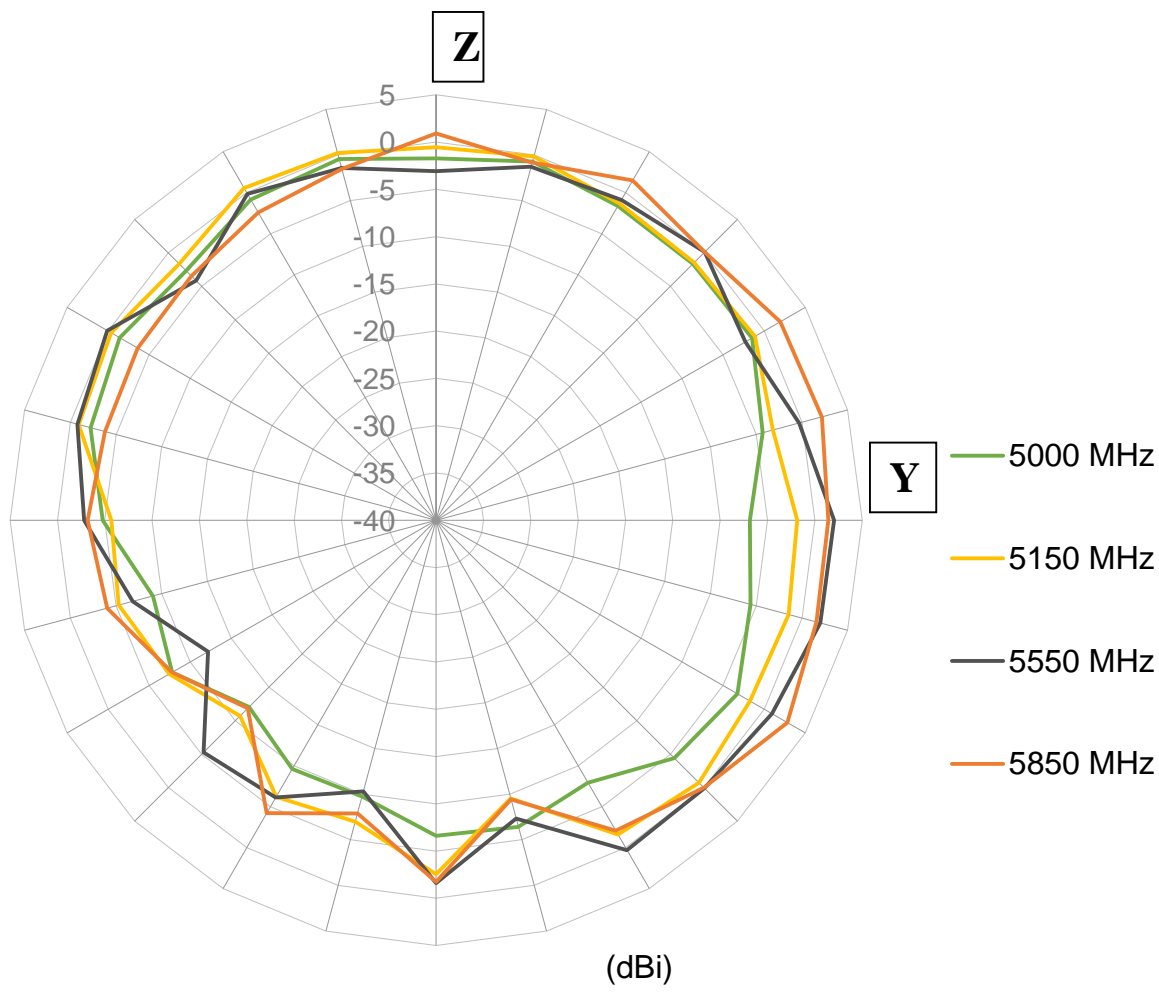
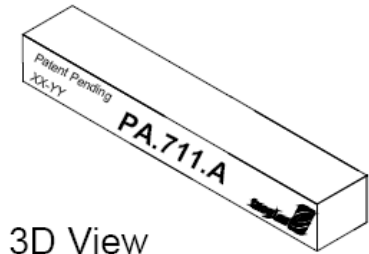
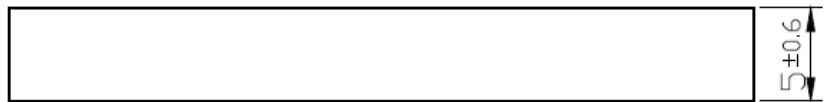

Figure 19. 2D Radiation Pattern of the PA.711.A Antenna on MIMO PAD.71X.A

5 MECHANICAL DRAWING



Bottom



Back

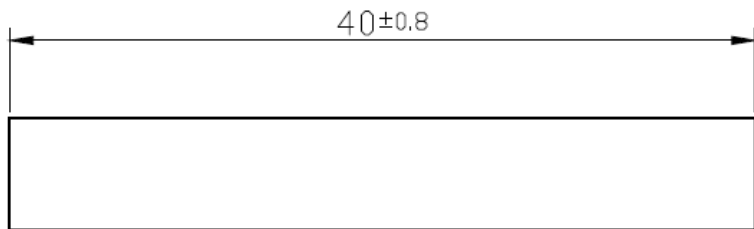

Top

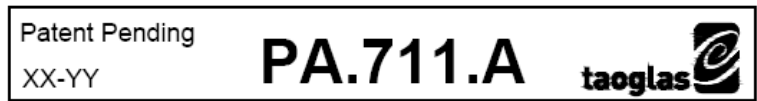

Front

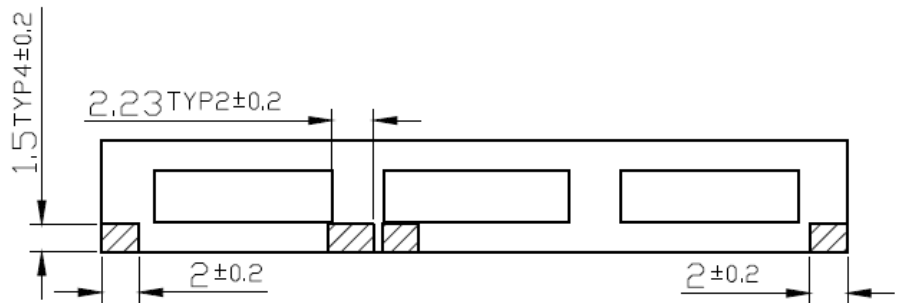

Figure 20. Mechanical Drawing of the PA.711.A Antenna

6 LAYOUT DIMENSION (Standard EVB)

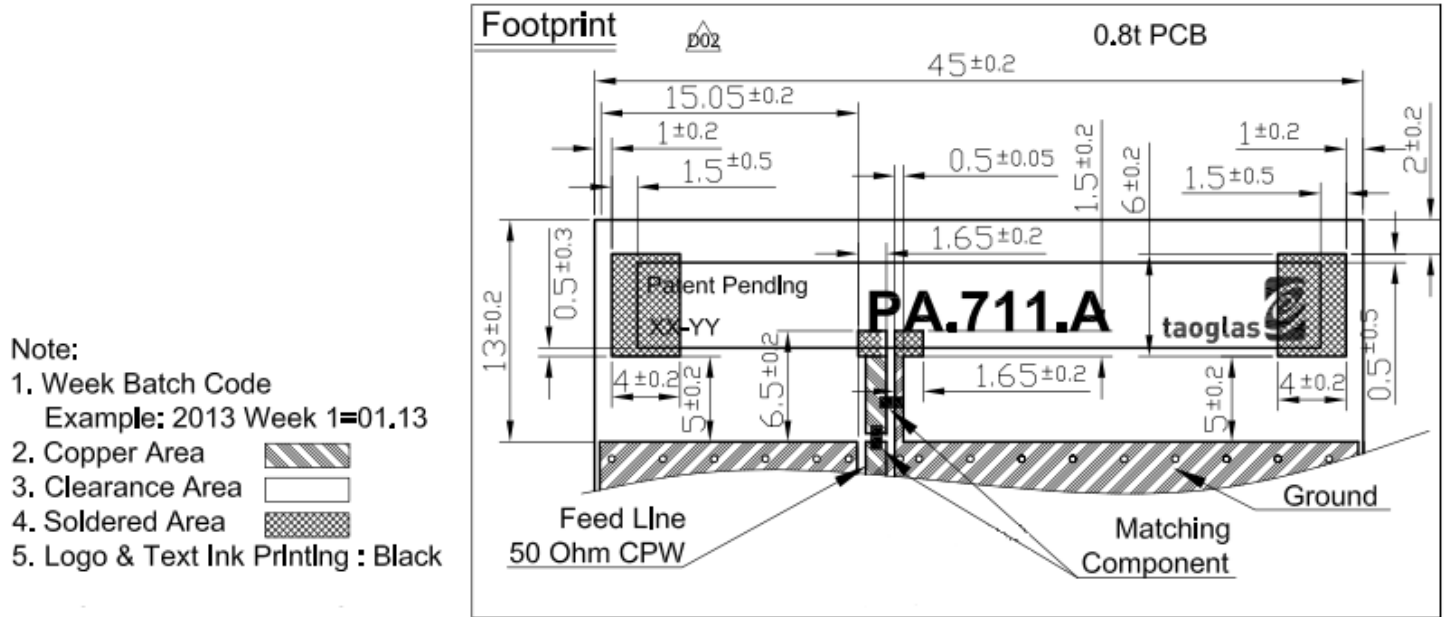
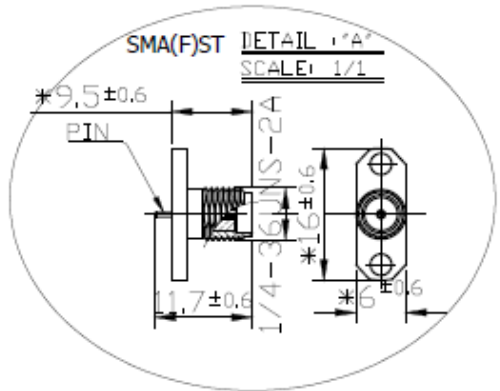
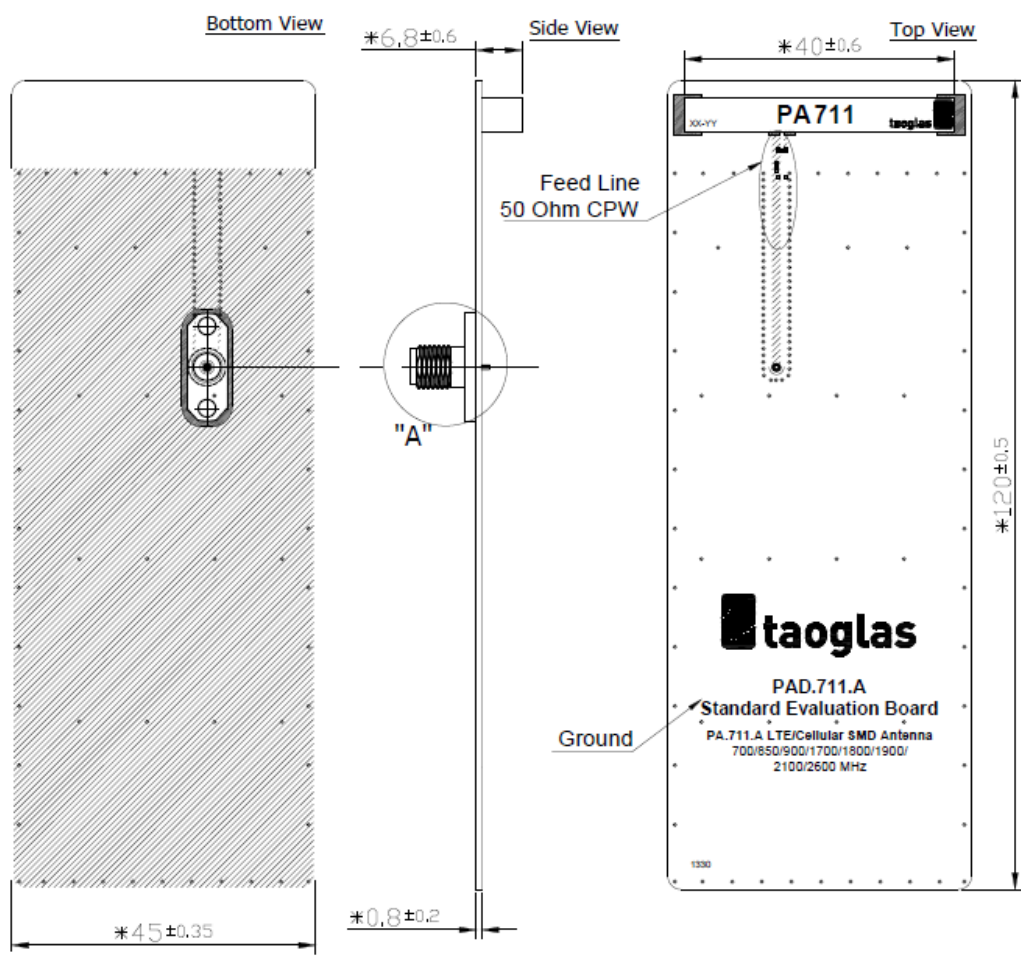

Figure 21. Layout dimensions of the PA.711.A Antenna on EVB

Note: All dimensions are for Taoglas PA.711.A Evaluation Board only – different dimensions may be applied for different board designs.



7 EVB DIMENSIONS



- Note:
1. Week Batch Code
Example: 2010 Week 1=01.10
 2. Slodered area
 3. Copper area
 4. Logo & Text Ink Printing : Black
 5. Ground Clearance Area
 6. " * " Critical Dimensions
 7. Values Of Matching Components May Change According To Different Board Layouts And Device Conditions Contact Taoglas For Support

Figure 22. EVB Dimensions of the PA.711.A Antenna

8 EVB MATCHING CIRCUIT FOR PA.711.A

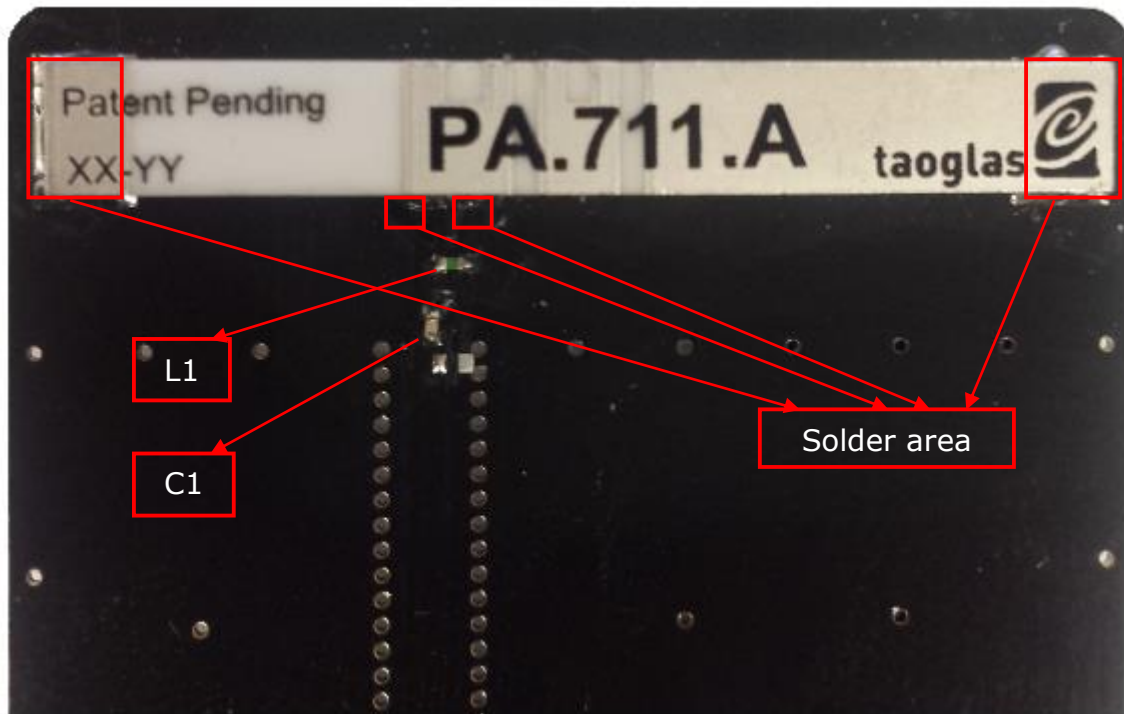
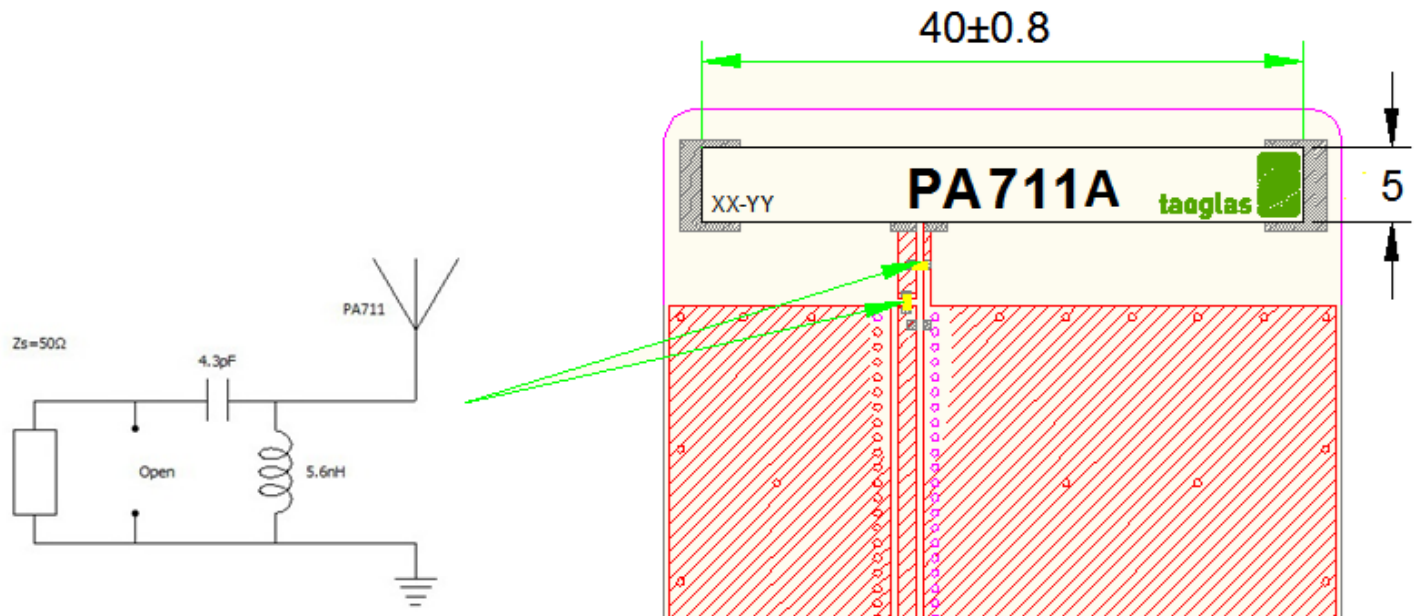

Circuit Symbol	Size	Description
L1	0402	5.6nH inductor (LQG15HS5N6S02D)
C1	0402	4.3pF Capacitor (GRM1555C1H4R3CA01D)

Figure 23. Recommended Matching Circuit

An inductor in parallel with the PA.711.A is required for the antenna to have the optimal performance on the evaluation board. The inductor is located outside of the ground plane in the space specified in the drawings (L1 in figure 23).

The recommended matching component (L1) is a 5.6nH inductor (for standard PA.711.A evaluation board). The inductor is strictly required in the antenna integration (this lumped element is considered as part of the antenna). It is not possible to determine if further improvement in matching is necessary for other PCB integrations, therefore we recommend including extra footprints for a “pi” network in between the GSM module and the edge of the ground plane in your design. The starting point will be putting a 4.3 pF capacitor in series in the “pi” network (S1) and the required 5.6nH outside of the ground plane (L1). With these spaces we have 3 options for matching topologies as in the next figures:

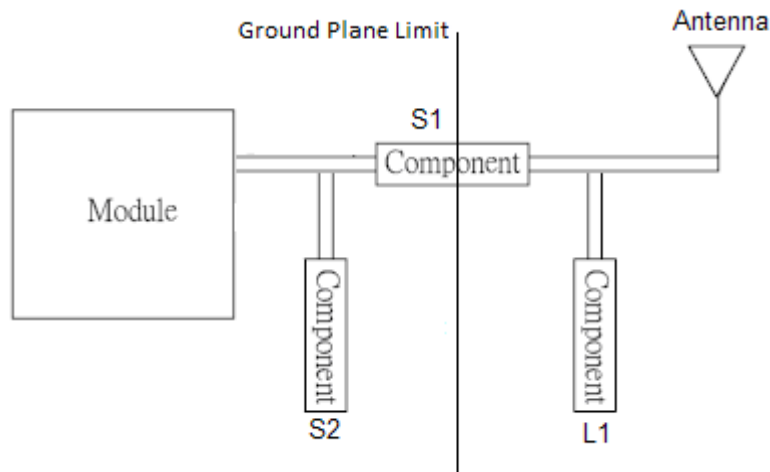

Figure 24. “Pi” matching network

Further investigation could be done to determine if more components are necessary in the “pi” network, but cannot be determined until the device is built and the antenna is integrated.

9 PACKAGING

Blister tape to IEC 286-3, Polyester
 Pieces / Tape = 450

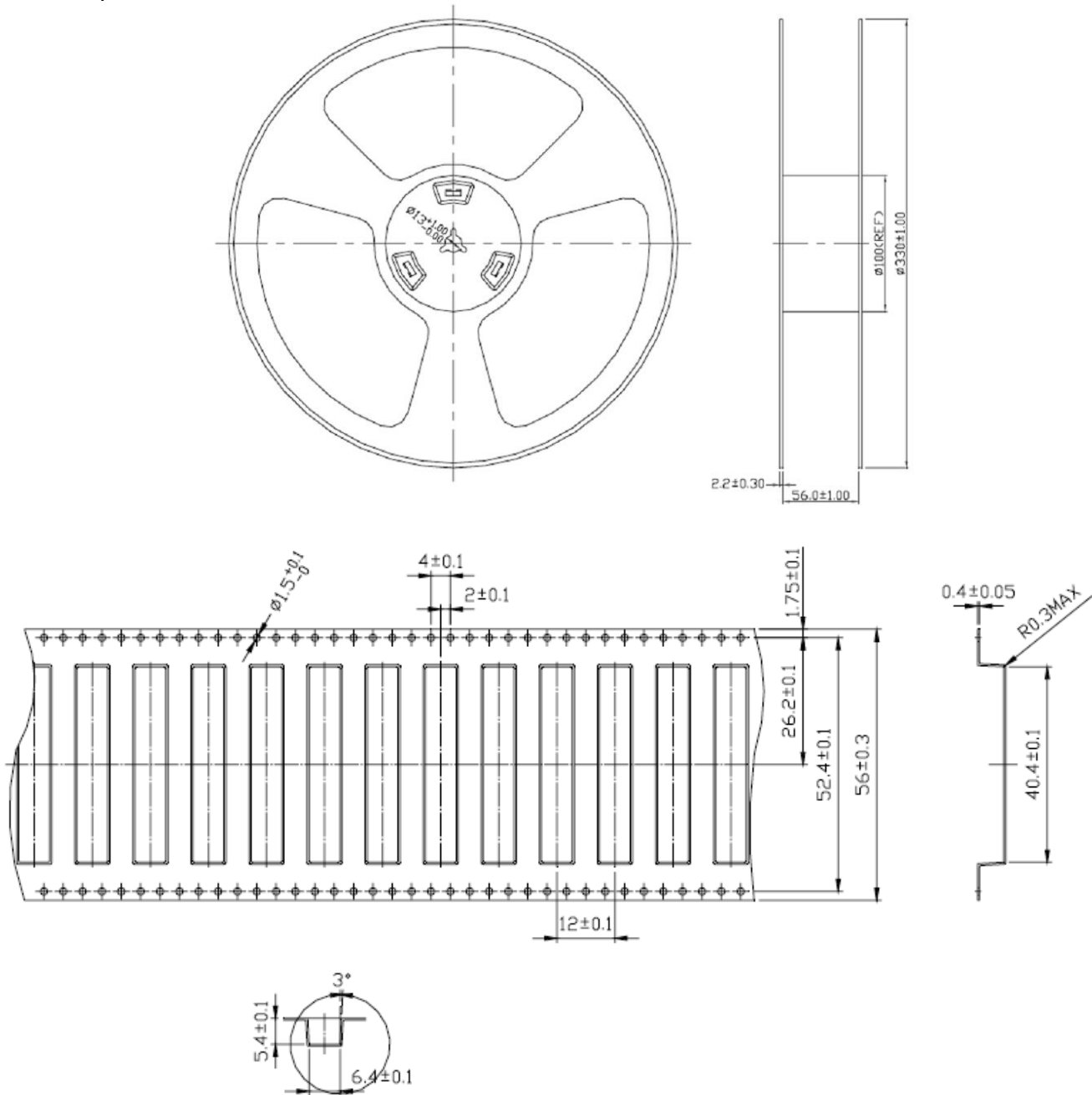
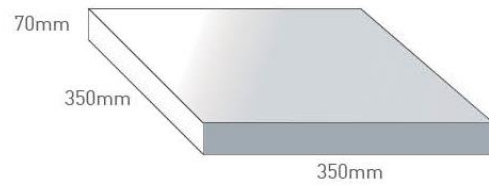

Figure 25. PA.711.A antenna packaging

PA.711.A

Packaging Specifications (2/2)

450 pc PA.711.A
1 reel in small inner box
Dimensions - 350*350*70
Weight - 2.4Kg



3 boxes / 1350 pcs in one carton
Carton Dimensions - 370*360*275
Weight - 7.9Kg

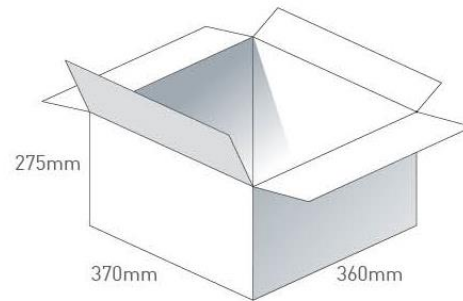

Pallet Dimensions 1110mm*720mm*1100mm
24 Cartons per Pallet
6 Cartons per layer
4 Layers

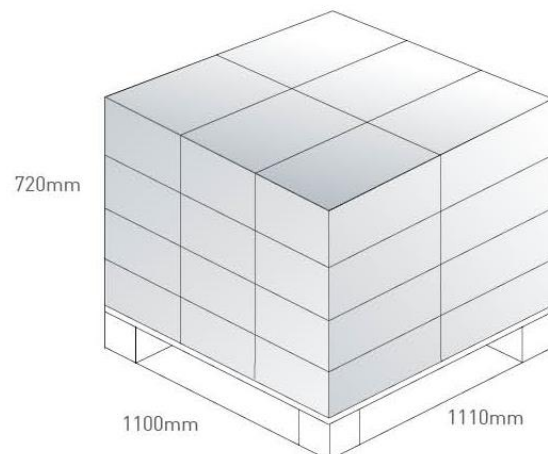

10 RECOMMENDED REFLOW TEMPERATURE PROFILE

PA.711.A can be assembled following either Sn-Pb or Pb-Free assembly processes. The recommended soldering temperatures are as follows:

Phase	Profile Features	Sn-Pb Assembly	Pb-Free Assembly (SnAgCu)
Ramp-Up	Avg. Ramp-Up Rate (T _{smax} to TP)	3°C/second (max)	3°C/second (max)
Preheat	Temperature Min (T _{smin})	100°	100°
	Temperature Max (T _{smax})	150°	150°
	Time (t _{smin} to t _{smax})	60-120 seconds	60-120 seconds
Reflow	Temperature (T _L)	183°C	217°C
	Total Time Above T _L b(t _L)	60-150 seconds	60-150 seconds
Peak	Temperature (T _p)	235°C	260°C
	Time (t _p)	10-30 seconds	20-40 seconds
Ramp-Down	Rate	6°C/second (max)	6°C/second (max)
Time from 25°C to peak Temperature		6 minutes max	8 minutes max

Temperature profile – (green area) for the assembly process in reflow ovens

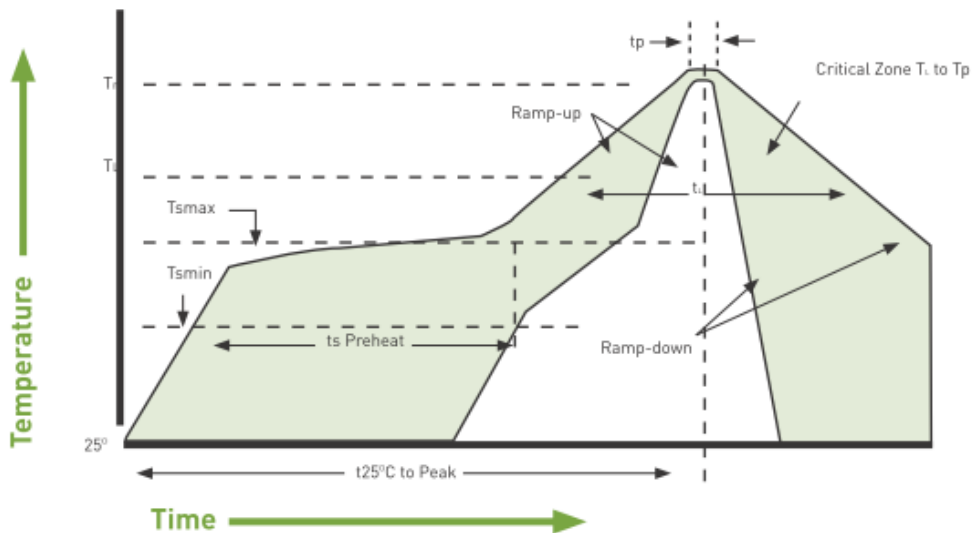

Figure 26. Temperature profile for the assembly process in reflow ovens

Taoglas makes no warranties based on the accuracy or completeness of the contents of this document and reserves the right to make changes to specifications and product descriptions at any time without notice. Taoglas reserves all rights to this document and the information contained herein. Reproduction, use or disclosure to third parties without express permission is strictly prohibited. Copyright © Taoglas Ltd.