

## SOT-23 Plastic-Encapsulate Transistors

### MMBTA42 TRANSISTOR (NPN)

#### FEATURES

- High breakdown voltage
- Low collector-emitter saturation voltage
- Complementary to MMBTA92 (PNP)

Marking: 1D

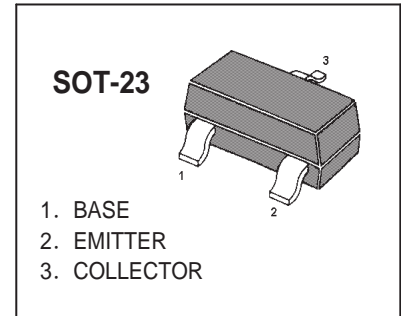

#### MAXIMUM RATINGS (T<sub>a</sub>=25°C unless otherwise noted)

Symbol	Parameter	Value	
V <sub>CBO</sub>	Collector-Base Voltage	300	V
V <sub>CEO</sub>	Collector-Emitter Voltage	300	V
V <sub>EBO</sub>	Emitter-Base Voltage	5	V
I <sub>C</sub>	Collector Current -Continuous	0.3	A
I <sub>CM</sub>	Collector Current-Peak	0.5	A
P <sub>C</sub>	Collector Power dissipation	0.35	W
R <sub>θJA</sub>	Thermal Resistance, junction to Ambient	357	°C/W
T <sub>J</sub>	Junction Temperature	150	°C
T <sub>stg</sub>	Storage Temperature	-55~+150	°C

#### ELECTRICAL CHARACTERISTICS (T<sub>a</sub>=25°C unless otherwise specified)

Parameter	Symbol	Test conditions	Min	Max	Unit
Collector-base breakdown voltage	V <sub>(BR)CBO</sub>	I <sub>C</sub> = 100μA, I <sub>E</sub> =0	300		V
Collector-emitter breakdown voltage	V <sub>(BR)CEO</sub>	I <sub>C</sub> = 1mA, I <sub>B</sub> =0	300		V
Emitter-base breakdown voltage	V <sub>(BR)EBO</sub>	I <sub>E</sub> = 100μA, I <sub>C</sub> =0	5		V
Collector cut-off current	I <sub>CBO</sub>	V <sub>CB</sub> =200V, I <sub>E</sub> =0		0.25	μA
Emitter cut-off current	I <sub>EBO</sub>	V <sub>EB</sub> = 5V, I <sub>C</sub> =0		0.1	μA
DC current gain	h <sub>FE(1)</sub>	V <sub>CE</sub> = 10V, I <sub>C</sub> = 1mA	60		
	h <sub>FE(2)</sub>	V <sub>CE</sub> = 10V, I <sub>C</sub> =10mA	100	200	
	h <sub>FE(3)</sub>	V <sub>CE</sub> =10V, I <sub>C</sub> =30mA	60		
Collector-emitter saturation voltage	V <sub>CE(sat)</sub>	I <sub>C</sub> =20mA, I <sub>B</sub> = 2mA		0.2	
Base-emitter saturation voltage	V <sub>BE(sat)</sub>	I <sub>C</sub> = 20mA, I <sub>B</sub> =2mA		0.9	
Transition frequency	f <sub>T</sub>	V <sub>CE</sub> = 20V, I <sub>C</sub> = 10mA, f=30MHz	50		MHz

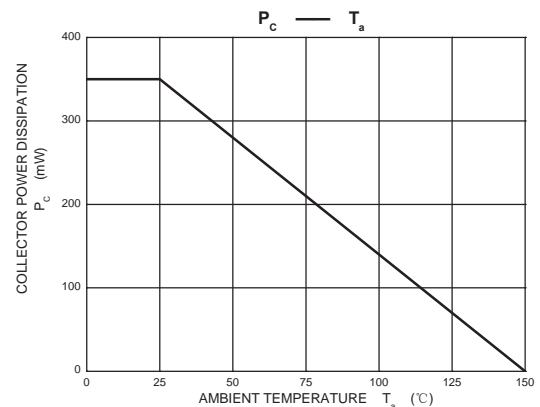
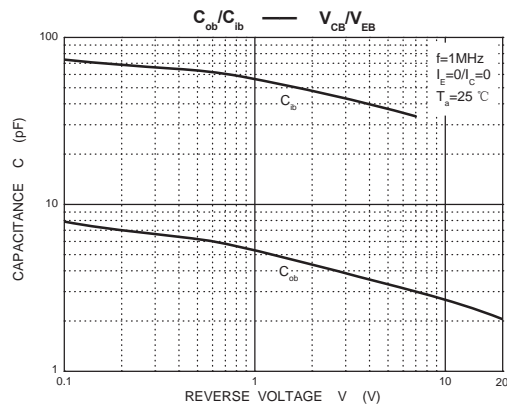
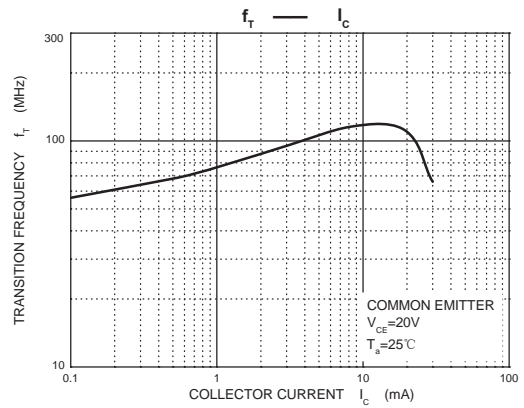
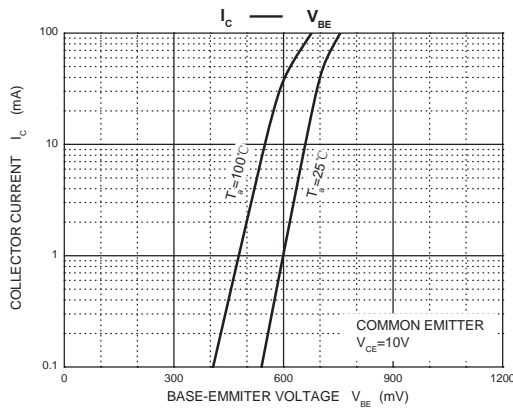
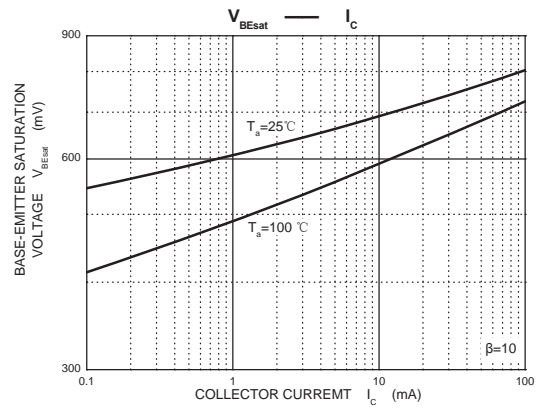
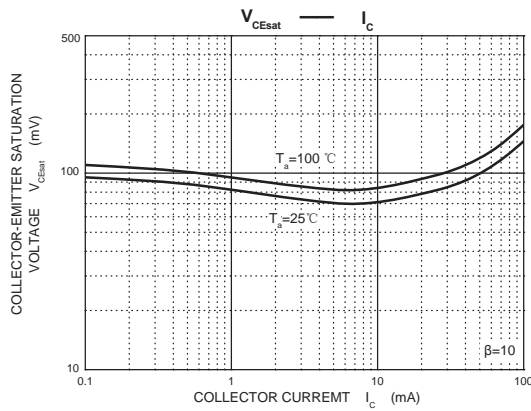
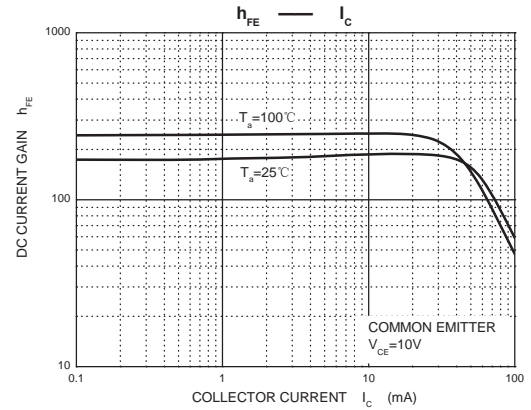
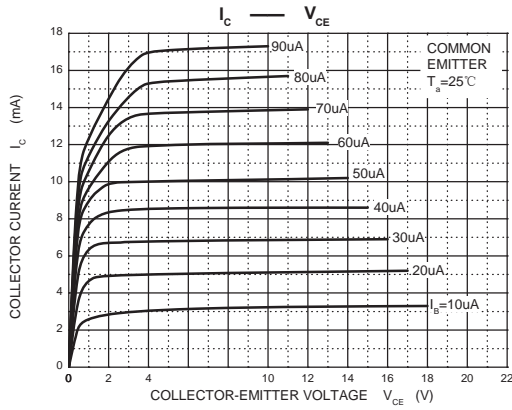

PACKAGE OUTLINE

Plastic surface mounted package; 3 leads

SOT-23

