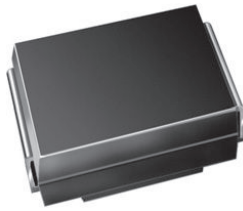

## Surface-Mount Ultrafast Plastic Rectifier

**SMB (DO-214AA)**

 Anode  Cathode 

### FEATURES

- Glass passivated pellet chip junction
- Ideal for automated placement
- Ultrafast recovery times for high efficiency
- Low forward voltage, low power losses
- High forward surge capability
- Meets MSL level 1, per J-STD-020, LF maximum peak of 260 °C
- AEC-Q101 qualified available
  - Automotive ordering code: base P/NHE3 or P/NHM3
- Material categorization: for definitions of compliance please see [www.vishay.com/doc?99912](http://www.vishay.com/doc?99912)

 AUTOMOTIVE  
GRADE  
Available

**RoHS**  
COMPLIANT  
HALOGEN  
**FREE**

### ADDITIONAL RESOURCES



3D Models

PRIMARY CHARACTERISTICS	
$I_{F(AV)}$	2.0 A
$V_{RRM}$	50 V, 100 V, 150 V, 200 V
$I_{FSM}$	50 A
$t_{rr}$	20 ns
$V_F$	0.90 V
$T_J$ max.	150 °C
Package	SMB (DO-214AA)
Circuit configuration	Single

### TYPICAL APPLICATIONS

For use in high frequency rectification and freewheeling application in switching mode converters and inverters for consumer, computer, automotive, and telecommunication.

### MECHANICAL DATA

**Case:** SMB (DO-214AA)

Molding compound meets UL 94 V-0 flammability rating

Base P/N-E3 - RoHS-compliant, commercial grade

Base P/N-M3 - halogen-free, RoHS-compliant, commercial grade

Base P/NHE3\_X - RoHS-compliant and AEC-Q101 qualified

Base P/NHME3\_X - halogen-free, RoHS-compliant, and AEC-Q101 qualified

("\_X" denotes revision code e.g. A, B, ....)

**Terminals:** matte tin plated leads, solderable per J-STD-002 and JESD 22-B102

E3, M3, HE3, and HM3 suffix meets JESD 201 class 2 whisker test

**Polarity:** color band denotes cathode end

MAXIMUM RATINGS ( $T_A = 25\text{ °C}$ unless otherwise noted)						
PARAMETER	SYMBOL	ES2A	ES2B	ES2C	ES2D	UNIT
Device marking code		EA	EB	EC	ED	
Maximum repetitive peak reverse voltage	$V_{RRM}$	50	100	150	200	V
Maximum RMS voltage	$V_{RMS}$	35	70	105	140	V
Maximum DC blocking voltage	$V_{DC}$	50	100	150	200	V
Maximum average forward rectified current at $T_L = 110\text{ °C}$	$I_{F(AV)}$	2.0				A
Peak forward surge current 8.3 ms single half sine-wave superimposed on rated load	$I_{FSM}$	50				A
Operating junction and storage temperature range	$T_J, T_{STG}$	-55 to +150				°C



ELECTRICAL CHARACTERISTICS (T <sub>A</sub> = 25 °C unless otherwise noted)							
PARAMETER	TEST CONDITIONS	SYMBOL	ES2A	ES2B	ES2C	ES2D	UNIT
Maximum instantaneous forward voltage	2.0 A	V <sub>F</sub> <sup>(1)</sup>	0.90				V
Maximum DC reverse current at rated DC blocking voltage		I <sub>R</sub>	T <sub>A</sub> = 25 °C			10	μA
			T <sub>A</sub> = 100 °C			350	
Max. reverse recovery time	I <sub>F</sub> = 0.5 A, I <sub>R</sub> = 1.0 A, I <sub>rr</sub> = 0.25 A	t <sub>rr</sub>	20				ns
Maximum reverse recovery time	I <sub>F</sub> = 2.0 A, V <sub>R</sub> = 30 V, dI/dt = 50 A/μs, I <sub>r</sub> = 10 % I <sub>RM</sub>	t <sub>rr</sub>	T <sub>J</sub> = 25 °C			30	ns
			T <sub>J</sub> = 100 °C			50	
Maximum stored charge	I <sub>F</sub> = 2.0 A, V <sub>R</sub> = 30 V, dI/dt = 50 A/μs, I <sub>r</sub> = 10 % I <sub>RM</sub>	Q <sub>rr</sub>	T <sub>J</sub> = 25 °C			10	nC
			T <sub>J</sub> = 100 °C			25	
Typical junction capacitance	4.0 V, 1 MHz	C <sub>J</sub>	18				pF

Note

(1) Pulse test: 300 ms pulse width, 1 % duty cycle

THERMAL CHARACTERISTICS (T <sub>A</sub> = 25 °C unless otherwise noted)						
PARAMETER	SYMBOL	ES2A	ES2B	ES2C	ES2D	UNIT
Typical thermal resistance	R <sub>θJA</sub> <sup>(1)</sup>	75				°C/W
	R <sub>θJL</sub> <sup>(1)</sup>	20				

Note

(1) Units mounted on PCB 5.0 mm x 5.0 mm (0.013 mm thick) land areas

ORDERING INFORMATION (Example)				
PREFERRED P/N	UNIT WEIGHT (g)	PREFERRED PACKAGE CODE	BASE QUANTITY	DELIVERY MODE
ES2D-E3/52T	0.096	52T	750	7" diameter plastic tape and reel
ES2D-E3/5BT	0.096	5BT	3200	13" diameter plastic tape and reel
ES2DHE3_A/H <sup>(1)</sup>	0.096	H	750	7" diameter plastic tape and reel
ES2DHE3_A/I <sup>(1)</sup>	0.096	I	3200	13" diameter plastic tape and reel
ES2D-M3/52T	0.096	52T	750	7" diameter plastic tape and reel
ES2D-M3/5BT	0.096	5BT	3200	13" diameter plastic tape and reel
ES2DHM3_A/H <sup>(1)</sup>	0.096	H	750	7" diameter plastic tape and reel
ES2DHM3_A/I <sup>(1)</sup>	0.096	I	3200	13" diameter plastic tape and reel

Note

(1) AEC-Q101 qualified

## RATINGS AND CHARACTERISTICS CURVES ( $T_A = 25\text{ }^\circ\text{C}$ unless otherwise noted)

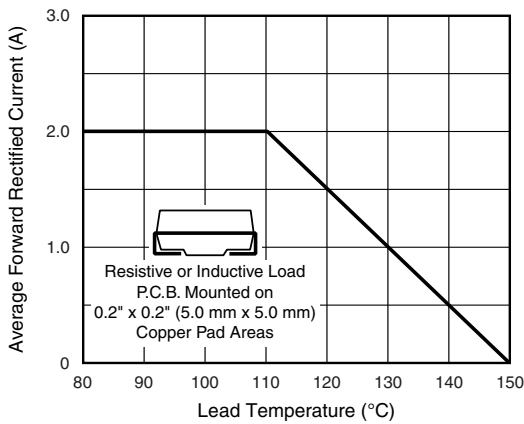

Fig. 1 - Maximum Forward Current Derating Curve

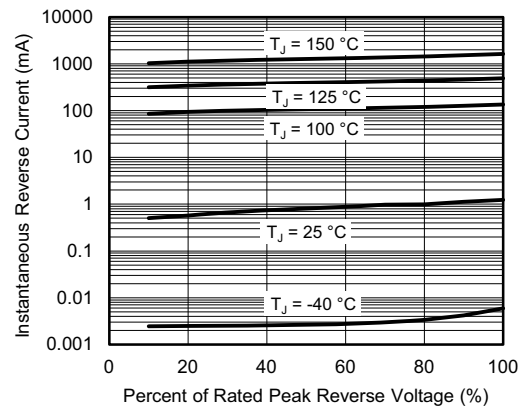

Fig. 4 - Typical Reverse Leakage Characteristics

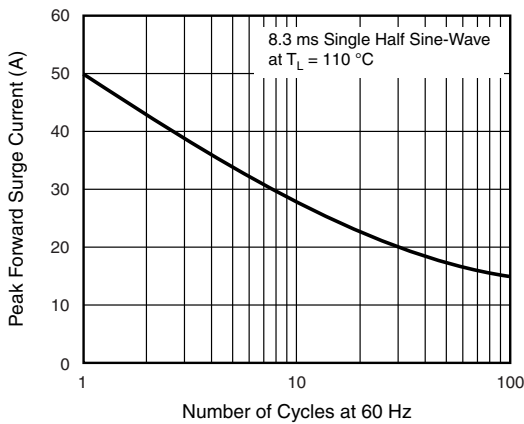

Fig. 2 - Maximum Non-Repetitive Peak Forward Surge Current

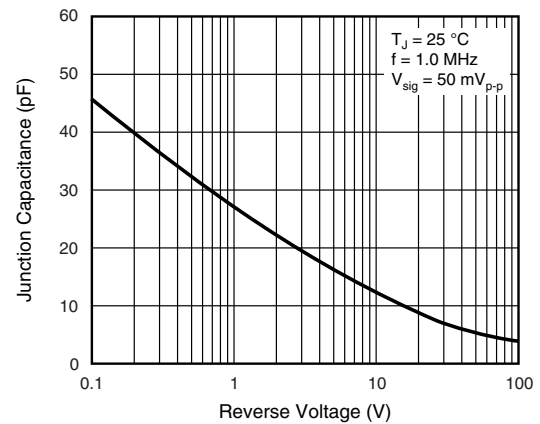

Fig. 5 - Typical Junction Capacitance

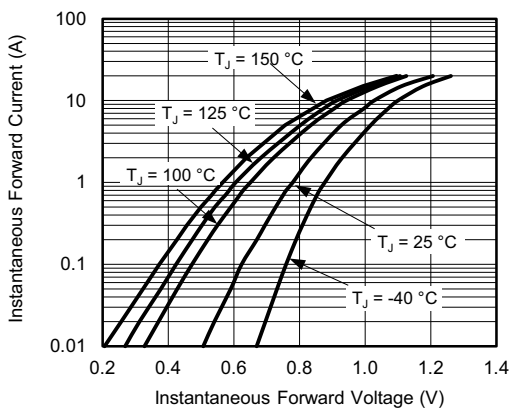

Fig. 3 - Typical Instantaneous Forward Characteristics

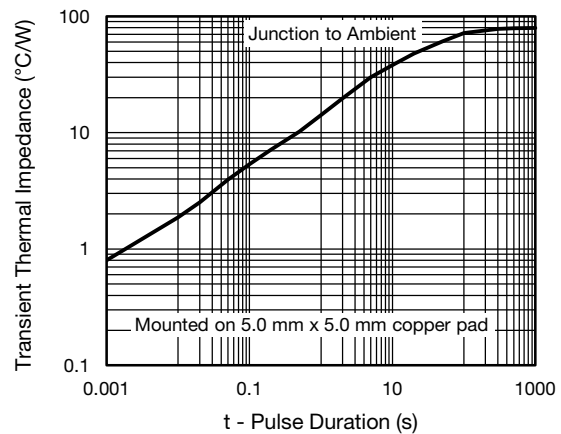
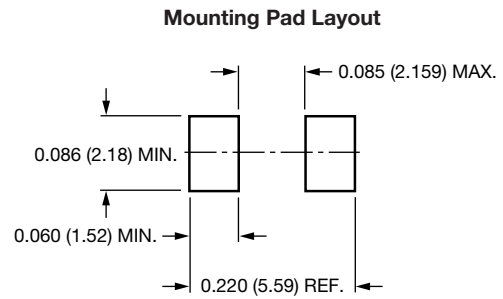
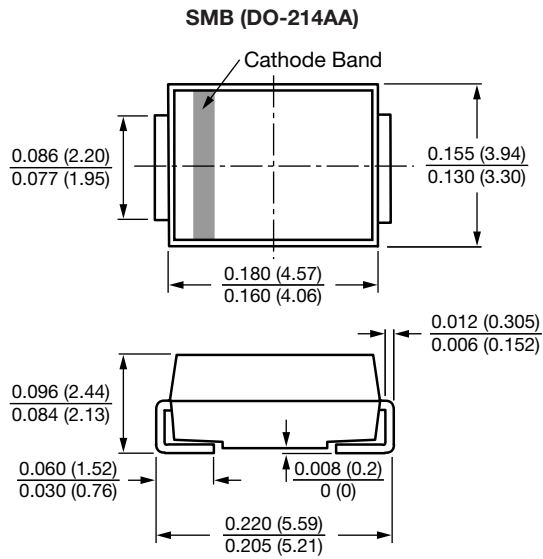

Fig. 6 - Transient Thermal Impedance



## PACKAGE OUTLINE DIMENSIONS in inches (millimeters)





## **Disclaimer**

ALL PRODUCT, PRODUCT SPECIFICATIONS AND DATA ARE SUBJECT TO CHANGE WITHOUT NOTICE TO IMPROVE RELIABILITY, FUNCTION OR DESIGN OR OTHERWISE.

Vishay Intertechnology, Inc., its affiliates, agents, and employees, and all persons acting on its or their behalf (collectively, "Vishay"), disclaim any and all liability for any errors, inaccuracies or incompleteness contained in any datasheet or in any other disclosure relating to any product.

Vishay makes no warranty, representation or guarantee regarding the suitability of the products for any particular purpose or the continuing production of any product. To the maximum extent permitted by applicable law, Vishay disclaims (i) any and all liability arising out of the application or use of any product, (ii) any and all liability, including without limitation special, consequential or incidental damages, and (iii) any and all implied warranties, including warranties of fitness for particular purpose, non-infringement and merchantability.

Statements regarding the suitability of products for certain types of applications are based on Vishay's knowledge of typical requirements that are often placed on Vishay products in generic applications. Such statements are not binding statements about the suitability of products for a particular application. It is the customer's responsibility to validate that a particular product with the properties described in the product specification is suitable for use in a particular application. Parameters provided in datasheets and / or specifications may vary in different applications and performance may vary over time. All operating parameters, including typical parameters, must be validated for each customer application by the customer's technical experts. Product specifications do not expand or otherwise modify Vishay's terms and conditions of purchase, including but not limited to the warranty expressed therein.

Except as expressly indicated in writing, Vishay products are not designed for use in medical, life-saving, or life-sustaining applications or for any other application in which the failure of the Vishay product could result in personal injury or death. Customers using or selling Vishay products not expressly indicated for use in such applications do so at their own risk. Please contact authorized Vishay personnel to obtain written terms and conditions regarding products designed for such applications.

No license, express or implied, by estoppel or otherwise, to any intellectual property rights is granted by this document or by any conduct of Vishay. Product names and markings noted herein may be trademarks of their respective owners.