

GTXO-C74T

3.3V TCXO with CMOS Output and Low Phase Noise

- Low phase noise
- CMOS output
- Miniature SM package
- Sealed crystal design

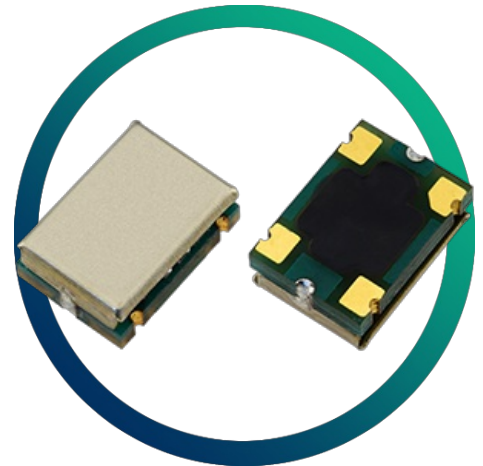

CONFIGURABLE OPTIONS

Parameter	Option Code
Frequency	
Frequency stability	
Any	
±2.5ppm	J
±2.0ppm	H
±1.5ppm	G
Temperature range	
Any	
-20 to +70 °C	N
-30 to +75 °C	S
-40 to +85 °C	I

SPECIFICATIONS

Frequency range	30.0 ~ 61.44MHz
Dimensions	7.0 x 5.0 x 2.5mm
Storage temperature range	-40 to +85°C
Supply voltage stability	±1.0ppm, V_{DD} ±5%
Driving ability	15pF CMOS
Logic levels	'0' level = 10% V_{DD} max '1' level = 90% V_{DD} min
Waveform symmetry	45:55 @ 50% V_{DD}
Ageing	±1.0ppm max first year
Supply voltage (V_{DD})	+3.3V ±5%
Supply current	20.0mA max
Start up time	3ms max
Frequency adjustment	None
Phase noise (typ @ 61.44MHz)	-84dBc/Hz @ 10Hz -115dBc/Hz @ 100Hz -141dBc/Hz @ 1kHz -154dBc/Hz @ 10kHz
Preset frequency @ 25°C	±2.0ppm max

PACKAGE DRAWING

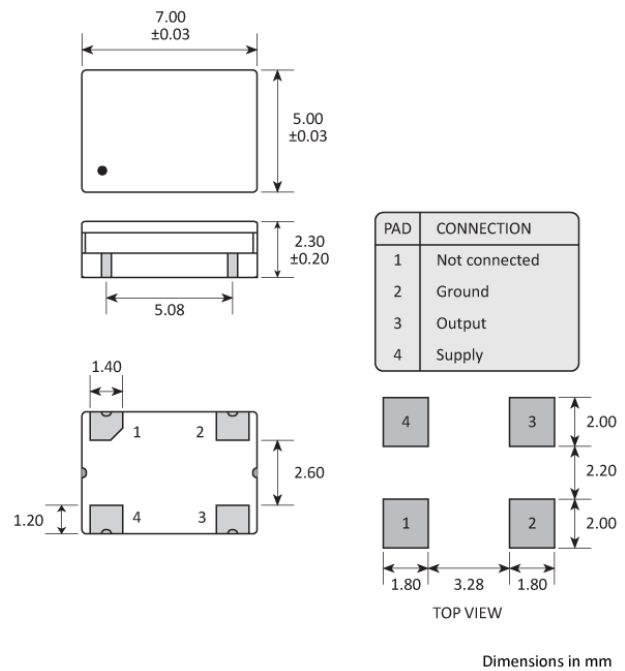

ORDERING INFORMATION

To request a quotation for the GTXO-C74T please use the configurable options form to choose the options you require and then submit your configured product to our team. Our expert advisers are always happy to help with your requirements and can be contacted on +44 1460 256 100 or at sales@golledge.com.

Following product selection you will be issued with a seven character Golledge part number. Your Golledge part number is the internationally accepted Golledge manufacturing part number (MPN) that should be used for all project documentation, including bills of materials (BoMs) and purchase orders.

If you have any queries regarding any of our documentation our dedicated sales team will be happy to help.

MARKING

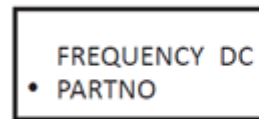

• Pin 1
Marking type: Laser

DC = Date Code in YM, eg. "GF" = Jun 2017

	A	B	C	D	E	F	G	H	J	K	L	M
Y	1	2	3	4	5	6	7	8	9	0		
M	Jan	Feb	Mar	Apr	May	Jun	Jul	Aug	Sep	Oct	Nov	Dec

SOLDERING PROFILE

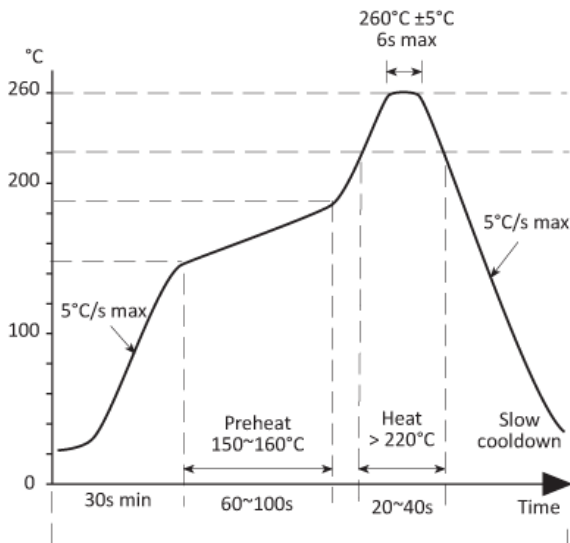

TAPE & REEL SPECIFICATION

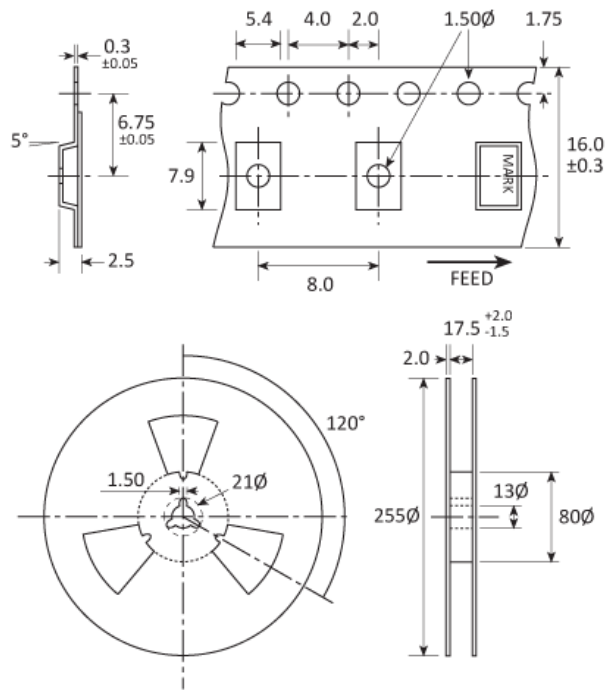

Dimensions in mm

HANDLING & STORAGE



Human Body Model (HBM) 1A (250V to <500V)





Moisture Sensitivity Level (MSL): 1 (or not applicable)

CONSTRUCTION

- PCB carrier
- Metal screening lid

MATERIAL COMPOSITION

 Lead-free (< 0.1% by weight)

 RoHS 2 compliant with no exemptions. [See our declaration](#)

 REACH compliant. [See our statement](#)

 Free of conflict minerals. [See our declaration](#)

 Free of Halogens. [See our declaration](#)

 Free of Ozone-depleting substances. [See our declaration](#)

OTHER INFORMATION

About Golledge

We are the UK's leading supplier of frequency control products and are proud to serve the global electronics industry. Our philosophy is a focus firmly on your requirements by striving to meet and exceed your needs. We do this by ensuring the utmost quality and consistency in our products and services. If you have any queries about the Golledge service or any of our products please get in touch, we'd love to hear from you.

Come and visit

Eaglewood Park, ILMINSTER,
Somerset, TA19 9DQ, England

Give us a call

Tel: +44 1460 256 100
Fax: +44 1460 256 101

Email us

sales@golledge.com

Our Worldwide Distributors

Belgium & Luxembourg

Alcom Electronics NV/SA



Email info@alcom.be
Web www.alcom.be
Tel +32 (0)3 458.30.33

China, Hong Kong - 中国 / 香港

Meiya China



Email sales@meiyatech.com
Web www.meiyatech.com
Tel +86 755 2823 1923

France

Equipments Scientifique



Email comp@es-france.com
Web www.es-france.com
Tel +33 1 47 95 99 89

Germany

MEV Elektronik Service GmbH



Email info@mev-elektronik.com
Web www.mev-elektronik.com
Tel +49 54 24 23 40-0

India

V5 Semiconductors



Email sales@v5semiconductors.com
Web v5semiconductors.com
Tel +91-80-2661 0621

Israel

Phoenix Technologies Ltd



Email sales@phnx.co.il
Web www.phnx.co.il
Tel +972 9 764 4800

Netherlands

Alcom Electronics BV



Email info@alcom.nl
Web alcom.nl
Tel +31 (0)10 288.25.00

Norway

Link Nordic



Email bjorn.nyjordet@linknordic.com
Web linknordic.com
Tel +47 93 22 68 90

Russia - Россия

EFO Ltd



Email elena@efo.ru
Web www.golledge.ru
Tel +7(812)327-8654

Spain & Portugal

R.C. Microelectronica, S.A.



Email ventas@rcmicro.es
Web www.rcmicro.es
Tel +34 93 260 21 66

Our customer feedback is testament to our quality; "Never had such good service as this from anyone in 35 years of being in the industry, this is impressive and has really helped us out of a corner to keep the design flowing" Andy (Senior Design Engineer), "As always your support is state of the art" Nicoleta (Material Management), "Legendary work - as usual it has to be said" John (Operations).

To take advantage of our highly praised service get in touch with us today.