

SERIES 62M Magnetic Detent

FEATURES

- Ultra Smooth Magnetic Detent
- 3 Million Rotational Cycles, Ten Times the Life of a Mechanical Detent System
- Optional Integrated Pushbutton
- Available in 24 Positions
- Choice of Cable Lengths

Applications

- Medical
- Audio
- Instrumentation

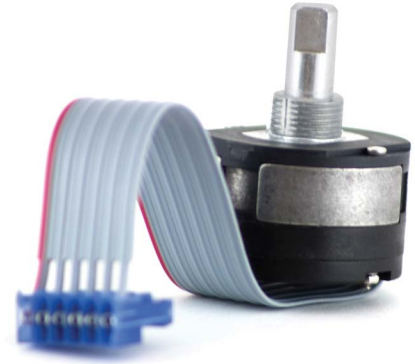

DIMENSIONS in inches (and millimeters)

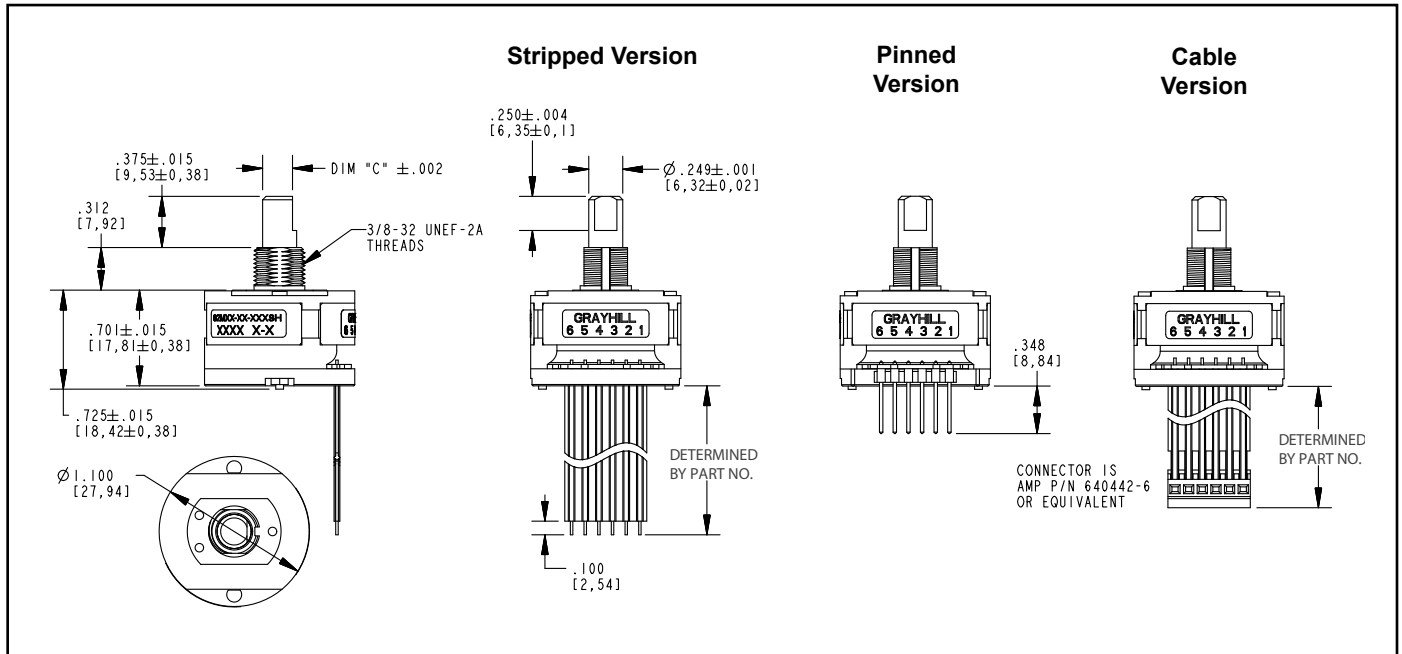

Optical and Mechanical Encoders

SWITCH SCHEMATIC

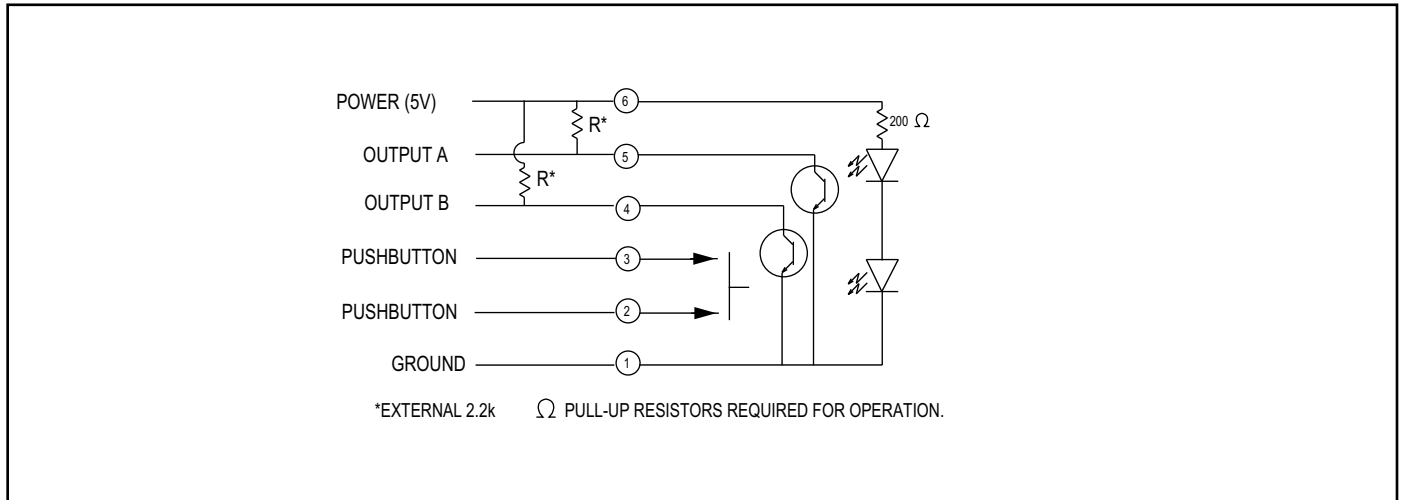

WAVEFORM AND TRUTH TABLE

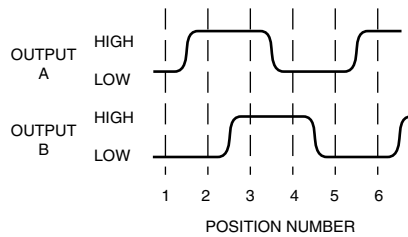

Clockwise Rotation		
Position	Output A	Output B
1		
2	•	
3	•	•
4		•

• Indicates logic high; blank indicates logic low. Code repeats every 4 positions.

SPECIFICATIONS

Environmental Specifications

Operating Temperature Range: -40° C to 85° C

Storage Temperature Range: -55° C to 100° C

Humidity: 96 hours at 90-95% humidity at 40° C

Mechanical Vibration: Harmonic motion with amplitude of 15 g, within a varied frequency of 10 to 2000 Hz

Mechanical Shock:

Test 1: 100 g for 6 ms half-sine wave with a velocity change of 12.3 ft/sec

Test 2: 100 g for 6 ms sawtooth wave with a velocity change of 9.7 ft/sec

Rotary Electrical and

Mechanical Specifications

Operating Voltage: 5.00±.25 Vdc

Supply Current: 30 mA maximum at 5 Vdc

Output: Open collector phototransistor, external pull-up resistors are required.

Output Code: Two-bit quadrature, channel A leads channel B by 90° electrically during clockwise rotation of the shaft

Logic Output Characteristics:

Logic high signal shall be no less than 3.0 Vdc

Logic low signal shall be no greater than 1.0 Vdc

Minimum Sink Current: 2.0 mA

Power Consumption: 150 mW maximum

Mechanical Life: 3 million rotational cycles of operation. One cycle is a rotation through all positions and a full return

Rotational Torque: H=1.70 ± 1.00 in-oz,

M=1.25 ± 0.75 in-oz, L=0.75 ± 0.5 in-oz

Mounting Torque: 15 in-oz maximum

Shaft Pull-Out Force: 45 lbs minimum

Shaft Push-Out Force: 45 lbs minimum

Terminal Strength: 15 lbs minimum terminal pull-out force for cable or header termination

Solderability: 95% free of pin holes and voids

Pushbutton Electrical and Mechanical Specifications

Rating: 10 mA at 5 Vdc

Contact Resistance: <10 ohms

Life: 3 million actuations minimum

Contact Bounce: <4 ms make, <10 ms break

Actuation Force: 2=200±75 grams,

3=300±90 grams, 4=510±150 grams

Shaft Travel: .025 ± .010 inches

Materials and Finishes

Bushing: Zinc Diecast, Cadmium Plated per QQP-416, Class II, Type II

Insert Molded into 25% Glass Reinforced

Nylon Zytel FR-50

Shaft: NdFeB XE-3594 over Aluminum

Stator: Powdered Metal per F-0000-20

Through Bolts: 305 Stainless Steel

Through Bolts Nuts: Stainless Steel

Spacer Washer: Brass

Snap Dome: Stainless Steel

Printed Circuit Boards: Nema Grade FR4, Double Clad with Copper, Plated with Gold over Nickel

Infrared Light Emitting Diode Chips:

Gallium Aluminum Arsenide

Silicon Phototransistor Chips: Gold and Aluminum Alloys

Resistor: Metal Oxide on Ceramic Substrate

Solder Pins: Brass, Plated with Tin

Code Rotor: Acetal (Delrin 100)

Code Housing: Polyamide Polymer (Nylon 6/10 Alloy)

Backplate Strain Relief: Polyamide Polymer (Nylon 6/10 Alloy - Hiloy-610)

Cable: Copper Standard with Topcoat in PVC Insulation (Cabled Versions Only)

Connector: PA4.6 with Tin Plated Copper Alloy (Cable/Connector Versions)

Label: TT406 Thermal Transfer Cast Film

Solder: Sn/Ag/Cu, Lead Free, No Clean

Mounting Hex Nut: Cadmium over 1/2 Hard Brass

Lockwasher: 8-18 Stainless Steel, Passivate Finish

Pin Header: Hi-Temp Glass Filled Thermoplastic UL94V-0, Phosphor Bronze (Pinned Versions Only)

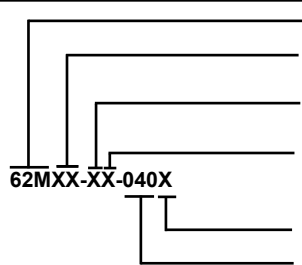

Series

Angle of Throw: 15 = 15° for code change and 24 detent positions

Rotational Torque: H=High Torque (1.70 in-oz), M=Medium Torque (1.25 in-oz), L=Low Torque (0.75 in-oz)

Pushbutton Option: 0=Non-Pushbutton, 2 = 200 grams, 3 = 300 grams, 4 = 510 grams

Termination: CH = .100 Cable with Connector, SH = Cable with Stripped-End, PH = Pin Header

Cable Termination: 040 = 4.0in. Cable is terminated with Amp Connector P/N 3-640442-6. See Amp Mateability Guide for mating connector details.

*Eliminate cable length if ordering pins (Ex: 62M22-42-PH)