

PLEASE CHECK WWW.MOLEX.COM FOR LATEST PART INFORMATION

Part Number: [0750885005](#)
Status: **Active**
Overview: vhdm_hsd
Description: 2.00mm (.079") Pitch 5-Row VHDM-HSD™ Backplane Header, Polarizing Pin Module, Code Key E, 40 Circuits

Documents:

[Drawing \(PDF\)](#) [RoHS Certificate of Compliance \(PDF\)](#)

General

Product Family	Backplane Connectors
Series	75088
Application	Backplane
Application Tooling Documents	Tooling Manual
Comments	Position E
Component Type	PCB Header
Overview	vhdm_hsd
Product Name	VHDM-HSD™
Style	N/A

Physical

Circuits (Loaded)	N/A
Circuits (maximum)	0
Durability (mating cycles max)	200
First Mate / Last Break	No
Guide to Mating Part	Yes
Keying to Mating Part	Yes
Material - Metal	Zinc Alloy
Number of Columns	10
Number of Pairs	Open Pin Field
Number of Rows	0
Orientation	Vertical
PC Tail Length (in)	0.000 In
PC Tail Length (mm)	0.00 mm
PCB Locator	Yes
PCB Retention	None
PCB Thickness Recommended (in)	0.173 In
PCB Thickness Recommended (mm)	4.40 mm
Packaging Type	Bag
Pitch - Mating Interface (in)	0.000 In
Pitch - Mating Interface (mm)	0.00 mm
Pitch - Term. Interface (in)	0.000 In
Pitch - Term. Interface (mm)	0.00 mm
Polarized to PCB	Yes
Stackable	No
Surface Mount Compatible (SMC)	No
Temperature Range - Operating	N/A

Electrical

Current - Maximum per Contact	N/A
Data Rate	5.0 Gbps
Shielded	No
Voltage - Maximum	N/A

Material Info

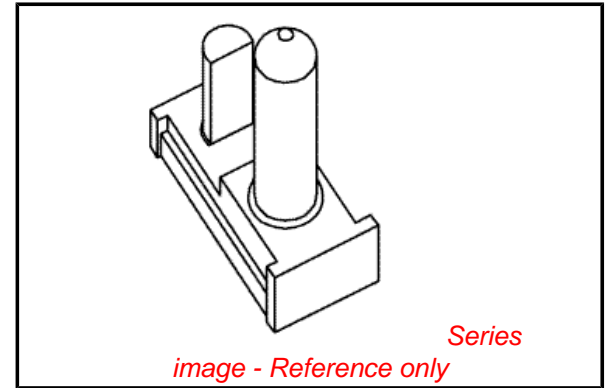

EU RoHS

ELV and RoHS Compliant
REACH SVHC
 Not Reviewed
Halogen-Free Status
 Not Reviewed

China RoHS



Need more information on product environmental compliance?

Email productcompliance@molex.com
 For a multiple part number RoHS Certificate of Compliance, [click here](#)

Please visit the [Contact Us](#) section for any non-product compliance questions.

Search Parts in this Series

[75088Series](#)

Reference - Drawing Numbers





Sales Drawing

SD-75088-002

VHDM-HSD is a trademark of Amphenol Corporation

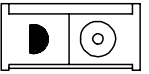
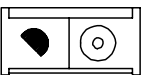
This document was generated on 05/28/2010

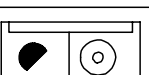
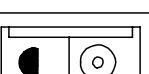
PLEASE CHECK WWW.MOLEX.COM FOR LATEST PART INFORMATION

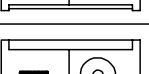
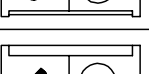
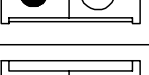
PART NUMBER	KEY POSITION
75088-5001	A 
75088-5002	B 
75088-5003	C 
75088-5004	D 
75088-5005	E 
75088-5006	F 
75088-5007	G 
75088-5008	H 
75088-5000	N/A 

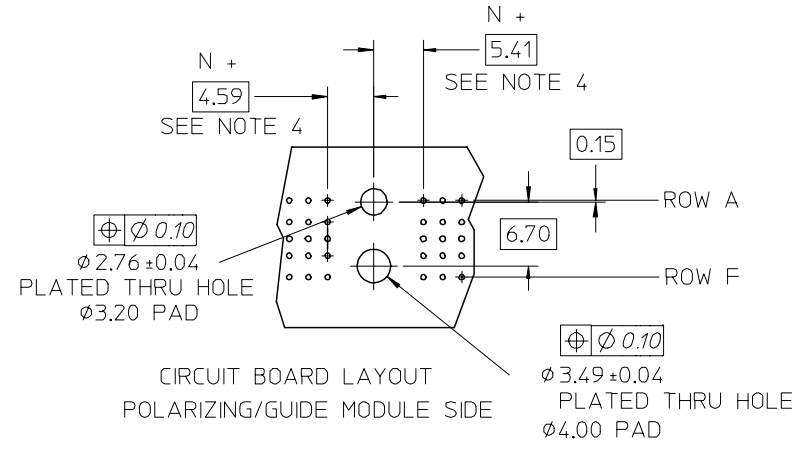
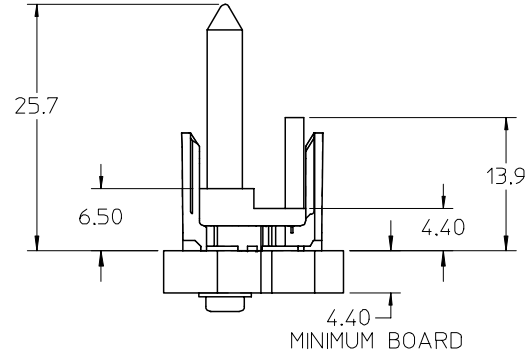
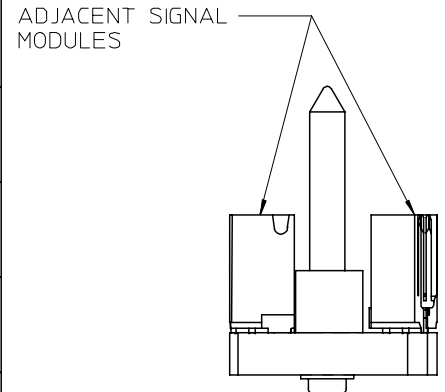
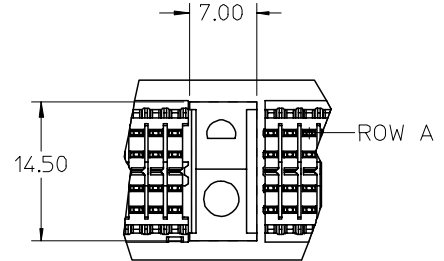

BILL OF MATERIAL 75088-500*

ITEM	DESCRIPTION	QTY.
1	GUIDANCE AND POLARIZING MODULE	1
2	SCREW AND WASHER (PCB >4.4 - 9.0)	1

- NOTES:
- MATERIAL:
ZINC ALLOY
 - THIS PART CONFORMS TO MOLEX PRODUCT SPECIFICATION PS-74031-999
 - PACKAGING:
STANDARD BULK PACK, 100 PER BAG
SCREWS PACKAGED SEPARATELY
 - "N" MUST BE 0 OR A MULTIPLE OF 2.00

ADDED 75088-5000 EC NO: UCP2004-0182 DRWN: JONIAK 2004/01/27 CHKD: JLAURX 2004/01/27 APPR: SREED 2004/01/27	QUALITY SYMBOLS	GENERAL TOLERANCES (UNLESS SPECIFIED)	SCALE 2:1	DESIGN UNITS METRIC	THIRD ANGLE PROJECTION	REVISE ON CAD ONLY
	▼ = 0 ▽ = 0	mm	INCH	DIMENSION STYLE MM ONLY		TITLE VHDM 5 ROW HSD BACKPLANE POLAR/GUIDE MODULE SALES ASSEMBLY
		4 PLACES ± --- ± ---	3 PLACES ± --- ± ---	DRAWN BY JBINGHAM	DATE 02/02/13	
	DESCRIPTION	ANGULAR ± ---°	DRAFT WHERE APPLICABLE	CHECKED BY NMARTIN	DATE 02/02/13	 MOLEX INCORPORATED
REV	MUST REMAIN WITHIN DIMENSIONS	THIS DRAWING CONTAINS INFORMATION THAT IS PROPRIETARY TO MOLEX INCORPORATED AND SHOULD NOT BE USED WITHOUT WRITTEN PERMISSION	APPROVED BY CBIXLER	DATE 02/02/13		