

FAIRCHILD

A Schlumberger Company

IRF320-323/IRF720-723
MTP3N35/3N40 7-39-11
N-Channel Power MOSFETs,
3.0 A, 350-400 V

Power And Discrete Division

Description

These devices are n-channel, enhancement mode, power MOSFETs designed especially for high speed applications, such as switching power supplies, converters, AC and DC motor controls, relay and solenoid drivers and other pulse circuits.

- Low $R_{DS(on)}$
- V_{GS} Rated at ± 20 V
- Silicon Gate for Fast Switching Speeds
- I_{DSS} , $V_{DS(on)}$, Specified at Elevated Temperature
- Rugged
- Low Drive Requirements
- Ease of Paralleling

TO-204AA

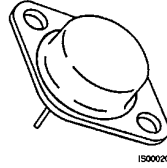

IRF320
 IRF321
 IRF322
 IRF323

TO-220AB

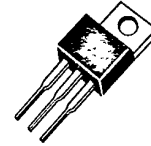

IRF720
 IRF721
 IRF722
 IRF723
 MTP3N35
 MTP3N40

Product Summary

Part Number	V_{DSS}	$R_{DS(on)}$	I_D at $T_C = 25^\circ C$	I_D at $T_C = 100^\circ C$	Case Style
IRF320	400 V	1.8 Ω	3.0 A	2.0 A	TO-204AA
IRF321	350 V	1.8 Ω	3.0 A	2.0 A	
IRF322	400 V	2.5 Ω	2.5 A	1.5 A	
IRF323	350 V	2.5 Ω	2.5 A	1.5 A	
IRF720	400 V	1.8 Ω	3.0 A	2.0 A	TO-220AB
IRF721	350 V	1.8 Ω	3.0 A	2.0 A	
IRF722	400 V	2.5 Ω	2.5 A	1.5 A	
IRF723	350 V	2.5 Ω	2.5 A	1.5 A	
MTP3N35	350 V	3.3 Ω	3.0 A	2.0 A	
MTP3N40	400 V	3.3 Ω	3.0 A	2.0 A	

Notes

For information concerning connection diagram and package outline, refer to Section 7.

IRF320-323/IRF720-723
MTP3N35/3N40

F-39-11

Maximum Ratings

Symbol	Characteristic	Rating IRF320/322 IRF720/722 MTP3N40	Rating IRF321/323 IRF721/723 MTP3N35	Unit
V _{DSS}	Drain to Source Voltage ²	400	350	V
V _{DGR}	Drain to Gate Voltage ² R _{GS} = 20 kΩ	400	350	V
V _{GS}	Gate to Source Voltage	± 20	± 20	V
T _J , T _{stg}	Operating Junction and Storage Temperatures	-55 to +150	-55 to +150	°C
T _L	Maximum Lead Temperature for Soldering Purposes, 1/8" From Case for 5 s	275	275	°C

Maximum Thermal Characteristics

		IRF320-323/ IRF720-723	MTP3N35/3N40	
R _{θJC}	Thermal Resistance, Junction to Case	3.12	1.67	°C/W
R _{θJA}	Thermal Resistance, Junction to Ambient	30/80	80	°C/W
P _D	Total Power Dissipation at T _C = 25°C	40	75	W
I _{DM}	Pulsed Drain Current ²	12	12	A

Electrical Characteristics (T_C = 25°C unless otherwise noted)

Symbol	Characteristic	Min	Max	Unit	Test Conditions
--------	----------------	-----	-----	------	-----------------

Off Characteristics

V _{(BR)DSS}	Drain Source Breakdown Voltage ¹ IRF320/322/720/722/ MTP3N40 IRF321/323/721/723/ MTP3N35			V	V _{GS} = 0 V, I _D = 250 μA
		400			
		350			
I _{DSS}	Zero Gate Voltage Drain Current		250	μA	V _{DS} = Rated V _{DSS} , V _{GS} = 0 V
			1000	μA	V _{DS} = 0.8 x Rated V _{DSS} , V _{GS} = 0 V, T _C = 125°C
I _{GSS}	Gate-Body Leakage Current IRF320-323 IRF720-723/MTP3N35/3N40		± 100 ± 500	nA	V _{GS} = ± 20 V, V _{DS} = 0 V

IRF320-323/IRF720-723
MTP3N35/3N40

T-39-11

Electrical Characteristics (Cont.) ($T_C = 25^\circ\text{C}$ unless otherwise noted)

Symbol	Characteristic	Min	Max	Unit	Test Conditions
On Characteristics					
$V_{GS(th)}$	Gate Threshold Voltage			V	$I_D = 250 \mu\text{A}$, $V_{DS} = V_{GS}$ $I_D = 1 \text{ mA}$, $V_{DS} = V_{GS}$
	IRF320-323/IRF720-723	2.0	4.0		
	MTP3N35/40	2.0	4.5		
$R_{DS(on)}$	Static Drain-Source On-Resistance ²			Ω	$V_{GS} = 10 \text{ V}$, $I_D = 1.5 \text{ A}$
	IRF320/321/720/721		1.8		
	IRF322/323/722/723		2.5		
	MTP3N35/40		3.3		
$V_{DS(on)}$	Drain-Source On-Voltage ²		12	V	$V_{GS} = 10 \text{ V}$; $I_D = 3.0 \text{ A}$;
	MTP3N35/40		10	V	$V_{GS} = 10 \text{ V}$; $I_D = 1.5 \text{ A}$; $T_C = 100^\circ\text{C}$
g_{fs}	Forward Transconductance	1.0		S (Ω)	$V_{DS} = 10 \text{ V}$, $I_D = 1.5 \text{ A}$

Dynamic Characteristics

C_{iss}	Input Capacitance		500	pF	$V_{DS} = 25 \text{ V}$, $V_{GS} = 0 \text{ V}$ $f = 1.0 \text{ MHz}$
C_{oss}	Output Capacitance		100	pF	
C_{rss}	Reverse Transfer Capacitance		40	pF	

Switching Characteristics ($T_C = 200^\circ\text{C}$, Figures 1, 2)³

$t_{d(on)}$	Turn-On Delay Time		40	ns	$V_{DD} = 200 \text{ V}$, $I_D = 1.5 \text{ A}$ $V_{GS} = 10 \text{ V}$, $R_{GEN} = 50 \Omega$ $R_{GS} = 50 \Omega$
t_r	Rise Time		50	ns	
$t_{d(off)}$	Turn-Off Delay Time		100	ns	
t_f	Fall Time		50	ns	
Q_g	Total Gate Charge		15	nC	$V_{GS} = 10 \text{ V}$, $I_D = 4.0 \text{ A}$ $V_{DD} = 200 \text{ V}$

Symbol	Characteristic	Typ	Max	Unit	Test Conditions
Source-Drain Diode Characteristics					
V_{SD}	Diode Forward Voltage		1.6	V	$I_S = 3.0 \text{ A}$; $V_{GS} = 0 \text{ V}$
	IRF320/321/720/721		1.5	V	$I_S = 2.5 \text{ A}$; $V_{GS} = 0 \text{ V}$
t_{rr}	Reverse Recovery Time	450		ns	$I_F = 3.0 \text{ A}$; $di_S/dt = 100 \text{ A}/\mu\text{S}$

Notes

- $T_J = +25^\circ\text{C}$ to $+150^\circ\text{C}$
- Pulse test: Pulse width $\leq 80 \mu\text{s}$, Duty cycle $\leq 1\%$
- Switching time measurements performed on LEM TR-58 test equipment.

IRF320-323/IRF720-723
MTP3N35/3N40

T-39-11

Typical Electrical Characteristics

Figure 1 Switching Test Circuit

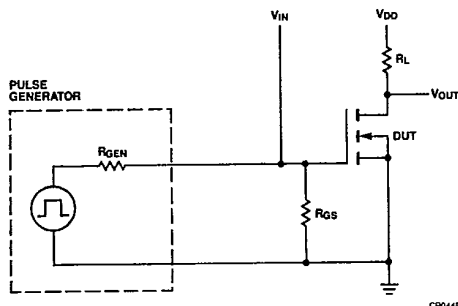
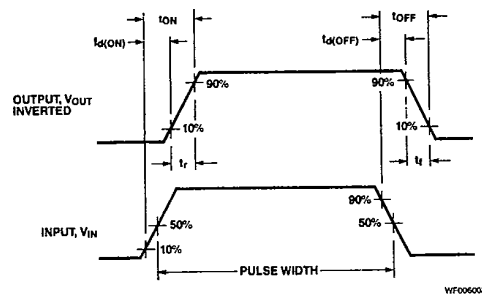

Figure 2 Switching Waveforms



Typical Performance Curves

Figure 3 Output Characteristics

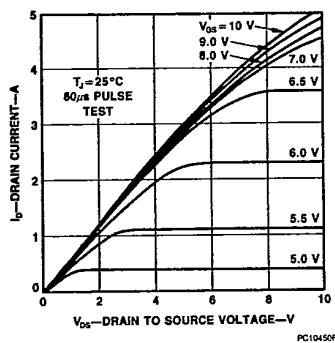

Figure 4 Static Drain to Source Resistance vs Drain Current

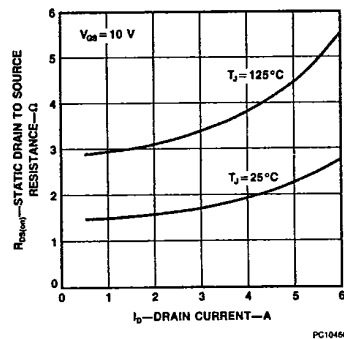

Figure 5 Transfer Characteristics

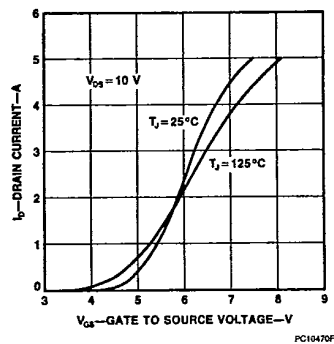
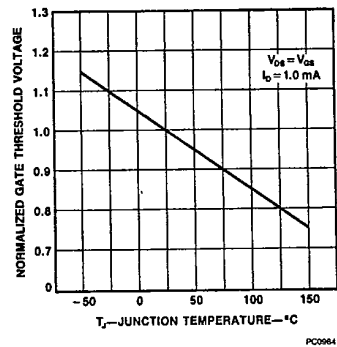

Figure 6 Temperature Variation of Gate to Source Threshold Voltage



IRF320-323/IRF720-723
MTP3N35/3N40

T-39-11

Typical Performance Curves (Cont.)

Figure 7 Capacitance vs Drain to Source Voltage

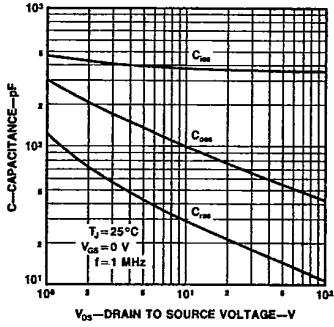

PC10490F

Figure 8 Gate to Source Voltage vs Total Gate Charge

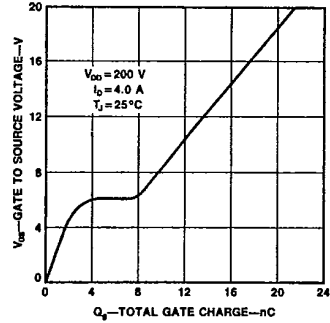

PC10490F

Figure 9 Forward Biased Safe Operating Area for IRF320-323 and IRF720-723

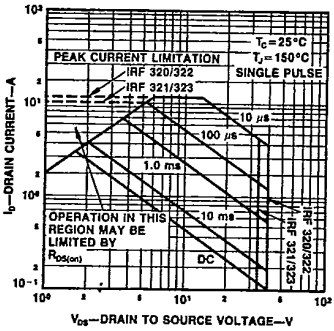

PC10501F

Figure 10 Transient Thermal Resistance vs Time for IRF320-323 and IRF720-723

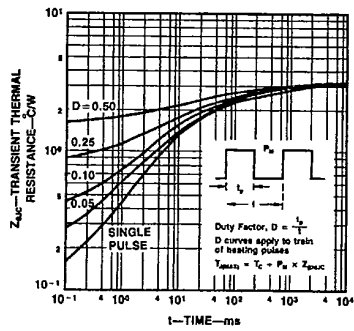

PC09931F

Figure 11 Forward Biased Safe Operating Area for MTP3N35/3N40

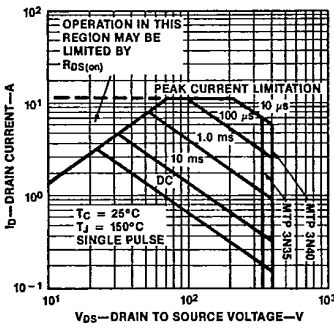

PC10511F

Figure 12 Transient Thermal Resistance vs Time for MTP3N35/3N40

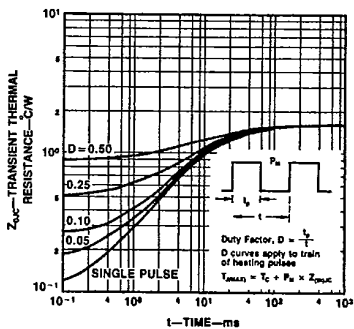

PC09951F

2