

Silicon PIN Photodiode with Enhanced Blue Sensitivity; in SMT Version 1.6

BPW 34 B



Features:

- Especially suitable for applications from 350 nm to 1100 nm
- Short switching time (typ. 25 ns)
- DIL plastic package with high packing density

Applications

- Photointerrupters
- Industrial electronics
- For control and drive circuits

Ordering Information

Type:	Photocurrent	Ordering Code
	I_P [μA] $\lambda = 400 \text{ nm}$, $E_e = 1 \text{ mW/cm}^2$, $V_R = 5 \text{ V}$	
BPW 34 B	14.8 (≥ 10.8)	Q62702P0945

Maximum Ratings ($T_A = 25\text{ °C}$)

Parameter	Symbol	Values	Unit
Operating and storage temperature range	$T_{op}; T_{stg}$	-40 ... 85	°C
Reverse voltage	V_R	32	V
Total Power dissipation	P_{tot}	150	mW
ESD withstand voltage (acc. to ANSI/ ESDA/ JEDEC JS-001 - HBM)	V_{ESD}	2000	V

Characteristics ($T_A = 25\text{ °C}$)

Parameter	Symbol	Values	Unit
Spectral sensitivity ($V_R = 5\text{ V}$, standard light A, $T = 2856\text{ K}$)	(typ) S	75	nA/lx
Photocurrent ($V_R = 5\text{ V}$, $E_e = 1\text{ mW/cm}^2$, $\lambda = 400\text{ nm}$)	(typ (min)) I_P	14.8 (≥ 10.8)	μA
Wavelength of max. sensitivity	(typ) $\lambda_{S\text{ max}}$	850	nm
Spectral range of sensitivity	(typ) $\lambda_{10\%}$	(typ) 350 ... 1100	nm
Radiant sensitive area	(typ) A	7.45	mm^2
Dimensions of radiant sensitive area	(typ) L x W	2.73 x 2.73	mm x mm
Half angle	(typ) φ	± 60	°
Dark current ($V_R = 10\text{ V}$)	(typ (max)) I_R	2 (≤ 30)	nA
Spectral sensitivity of the chip ($\lambda = 400\text{ nm}$)	(typ) $S_{\lambda\text{ typ}}$	0.2	A / W
Quantum yield of the chip ($\lambda = 400\text{ nm}$)	(typ) η	0.62	Electrons / Photon
Open-circuit voltage ($E_v = 1000\text{ lx}$, Std. Light A)	(typ (min)) V_O	390	mV
Short-circuit current ($E_e = 0.5\text{ mW/cm}^2$, $\lambda = 400\text{ nm}$)	(typ) I_{SC}	7.4	μA
Rise and fall time ($V_R = 5\text{ V}$, $R_L = 50\ \Omega$, $\lambda = 850\text{ nm}$)	(typ) t_r, t_f	0.025	μs
Forward voltage ($I_F = 100\text{ mA}$, $E = 0$)	(typ) V_F	1.3	V
Capacitance ($V_R = 0\text{ V}$, $f = 1\text{ MHz}$, $E = 0$)	(typ) C_0	72	pF
Temperature coefficient of V_O	(typ) TC_V	-2.6	mV / K

Parameter		Symbol	Values	Unit
Temperature coefficient of I_{SC} (Std. Light A)	(typ)	TC_1	0.18	% / K
Noise equivalent power ($V_R = 10 \text{ V}$, $\lambda = 400 \text{ nm}$)	(typ)	NEP	0.127	$\text{pW} / \text{Hz}^{1/2}$
Detection limit	(typ)	D^*	2.2×10^{12}	$\text{cm} \times \text{Hz}^{1/2} / \text{W}$

Relative Spectral Sensitivity ^{1) page 7}

$$S_{\text{rel}} = f(\lambda)$$

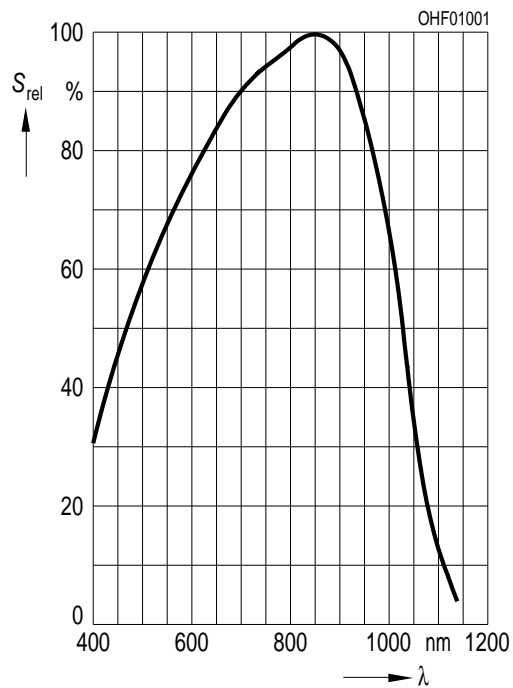

Photocurrent / Open-Circuit Voltage ^{1) page 7}

$$I_P (V_R = 5 \text{ V}) / V_O = f(E_V)$$

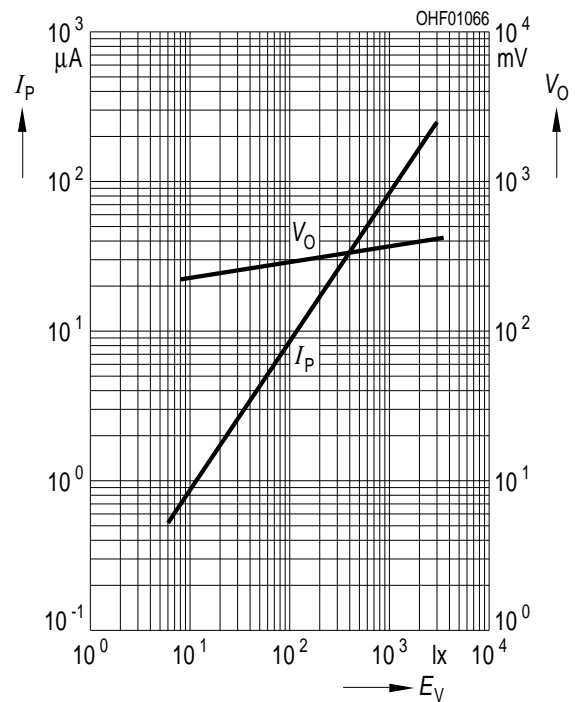

Power Consumption

$P_{tot} = f(T_A)$

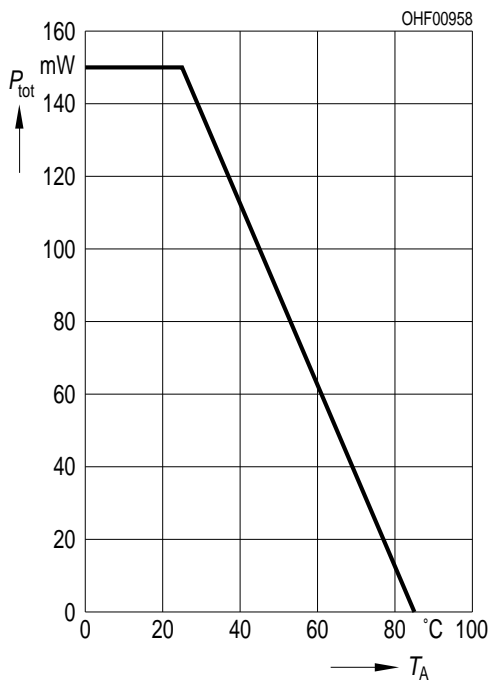

Dark Current ^{1) page 7}

$I_R = f(V_R), E = 0$

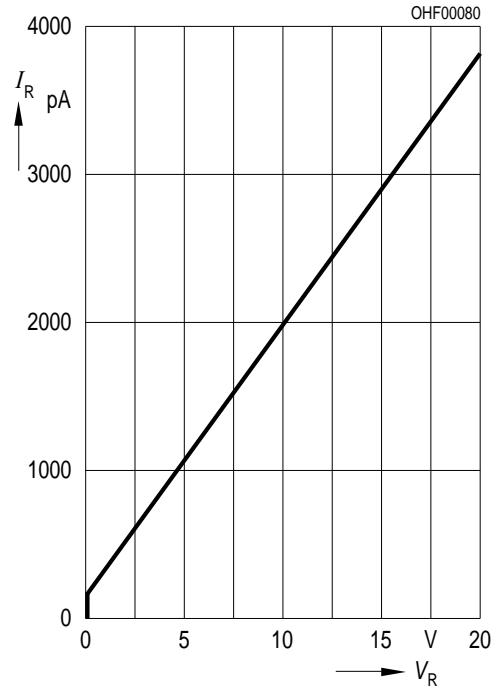

Capacitance ^{1) page 7}

$C = f(V_R), f = 1 \text{ MHz}, E = 0$

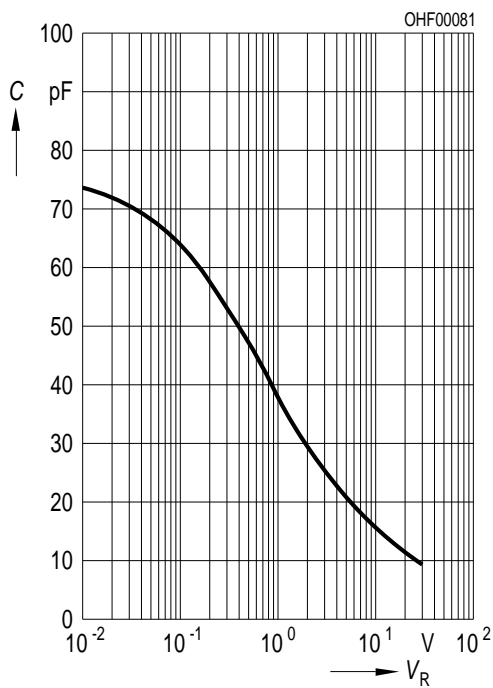

Dark Current ^{1) page 7}

$I_R = f(T_A), V_R = 10 \text{ V}, E = 0$

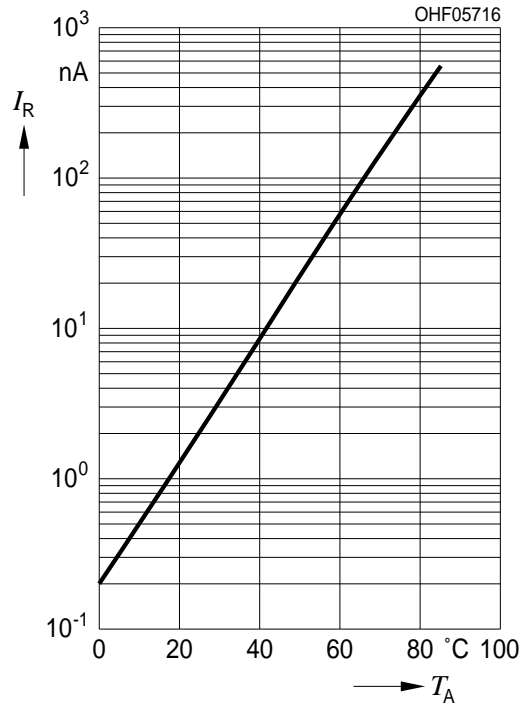

Directional Characteristics ^{1) page 7}

$S_{rel} = f(\phi)$

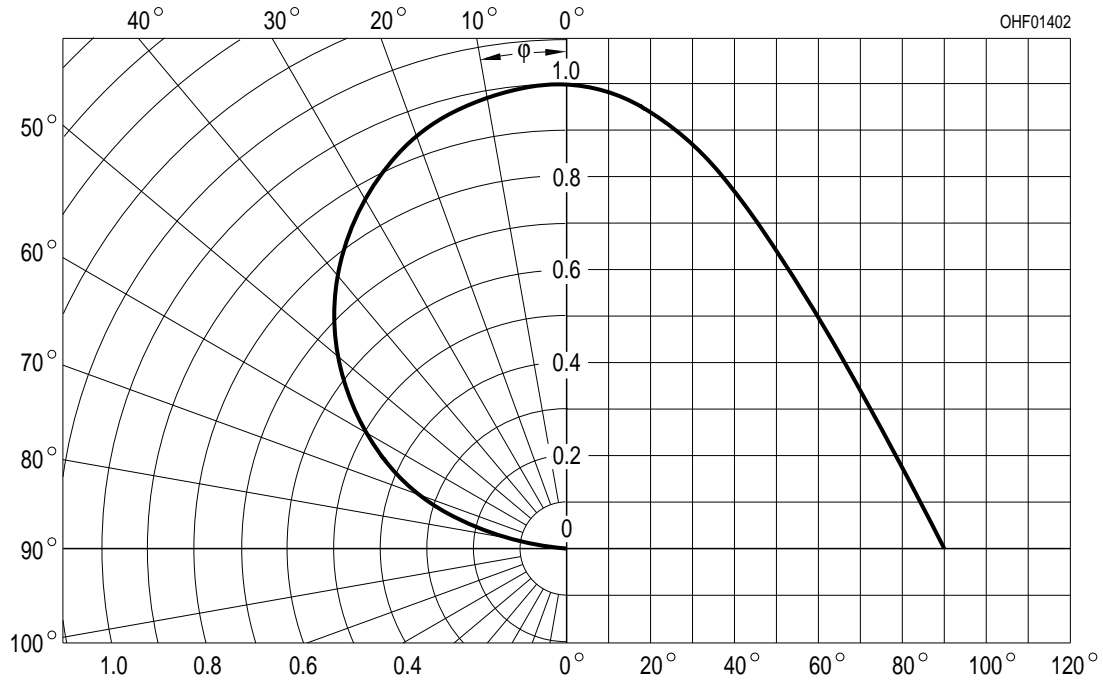

Package Outline

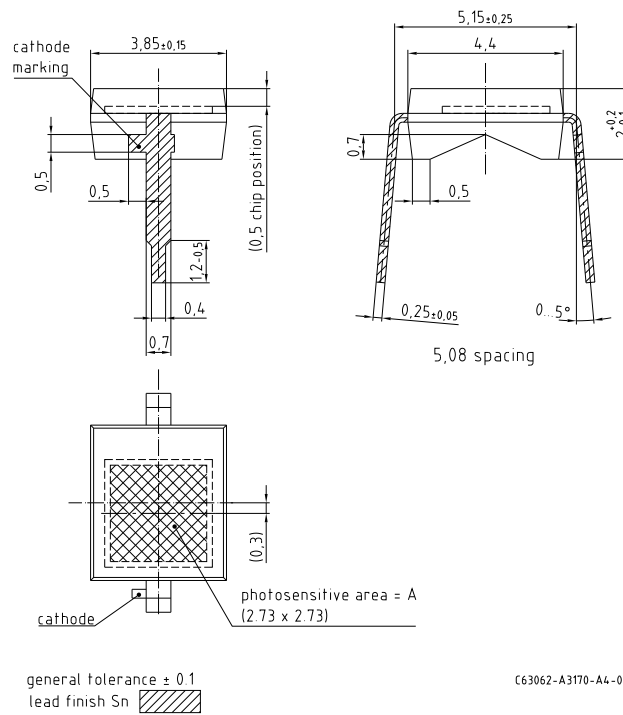

Dimensions in mm.

Package
DIL, Epoxy

Approximate Weight:

78 mg

TTW Soldering

IEC-61760-1 TTW

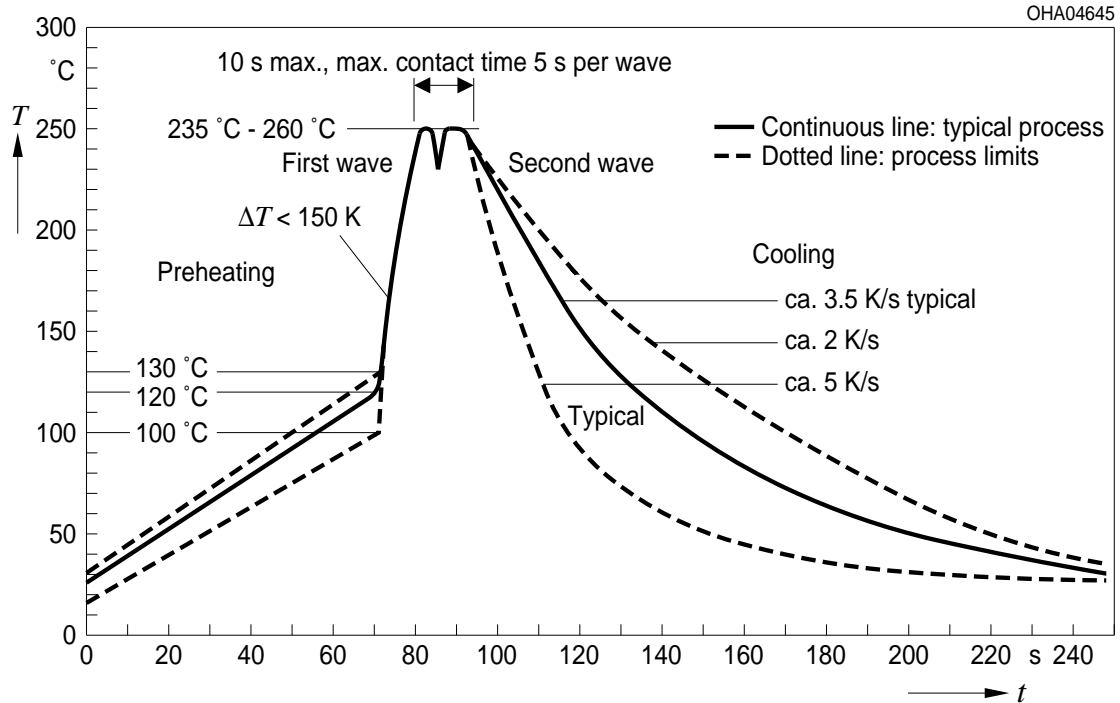
**Disclaimer**

Language english will prevail in case of any discrepancies or deviations between the two language wordings.

Attention please!

The information describes the type of component and shall not be considered as assured characteristics.

Terms of delivery and rights to change design reserved. Due to technical requirements components may contain dangerous substances.

For information on the types in question please contact our Sales Organization.

If printed or downloaded, please find the latest version in the Internet.

Packing

Please use the recycling operators known to you. We can also help you – get in touch with your nearest sales office. By agreement we will take packing material back, if it is sorted. You must bear the costs of transport. For packing material that is returned to us unsorted or which we are not obliged to accept, we shall have to invoice you for any costs incurred.

Components used in life-support devices or systems must be expressly authorized for such purpose!

Critical components* may only be used in life-support devices** or systems with the express written approval of OSRAM OS.

*) A critical component is a component used in a life-support device or system whose failure can reasonably be expected to cause the failure of that life-support device or system, or to affect its safety or the effectiveness of that device or system.

**) Life support devices or systems are intended (a) to be implanted in the human body, or (b) to support and/or maintain and sustain human life. If they fail, it is reasonable to assume that the health and the life of the user may be endangered.

Glossary

- ¹⁾ **Typical Values:** Due to the special conditions of the manufacturing processes of LED, the typical data or calculated correlations of technical parameters can only reflect statistical figures. These do not necessarily correspond to the actual parameters of each single product, which could differ from the typical data and calculated correlations or the typical characteristic line. If requested, e.g. because of technical improvements, these typ. data will be changed without any further notice.

Published by OSRAM Opto Semiconductors GmbH
Leibnizstraße 4, D-93055 Regensburg
www.osram-os.com © All Rights Reserved.

EU RoHS and China RoHS compliant product



此产品符合欧盟 RoHS 指令的要求；
按照中国的相关法规和标准，不含有毒有害物质或元素。