

BATTERY-BACKUP SUPERVISOR FOR RAM RETENTION

FEATURES

- Supply Current of 40 μ A (Max)
- Battery Supply Current of 100 nA (Max)
- Precision 5-V Supply Voltage Monitor, Other Voltage Options on Request
- Backup-Battery Voltage Can Exceed V_{DD}
- Watchdog Timer With 800-ms Time-Out
- Power-On Reset Generator With Fixed 100-ms Reset Delay Time
- Voltage Monitor for Power-Fail or Low-Battery Monitoring
- Battery Freshness Seal (TPS3617 Only)
- 8-Pin MSOP Package
- Temperature Range: -40° to $+85^{\circ}$ C

APPLICATIONS

- Fax Machines
- Set-Top Boxes
- Advanced Voice Mail Systems
- Portable Battery Powered Equipment
- Computer Equipment
- Advanced Modems
- Automotive Systems
- Portable Long-Time Monitoring Equipment
- Point-of-Sale Equipment

DESCRIPTION

The TPS3617 and TPS3618 are battery-backup supervisors that monitor 5 V supplies. They provide a battery-backup function ideal for applications that require data retention of CMOS RAM during fault conditions. When the voltage at V_{DD} drops below a preset threshold (V_{IT}), the active low push-pull $\overline{\text{RESET}}$ output asserts, and V_{OUT} switches from V_{DD} to V_{BAT} . When V_{DD} rises above the trip threshold, V_{OUT} switches immediately from V_{BAT} to V_{DD} . The $\overline{\text{RESET}}$ output remains low until the delay time (t_d) expires. During power on, $\overline{\text{RESET}}$ is asserted when the supply voltage (V_{DD} or V_{BAT}) goes higher than 1.1 V.

The PFI and $\overline{\text{PFO}}$ pins are provided if additional voltage monitoring is needed. If the voltage at PFI is less than 1.15 V, the push-pull $\overline{\text{PFO}}$ pin will assert low. When the voltage at PFI exceeds the threshold voltage, $\overline{\text{PFO}}$ will go high.

These devices also feature a watchdog timer pin ($\overline{\text{WDI}}$) that monitors processor activity and asserts $\overline{\text{RESET}}$ if the the processor is inactive longer than the watchdog timeout period. If the watchdog timer is not used, the $\overline{\text{WDI}}$ pin should be left floating.

The TPS3617 and TPS3618 are available in an 8-pin MSOP package and are characterized for operation over a temperature range of -40° C to $+85^{\circ}$ C.

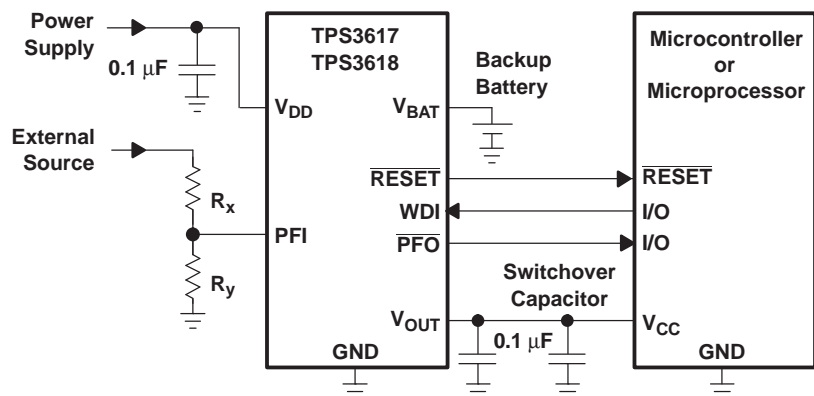
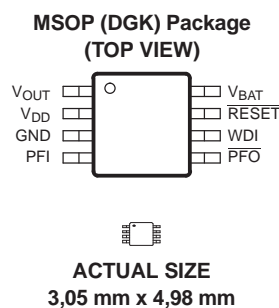

Please be aware that an important notice concerning availability, standard warranty, and use in critical applications of Texas Instruments semiconductor products and disclaimers thereto appears at the end of this data sheet.



This integrated circuit can be damaged by ESD. Texas Instruments recommends that all integrated circuits be handled with appropriate precautions. Failure to observe proper handling and installation procedures can cause damage.

ESD damage can range from subtle performance degradation to complete device failure. Precision integrated circuits may be more susceptible to damage because very small parametric changes could cause the device not to meet its published specifications.

PACKAGE INFORMATION⁽¹⁾

PRODUCT	NOMINAL SUPPLY VOLTAGE	THRESHOLD VOLTAGE (V _{IT}) ⁽²⁾	SPECIFIED TEMPERATURE RANGE	PACKAGE MARKING	ORDERING NUMBER	TRANSPORT MEDIA, QUANTITY
TPS3617-50	5V	4.55V	–40°C to +125°C	ASD	TPS3617-50DGK	Tube, 80
					TPS3617-50DGKR	Tape and Reel, 2500
TPS3618-50				ANK	TPS3618-50DGKT	Tape and Reel, 250
					TPS3618-50DGKR	Tape and Reel, 2500

- (1) For the most current package and ordering information, see the Package Option Addendum at the end of this data sheet, or refer to our web site at www.ti.com.
 (2) For other threshold voltages, contact the local TI sales office for availability and lead time.

ABSOLUTE MAXIMUM RATINGS

over operating free-air temperature (unless otherwise noted)⁽¹⁾

	TPS3617, TPS3618	UNIT
Input voltage range, V _{DD}	–0.3 to 7	V
Input voltage range, PFI pin	–0.3 to (V _{DD} + 0.3)	V
WDI pin	–0.3 to (V _{DD} + 0.3)	V
Continuous output current at V _{OUT} , I _O	400	mA
All other pins, I _O	±10	mA
Operating junction temperature range, T _J ⁽²⁾	–40 to +85	°C
Storage temperature range, T _{STG}	–65 to +150	°C
Lead temperature soldering 1,6 mm (1/16 inch) from case for 10 seconds	+260	°C
Continuous total power dissipation	See Dissipation Rating Table	

- (1) Stresses beyond those listed under *Absolute Maximum Ratings* may cause permanent damage to the device. These are stress ratings only, and functional operation of the device at these or any other conditions beyond those indicated under *Recommended Operating Conditions* is not implied. Exposure to absolute-maximum-rated conditions for extended periods may affect device reliability.
 (2) Due to the low dissipated power in this device, it is assumed that T_J = T_A.

DISSIPATION RATING TABLE

PACKAGE	T _A ≤ +25°C POWER RATING	DERATING FACTOR ABOVE T _A = +25°C	T _A = +70°C POWER RATING	T _A = +85°C POWER RATING
DGK	470 mW	3.76 mW/°C	301 mW	241 mW

ELECTRICAL CHARACTERISTICS

1.65 V ≤ V_{DD} ≤ 5.5 V, R_{LRESET} = 1 MΩ, C_{LRESET} = 50 pF, over operating temperature range (T_J = –40°C to +85°C), unless otherwise noted. Typical values are at T_J = +25°C.

PARAMETER		TEST CONDITIONS	MIN	TYP	MAX	UNIT		
V _{DD}	Input supply range		1.65		5.5	V		
I _{DD}	V _{DD} supply current	V _{OUT} = V _{DD}			40	μA		
		V _{OUT} = V _{BAT}			40			
V _{BAT}	Battery supply range		1.5		5.5	V		
I _{BAT}	V _{BAT} supply current	V _{OUT} = V _{DD}	–0.1		0.1	μA		
		V _{OUT} = V _{BAT}			0.5			
	Slew rate at V _{DD} or V _{BAT}				1	V/μs		
V _I	Input voltage, any input		0		V _{DD} + 0.3	V		
V _{OH}	High-level output voltage	RESET	V _{DD} = 1.8 V, I _{OH} = –400 μA			V _{DD} – 0.2	V	
			V _{DD} = 3.3 V, I _{OH} = –2 mA, V _{DD} = 5 V, I _{OH} = –3 mA			V _{DD} – 0.4		
		PFO	V _{DD} = 1.8 V, I _{OH} = –20 μA			V _{DD} – 0.3		
			V _{DD} = 3.3 V, I _{OH} = –80 μA, V _{DD} = 5 V, I _{OH} = –120 μA			V _{DD} – 0.4		
V _{OL}	Low-level output voltage	RESET PFO	V _{DD} = 1.8 V, I _{OL} = 400 μA			0.2	V	
			V _{DD} = 3.3 V, I _{OL} = 2 mA, V _{DD} = 5 V, I _{OL} = 3 mA			0.4		
			V _{BAT} > 1.1 V, or V _{DD} > 1.1 V, I _{OL} = 20 μA			0.4		
V _{OUT}	Normal mode	I _O = 8.5 mA, V _{DD} = 1.8 V, V _{BAT} = 0 V				V _{DD} – 0.050	V	
		I _O = 125 mA, V _{DD} = 3.3 V, V _{BAT} = 0 V				V _{DD} – 0.150		
		I _O = 200 mA, V _{DD} = 5 V, V _{BAT} = 0 V				V _{DD} – 0.200		
	Battery-backup mode	I _O = 0.5 mA, V _{BAT} = 1.5 V, V _{DD} = 0 V				V _{BAT} – 0.200		
		I _O = 7.5 mA, V _{BAT} = 3.3 V, V _{DD} = 0 V				V _{BAT} – 0.113		
R _{DS(on)}	V _{DD} to V _{OUT} on-resistance	V _{DD} = 5 V			0.6	1	Ω	
	V _{BAT} to V _{OUT} on-resistance	V _{BAT} = 3.3 V			8	15		
I _O	Continuous output current at V _{OUT}					300	mA	
V _{IT}	Negative-going input threshold voltage ⁽²⁾	TPS3617-50	T _A = –40°C to +85°C	4.46	4.55		V	
V _{PFI}		PFI		1.13	1.15	1.17	V	
V _{HYS}	V _{IT} hysteresis	1.65 V < V _{IT} < 2.5 V				20	mV	
		2.5 V < V _{IT} < 3.5 V				40		
		3.5 V < V _{IT} < 5.5 V				60		
	PFI hysteresis				12			
	V _{BSW} hysteresis ⁽³⁾	V _{DD} = 1.8 V				55		
V _{IH}	WDI high-level input voltage				0.7 x V _{DD}			
V _{IL}	WDI low-level input voltage				0.3 x V _{DD}			
I _{IH}	WDI high-level input current ⁽⁴⁾	WDI = V _{DD} = 5 V				150	μA	
I _{IL}	WDI low-level input current ⁽⁴⁾	WDI = 0 V, V _{DD} = 5 V				–150	μA	
	WDI input transition rise and fall rate, Δt/ΔV					100	ns/V	
I _I	PFI input current	PFI voltage < V _{DD}				–25	25	nA
I _{OS}	PFO short-circuit current	PFO = 0 V, V _{DD} = 1.8 V				–0.3	mA	
		PFO = 0 V, V _{DD} = 3.3 V				–1.1		
		PFO = 0 V, V _{DD} = 5 V				–2.4		

(1) The lowest supply voltage at which RESET becomes active. t_r, V_{DD} ≥ 15 μs/V.

(2) To ensure the best stability of the threshold voltage, a bypass capacitor (ceramic, 0.1 μF) should be placed near the supply terminals.

(3) For V_{DD} < 1.6 V, V_{OUT} switches to V_{BAT} regardless of V_{BAT}.

(4) For details on how to optimize current consumption when using WDI, refer to the [Watchdog](#) section of this data sheet.

ELECTRICAL CHARACTERISTICS (continued)

1.65 V ≤ V_{DD} ≤ 5.5 V, R_{LRESET} = 1 MΩ, C_{LRESET} = 50 pF, over operating temperature range (T_J = –40°C to +85°C), unless otherwise noted. Typical values are at T_J = +25°C.

PARAMETER		TEST CONDITIONS	MIN	TYP	MAX	UNIT
C _i	Input capacitance, any input	V _I = 0 V to 5 V		5		pF
t _w	Pulse Width	V _{DD}	V _{IH} = V _{IT} + 0.2 V, V _{IL} = V _{IT} – 0.2 V	6		μs
		WDI	V _{DD} > V _{IT} + 0.2 V, V _{IL} = 0.3 × V _{DD} , V _{IH} = 0.7 × V _{DD}	100		ns
t _d	Delay time	V _{DD} ≥ V _{IT} + 0.2 V, See timing diagram	60	100	140	ms
t _(tout)	Watchdog time-out	V _{DD} > V _{IT} + 0.2 V, See timing diagram	0.48	0.8	1.12	s
t _{PHL}	Propagation (delay) time, high-to-low-level output	V _{DD} to $\overline{\text{RESET}}$	V _{IL} = V _{IT} – 0.2 V, V _{IH} = V _{IT} + 0.2 V	2	5	μs
		PFI to $\overline{\text{PFO}}$	V _{IL} = V _{PFI} – 0.2 V, V _{IH} = V _{PFI} + 0.2 V	3	5	
Transition time		V _{DD} to V _{BAT}			3	μs

TIMING DIAGRAM

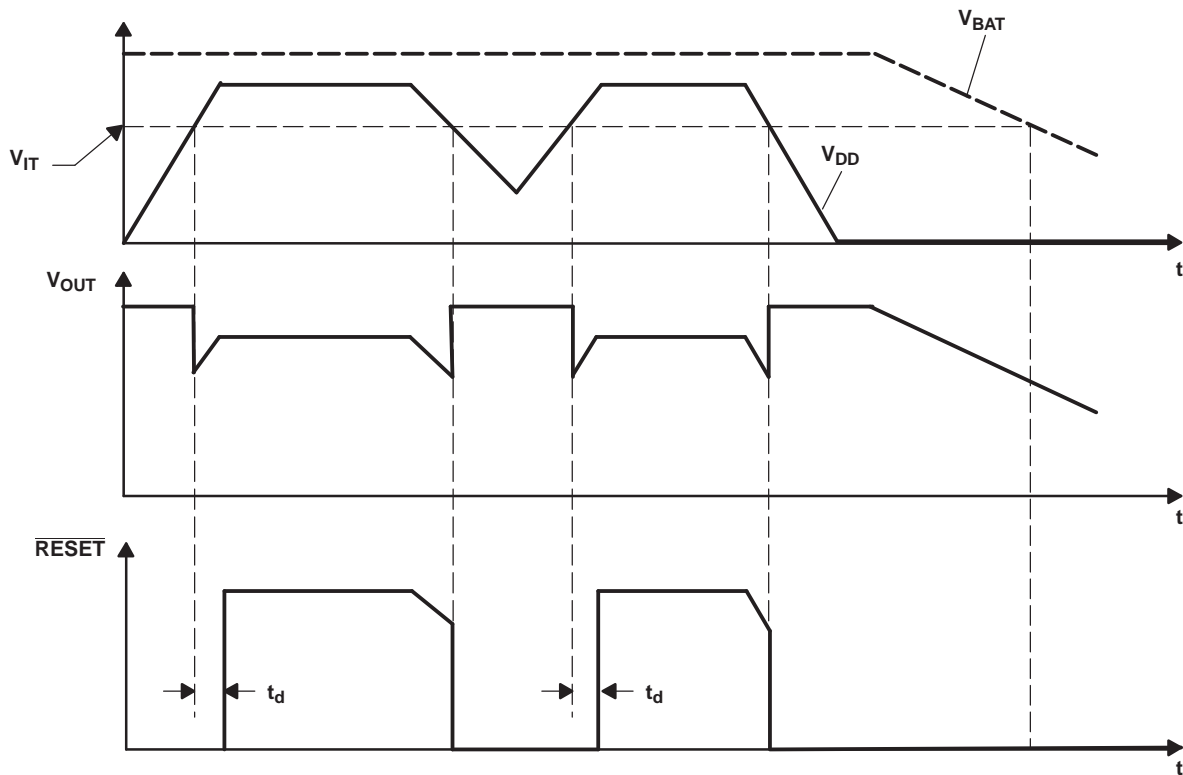

Table 1. FUNCTION TABLE

V _{DD} > V _{IT}	V _{DD} > V _{BAT}	V _{OUT}	RESET
0	0	V _{BAT}	0
0	1	V _{DD}	0
1	0	V _{DD}	1
1	1	V _{DD}	1

Table 2. $\overline{\text{PFO}}$ FUNCTION TABLE

$\text{PFI} > \text{V}_{\text{PFI}}$	$\overline{\text{PFO}}$
0	0
1	1

CONDITION: $\text{V}_{\text{DD}} > \text{V}_{\text{DD}(\text{MIN})}$

Table 3. TERMINAL FUNCTIONS

TERMINAL NAME	NO.	I/O	DESCRIPTION
GND	3	I	Ground
PFI	4	I	Power-fail comparator input
$\overline{\text{PFO}}$	5	O	Power-fail comparator output; asserts low when $\text{PFI} < 1.15 \text{ V}$
$\overline{\text{RESET}}$	7	O	Active-low push-pull reset output
V_{BAT}	8	I	Backup-battery input
V_{DD}	2	I	Input supply voltage
V_{OUT}	1	O	Supply output
WDI	6	I	Watchdog input. Should be left floating if not used.

FUNCTIONAL BLOCK DIAGRAM

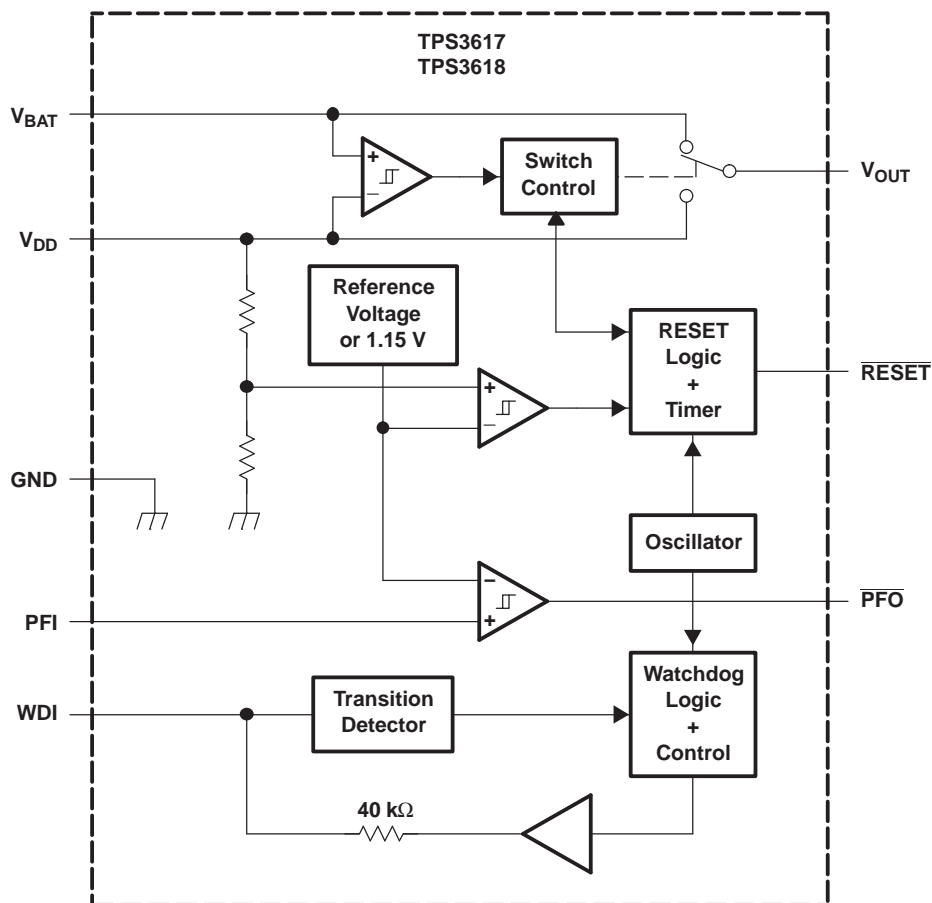

TYPICAL CHARACTERISTICS

TABLE OF GRAPHS

			FIGURE
$r_{DS(on)}$	Static drain-source on-state resistance (V_{DD} to V_{OUT})	vs Output current	3
	Static drain-source on-state resistance (V_{BAT} to V_{OUT})	vs Output current	4
I_{DD}	Supply current	vs Supply voltage	5
V_{IT}	Input threshold voltage at \overline{RESET}	vs Free-air temperature	6
V_{OH}	High-level output voltage at \overline{RESET}	vs High-level output current	7, 8
	High-level output voltage at \overline{PFO}		9, 10
V_{OL}	Low-level output voltage at \overline{RESET}	vs Low-level output current	11, 12
	Minimum pulse duration at V_{DD}	vs Threshold voltage overdrive at V_{DD}	13
	Minimum pulse duration at PFI	vs Threshold voltage overdrive at PFI	14

STATIC DRAIN-SOURCE ON-STATE RESISTANCE
(V_{DD} to V_{OUT})
vs
OUTPUT CURRENT

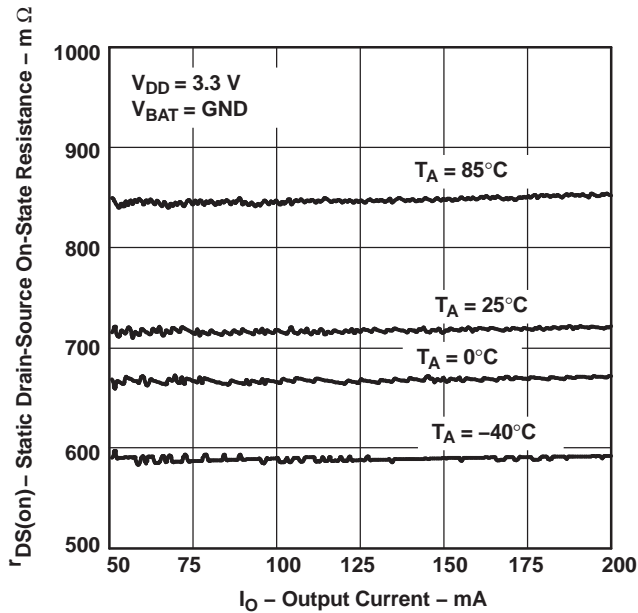

Figure 1.

STATIC DRAIN-SOURCE ON-STATE RESISTANCE
(V_{BAT} to V_{OUT})
vs
OUTPUT CURRENT

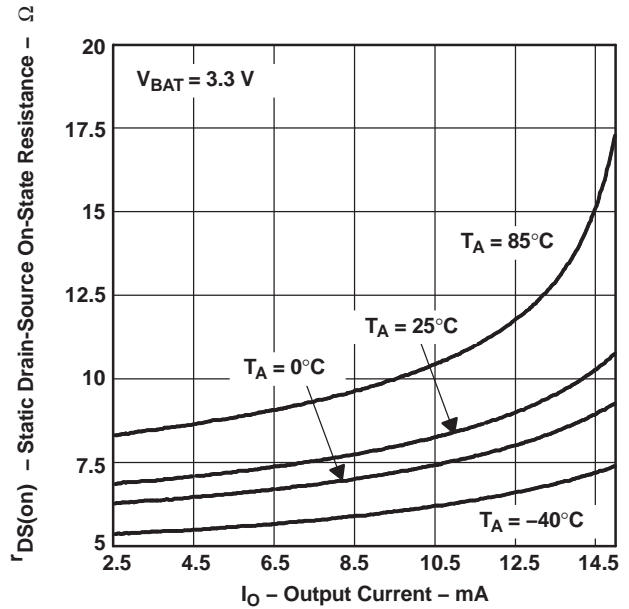

Figure 2.

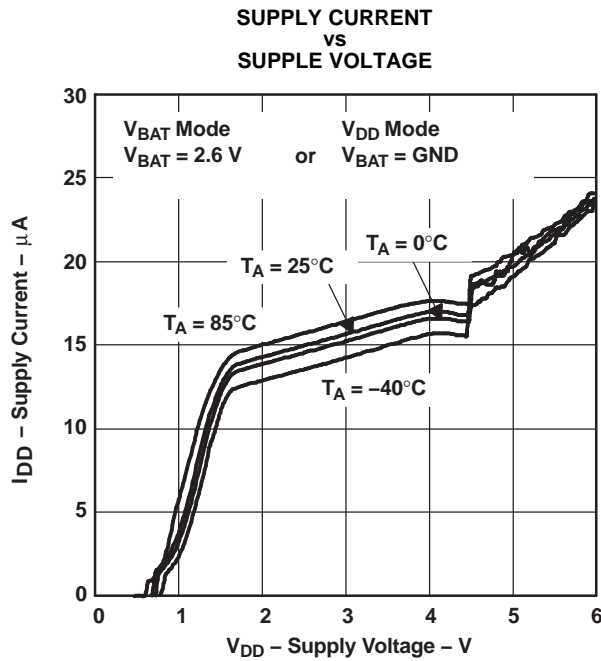

Figure 3.

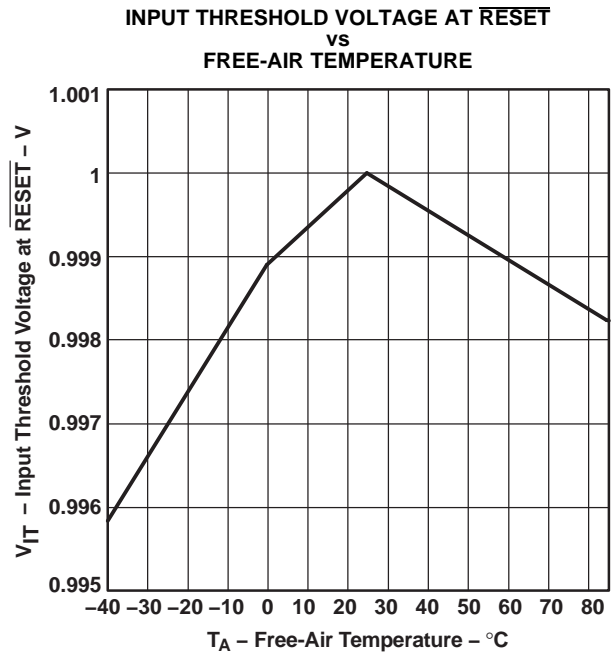

Figure 4.

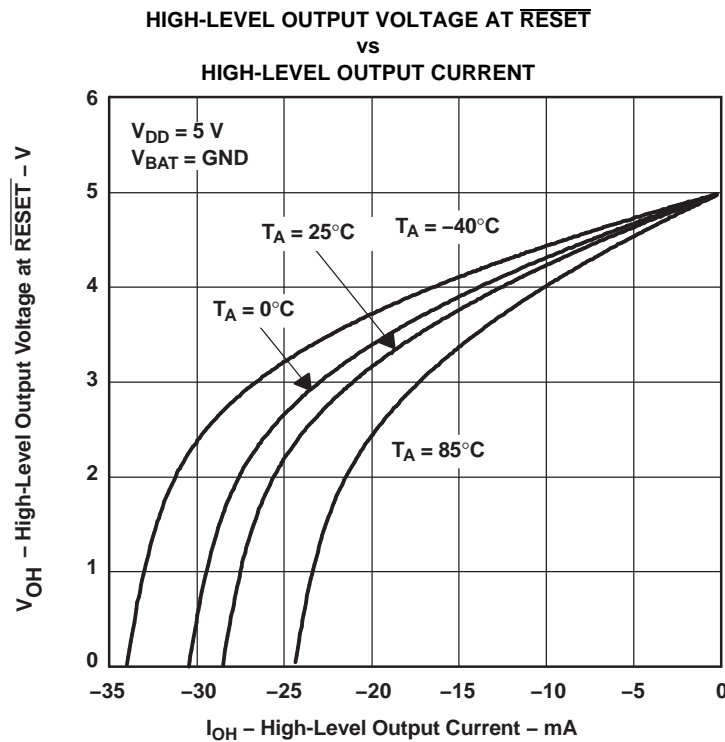

Figure 5.

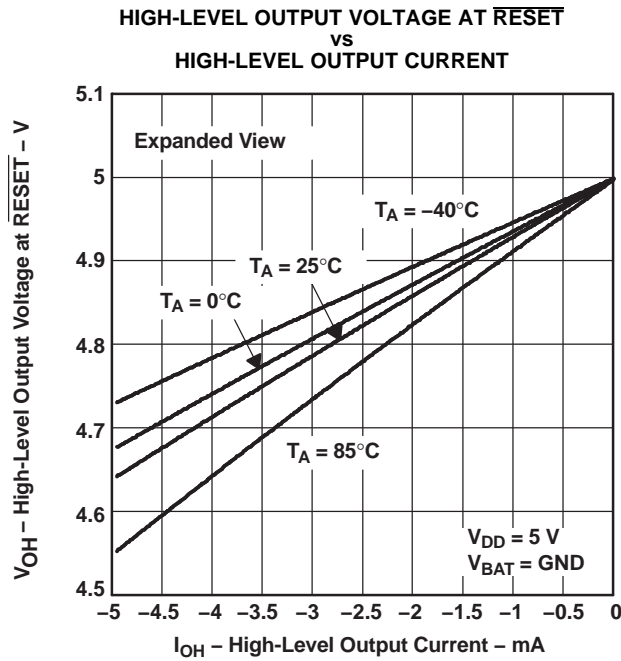

Figure 6.

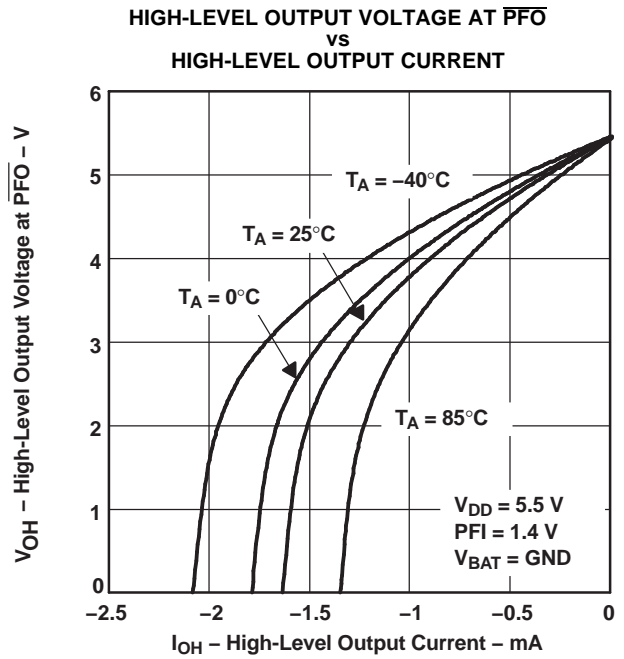

Figure 7.

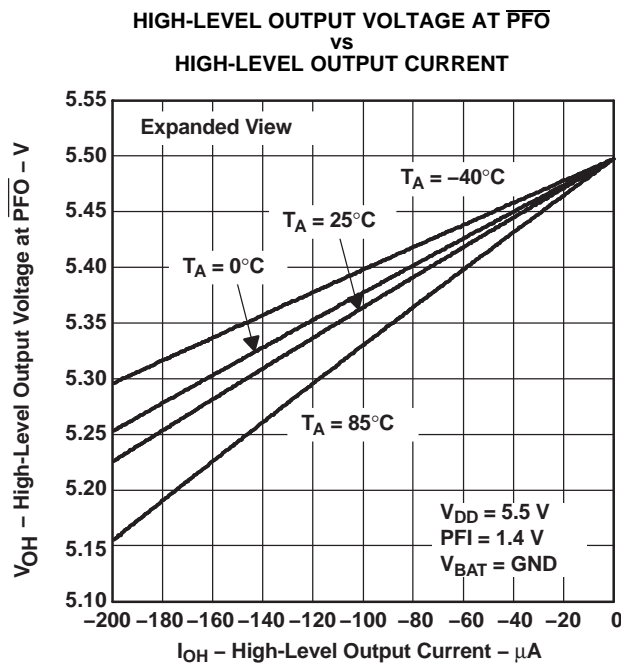

Figure 8.

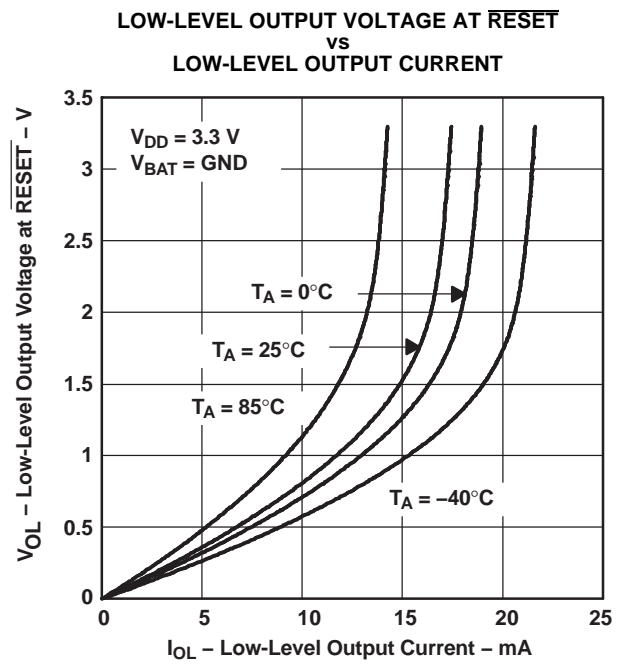

Figure 9.

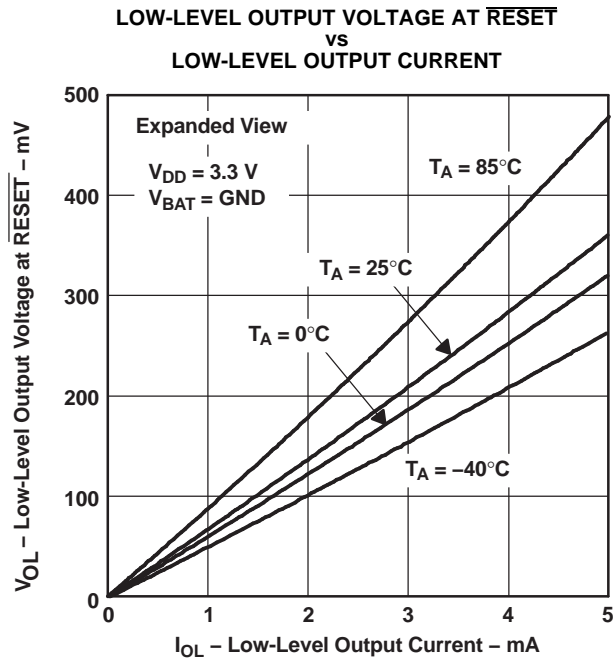

Figure 10.

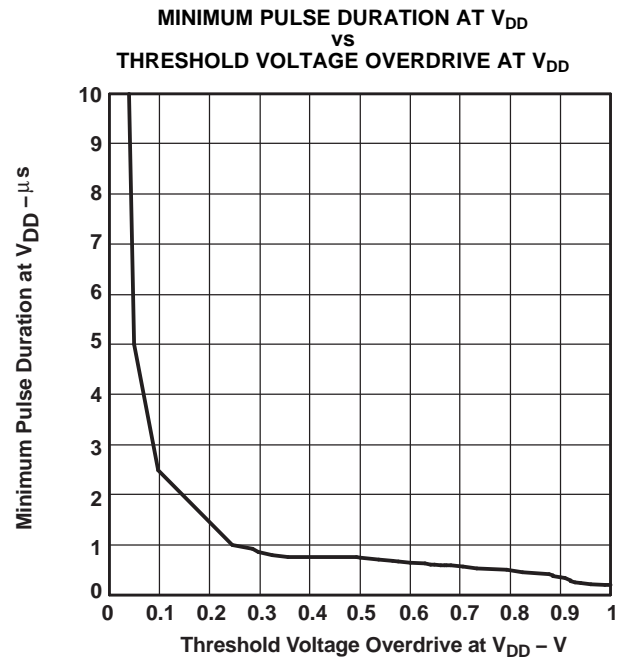

Figure 11.

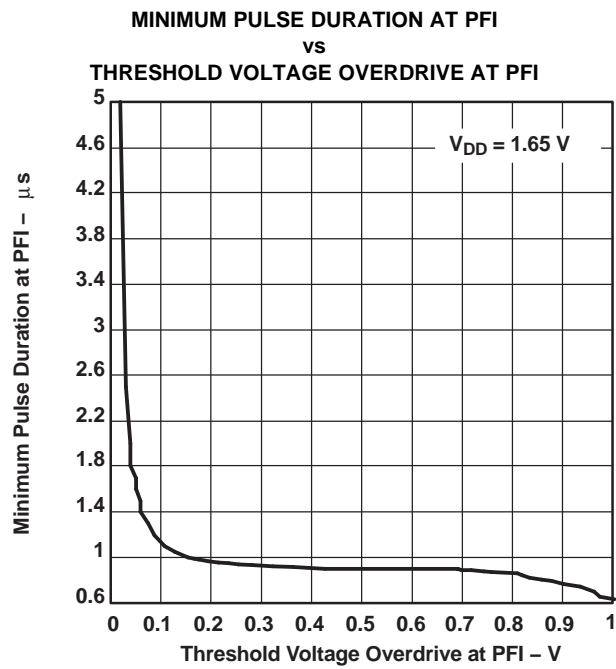

Figure 12.

DETAILED DESCRIPTION

BATTERY FRESHNESS SEAL (TPS3617 Only)

The battery freshness seal of the TPS3617 family disconnects the backup battery from the internal circuitry until it is needed. This ensures that the backup battery connected to V_{BAT} should be fresh when the final product is put to use. The following steps explain how to enable the freshness seal mode:

1. Connect V_{BAT} ($V_{BAT} > V_{BAT(min)}$).
2. Ground \overline{PFO} .
3. Connect PFI to V_{DD} ($PFI = V_{DD}$).
4. Connect V_{DD} to power supply ($V_{DD} > V_{IT}$) and keep connected for $5 \text{ ms} < t < 35 \text{ ms}$.

The battery freshness seal mode is disabled by the positive-going edge of \overline{RESET} when V_{DD} is applied.

POWER-FAIL COMPARATOR (PFI AND \overline{PFO})

An additional comparator monitors voltages other than the nominal supply voltage. The power-fail-input (PFI) can be compared with an internal voltage reference of 1.15 V. If the input voltage falls below the power-fail threshold ($V_{(PFI)}$) of 1.15 V typical, the power-fail output (\overline{PFO}) goes low. If it goes above $V_{(PFI)}$ plus about 12-mV hysteresis, the output returns to high. By connecting two external resistors it is possible to supervise any voltages above $V_{(PFI)}$. The sum of both resistors should be about 1 M Ω , to minimize power consumption and also to ensure that the current in the PFI pin can be neglected compared with the current through the resistor network. The tolerance of the external resistors should be not more than 1% to ensure minimal variation of the sensed voltage. If the power-fail comparator is unused, connect PFI to ground and leave the \overline{PFO} unconnected.

WATCHDOG

In a microprocessor- or DSP-based system, it is not only important to supervise the supply voltage, it is also important to ensure correct program execution. The task of a watchdog is to ensure that the program is not stalled in an indefinite loop. The microprocessor, microcontroller, or DSP has to toggle the watchdog input within 0.8 s typically, to avoid a timeout from occurring. Either a low-to-high or a high-to-low transition resets the internal watchdog timer. If the input is unconnected, the watchdog is disabled and should be retriggered internally. See Figure 13 for the watchdog timing diagram.

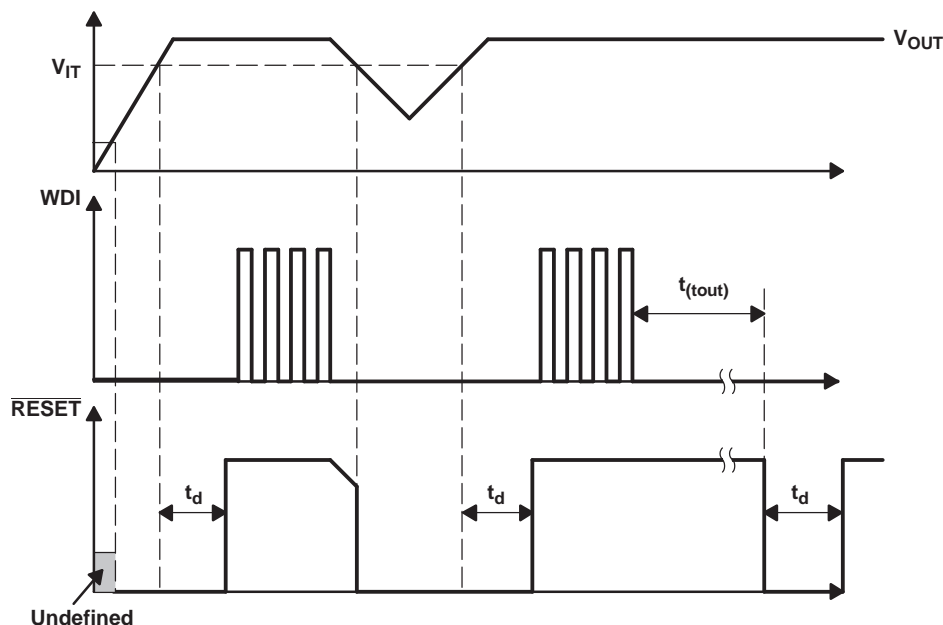

Figure 13. Watchdog Timing

DETAILED DESCRIPTION (continued)

SAVING CURRENT WHILE USING THE WATCHDOG

The watchdog input is internally driven low during the first 7/8 of the watchdog time-out period, then momentarily pulses high, resetting the watchdog counter. For minimum watchdog input current (minimum overall power consumption), leave WDI low for the majority of the watchdog time-out period, pulsing it low-high-low once within 7/8 of the watchdog time-out period to reset the watchdog timer. If instead, WDI is externally driven high for the majority of the time-out period, a current of e.g. $5.0 \text{ V}/40 \text{ k}\Omega \approx 125 \mu\text{A}$ can flow into WDI.

BACKUP-BATTERY SWITCHOVER

In case of a brownout or power failure, it may be necessary to preserve the contents of RAM. If a backup battery is installed at V_{BAT} , the device automatically switches the connected RAM to backup power when V_{DD} fails. In order to allow the backup battery (e.g., a 3.6-V lithium cell) to have a higher voltage than V_{DD} , these supervisors should not connect V_{BAT} to V_{OUT} when V_{BAT} is greater than V_{DD} . V_{BAT} only connects to V_{OUT} (through a 15- Ω switch) when V_{DD} falls below V_{IT} and V_{BAT} is greater than V_{DD} . When V_{DD} recovers, switchover is deferred either until V_{DD} crosses V_{BAT} , or until V_{DD} rises above the reset threshold V_{IT} . V_{OUT} connects to V_{DD} through a 1- Ω (max) PMOS switch when V_{DD} crosses the reset threshold.

FUNCTION TABLE		
$V_{\text{DD}} > V_{\text{BAT}}$	$V_{\text{DD}} > V_{\text{IT}}$	V_{OUT}
1	1	V_{DD}
1	0	V_{DD}
0	1	V_{DD}
0	0	V_{BAT}

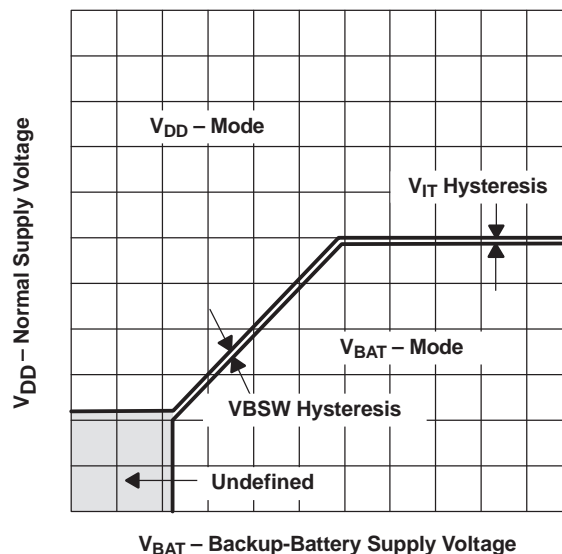

Figure 14. $V_{\text{DD}} - V_{\text{BAT}}$ Switchover

PACKAGING INFORMATION

Orderable Device	Status (1)	Package Type	Package Drawing	Pins	Package Qty	Eco Plan (2)	Lead/Ball Finish (6)	MSL Peak Temp (3)	Op Temp (°C)	Device Marking (4/5)	Samples
TPS3617-50DGK	ACTIVE	VSSOP	DGK	8	80	Green (RoHS & no Sb/Br)	CU NIPDAU	Level-1-260C-UNLIM	-40 to 85	ASD	Samples
TPS3617-50DGKG4	ACTIVE	VSSOP	DGK	8	80	Green (RoHS & no Sb/Br)	CU NIPDAU	Level-1-260C-UNLIM	-40 to 85	ASD	Samples
TPS3617-50DGKR	ACTIVE	VSSOP	DGK	8	2500	Green (RoHS & no Sb/Br)	CU NIPDAU	Level-1-260C-UNLIM	-40 to 85	ASD	Samples
TPS3618-50DGKT	ACTIVE	VSSOP	DGK	8	250	Green (RoHS & no Sb/Br)	CU NIPDAU	Level-1-260C-UNLIM	-40 to 125	ANK	Samples

(1) The marketing status values are defined as follows:

ACTIVE: Product device recommended for new designs.

LIFEBUY: TI has announced that the device will be discontinued, and a lifetime-buy period is in effect.

NRND: Not recommended for new designs. Device is in production to support existing customers, but TI does not recommend using this part in a new design.

PREVIEW: Device has been announced but is not in production. Samples may or may not be available.

OBSELETE: TI has discontinued the production of the device.

(2) Eco Plan - The planned eco-friendly classification: Pb-Free (RoHS), Pb-Free (RoHS Exempt), or Green (RoHS & no Sb/Br) - please check <http://www.ti.com/productcontent> for the latest availability information and additional product content details.

TBD: The Pb-Free/Green conversion plan has not been defined.

Pb-Free (RoHS): TI's terms "Lead-Free" or "Pb-Free" mean semiconductor products that are compatible with the current RoHS requirements for all 6 substances, including the requirement that lead not exceed 0.1% by weight in homogeneous materials. Where designed to be soldered at high temperatures, TI Pb-Free products are suitable for use in specified lead-free processes.

Pb-Free (RoHS Exempt): This component has a RoHS exemption for either 1) lead-based flip-chip solder bumps used between the die and package, or 2) lead-based die adhesive used between the die and leadframe. The component is otherwise considered Pb-Free (RoHS compatible) as defined above.

Green (RoHS & no Sb/Br): TI defines "Green" to mean Pb-Free (RoHS compatible), and free of Bromine (Br) and Antimony (Sb) based flame retardants (Br or Sb do not exceed 0.1% by weight in homogeneous material)

(3) MSL, Peak Temp. - The Moisture Sensitivity Level rating according to the JEDEC industry standard classifications, and peak solder temperature.

(4) There may be additional marking, which relates to the logo, the lot trace code information, or the environmental category on the device.

(5) Multiple Device Markings will be inside parentheses. Only one Device Marking contained in parentheses and separated by a "~" will appear on a device. If a line is indented then it is a continuation of the previous line and the two combined represent the entire Device Marking for that device.

(6) Lead/Ball Finish - Orderable Devices may have multiple material finish options. Finish options are separated by a vertical ruled line. Lead/Ball Finish values may wrap to two lines if the finish value exceeds the maximum column width.

Important Information and Disclaimer: The information provided on this page represents TI's knowledge and belief as of the date that it is provided. TI bases its knowledge and belief on information provided by third parties, and makes no representation or warranty as to the accuracy of such information. Efforts are underway to better integrate information from third parties. TI has taken and continues to take reasonable steps to provide representative and accurate information but may not have conducted destructive testing or chemical analysis on incoming materials and chemicals. TI and TI suppliers consider certain information to be proprietary, and thus CAS numbers and other limited information may not be available for release.

In no event shall TI's liability arising out of such information exceed the total purchase price of the TI part(s) at issue in this document sold by TI to Customer on an annual basis.

TAPE AND REEL INFORMATION
REEL DIMENSIONS

TAPE DIMENSIONS

A0	Dimension designed to accommodate the component width
B0	Dimension designed to accommodate the component length
K0	Dimension designed to accommodate the component thickness
W	Overall width of the carrier tape
P1	Pitch between successive cavity centers

TAPE AND REEL INFORMATION

*All dimensions are nominal

Device	Package Type	Package Drawing	Pins	SPQ	Reel Diameter (mm)	Reel Width W1 (mm)	A0 (mm)	B0 (mm)	K0 (mm)	P1 (mm)	W (mm)	Pin1 Quadrant
TPS3617-50DGKR	VSSOP	DGK	8	2500	330.0	12.4	5.3	3.4	1.4	8.0	12.0	Q1
TPS3618-50DGKT	VSSOP	DGK	8	250	177.8	12.4	5.3	3.4	1.4	8.0	12.0	Q1

TAPE AND REEL BOX DIMENSIONS

*All dimensions are nominal

Device	Package Type	Package Drawing	Pins	SPQ	Length (mm)	Width (mm)	Height (mm)
TPS3617-50DGKR	VSSOP	DGK	8	2500	358.0	335.0	35.0
TPS3618-50DGKT	VSSOP	DGK	8	250	358.0	335.0	35.0

DGK (S-PDSO-G8)

PLASTIC SMALL-OUTLINE PACKAGE



4073329/E 05/06

- NOTES:
- A. All linear dimensions are in millimeters.
 - B. This drawing is subject to change without notice.
 - C. Body length does not include mold flash, protrusions, or gate burrs. Mold flash, protrusions, or gate burrs shall not exceed 0.15 per end.
 - D. Body width does not include interlead flash. Interlead flash shall not exceed 0.50 per side.
 - E. Falls within JEDEC MO-187 variation AA, except interlead flash.

IMPORTANT NOTICE

Texas Instruments Incorporated and its subsidiaries (TI) reserve the right to make corrections, enhancements, improvements and other changes to its semiconductor products and services per JESD46, latest issue, and to discontinue any product or service per JESD48, latest issue. Buyers should obtain the latest relevant information before placing orders and should verify that such information is current and complete. All semiconductor products (also referred to herein as "components") are sold subject to TI's terms and conditions of sale supplied at the time of order acknowledgment.

TI warrants performance of its components to the specifications applicable at the time of sale, in accordance with the warranty in TI's terms and conditions of sale of semiconductor products. Testing and other quality control techniques are used to the extent TI deems necessary to support this warranty. Except where mandated by applicable law, testing of all parameters of each component is not necessarily performed.

TI assumes no liability for applications assistance or the design of Buyers' products. Buyers are responsible for their products and applications using TI components. To minimize the risks associated with Buyers' products and applications, Buyers should provide adequate design and operating safeguards.

TI does not warrant or represent that any license, either express or implied, is granted under any patent right, copyright, mask work right, or other intellectual property right relating to any combination, machine, or process in which TI components or services are used. Information published by TI regarding third-party products or services does not constitute a license to use such products or services or a warranty or endorsement thereof. Use of such information may require a license from a third party under the patents or other intellectual property of the third party, or a license from TI under the patents or other intellectual property of TI.

Reproduction of significant portions of TI information in TI data books or data sheets is permissible only if reproduction is without alteration and is accompanied by all associated warranties, conditions, limitations, and notices. TI is not responsible or liable for such altered documentation. Information of third parties may be subject to additional restrictions.

Resale of TI components or services with statements different from or beyond the parameters stated by TI for that component or service voids all express and any implied warranties for the associated TI component or service and is an unfair and deceptive business practice. TI is not responsible or liable for any such statements.

Buyer acknowledges and agrees that it is solely responsible for compliance with all legal, regulatory and safety-related requirements concerning its products, and any use of TI components in its applications, notwithstanding any applications-related information or support that may be provided by TI. Buyer represents and agrees that it has all the necessary expertise to create and implement safeguards which anticipate dangerous consequences of failures, monitor failures and their consequences, lessen the likelihood of failures that might cause harm and take appropriate remedial actions. Buyer will fully indemnify TI and its representatives against any damages arising out of the use of any TI components in safety-critical applications.

In some cases, TI components may be promoted specifically to facilitate safety-related applications. With such components, TI's goal is to help enable customers to design and create their own end-product solutions that meet applicable functional safety standards and requirements. Nonetheless, such components are subject to these terms.

No TI components are authorized for use in FDA Class III (or similar life-critical medical equipment) unless authorized officers of the parties have executed a special agreement specifically governing such use.

Only those TI components which TI has specifically designated as military grade or "enhanced plastic" are designed and intended for use in military/aerospace applications or environments. Buyer acknowledges and agrees that any military or aerospace use of TI components which have **not** been so designated is solely at the Buyer's risk, and that Buyer is solely responsible for compliance with all legal and regulatory requirements in connection with such use.

TI has specifically designated certain components as meeting ISO/TS16949 requirements, mainly for automotive use. In any case of use of non-designated products, TI will not be responsible for any failure to meet ISO/TS16949.

Products

Audio	www.ti.com/audio
Amplifiers	amplifier.ti.com
Data Converters	dataconverter.ti.com
DLP® Products	www.dlp.com
DSP	dsp.ti.com
Clocks and Timers	www.ti.com/clocks
Interface	interface.ti.com
Logic	logic.ti.com
Power Mgmt	power.ti.com
Microcontrollers	microcontroller.ti.com
RFID	www.ti-rfid.com
OMAP Applications Processors	www.ti.com/omap
Wireless Connectivity	www.ti.com/wirelessconnectivity

Applications

Automotive and Transportation	www.ti.com/automotive
Communications and Telecom	www.ti.com/communications
Computers and Peripherals	www.ti.com/computers
Consumer Electronics	www.ti.com/consumer-apps
Energy and Lighting	www.ti.com/energy
Industrial	www.ti.com/industrial
Medical	www.ti.com/medical
Security	www.ti.com/security
Space, Avionics and Defense	www.ti.com/space-avionics-defense
Video and Imaging	www.ti.com/video

TI E2E Community

e2e.ti.com