

POWR-GARD® Fuse

KLKD SERIES 10 X 38

600 V ac/dc • Fast Acting • 1/10–30 A



Description

The KLKD fuse series is fast-acting with a high dc voltage rating. This family of midget-style fuses (10 x 38 mm) is used in solar combiner boxes and in circuits with dc fault currents up to 50,000 amperes. KLKD fuses are available in standard and board-mount configurations.

In addition, the KLKD series has been designed to meet both the UL and IEC photovoltaic fuse standards.

Littelfuse offers a wide range of ampere ratings to match specific requirements in a variety of applications.

Features/Benefits

- Designed to UL and IEC photovoltaic specifications
- 1/10–30 ampere ratings available
- 50,000 amperes interrupting rating
- Available in ferrule or PCB mount options
- 1–5 ampere meets UL 1741 GFDI requirements

Applications

- Combiner boxes and inverters
- Power supplies
- Desktop meters

Recommended Fuse Holders (Ferrule Fuse)

Littelfuse LPSM dead-front series
Littelfuse L60030M open-face series

Web Resources

Download CAD drawings and other technical information:
Littelfuse.com/KLKD

Specifications

Voltage Rating	600 V ac/V dc
Amperage Ratings	1/10 – 30 A
Interrupting Ratings	Ac: 100 kA 200 kA Littelfuse self-certified Dc: 1/10–30: 10 kA (UL 248-19) 1/10–30: 50 kA (UL 248-14)
Material	Body: melamine / Caps: copper alloy
Operating Temperature Approvals*	See derating curve UL Listed (File: E339112 and E10480) VDE Certified (No. 40033094) CSA Certified (File: LR29862)
Applicable Standards	UL 248-14, UL 248-19, UL 1741 GFDI, CSA, IEC 60269-6
Environmental Country of Origin	RoHS compliant Mexico

*Refer to Ordering Information Table

Dimensions Inches (mm)

Ferrule Version

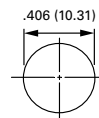
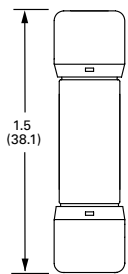

PCB 1-Tab

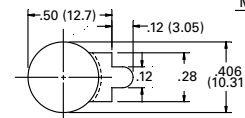
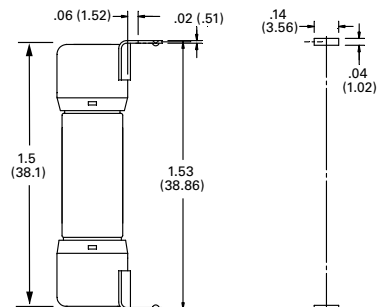

MOUNTING HOLE
DETAIL

POWR-GARD® Fuse

KLKD SERIES 10 X 38

Ordering Information (Ferrule Version)

SERIES	AMPERAGE RATING	CATALOG NUMBER	PRODUCT MARKING	PACKING QUANTITY	ORDERING NUMBER	UPC CODE	AGENCY APPROVALS		
							UL	VDE	CSA
KLKD	1/10	KLKD.100	KLKD 1/10A	10	KLKD.100T	07945810189	•		•
				100	KLKD.100H	07945896442			
KLKD	1/8	KLKD.125	KLKD 1/8A	10	KLKD.200T	07945810190	•		•
				100	KLKD.200H	07945896443			
KLKD	2/10	KLKD.200	KLKD 2/10A	10	KLKD.100T	07945810191	•		•
				100	KLKD.100H	07945896444			
KLKD	1/4	KLKD.250	KLKD ¼A	10	KLKD.250T	07945810192	•		•
				100	KLKD.250H	07945896445			
KLKD	3/10	KLKD.300	KLKD 3/10A	10	KLKD.300T	07945810193	•		•
				100	KLKD.300H	07945896446			
KLKD	1/2	KLKD.500	KLKD ½A	10	KLKD.500T	07945810194	•		•
				100	KLKD.500H	07945896447			
KLKD	3/4	KLKD.750	KLKD ¾A	10	KLKD.750T	07945810195	•		•
				100	KLKD.750H	07945896448			
KLKD	1	KLKD001	KLKD 1A	10	KLKD001.T	07945810196	•		•
				100	KLKD001.H	07945896449			
KLKD	1 1/2	KLKD01.5	KLKD 1-½A	10	KLKD01.5T	07945810197	•		•
				100	KLKD01.5H	07945896450			
KLKD	2	KLKD002	KLKD 2A	10	KLKD002.T	07945810198	•	•	•
				100	KLKD002.H	07945896451			
KLKD	2 1/2	KLKD02.5	KLKD 2-½A	10	KLKD02.5T	07945810199	•	•	•
				100	KLKD02.5H	07945896452			
KLKD	3	KLKD003	KLKD 3A	10	KLKD003.T	07945810200	•	•	•
				100	KLKD003.H	07945896453			
KLKD	3 1/2	KLKD03.5	KLKD 3-½A	10	KLKD03.5T	07945810214	•	•	•
				100	KLKD03.5H	07945896454			
KLKD	4	KLKD004	KLKD 4A	10	KLKD004.T	07945810201	•	•	•
				100	KLKD004.H	07945896455			
KLKD	5	KLKD005	KLKD 5A	10	KLKD005.T	07945810202	•	•	•
				100	KLKD005.H	07945896456			
KLKD	6	KLKD006	KLKD 6A	10	KLKD006.T	07945810203	•	•	•
				100	KLKD006.H	07945896457			
KLKD	7	KLKD007	KLKD 7A	10	KLKD007.T	07945810204	•	•	•
				100	KLKD007.H	07945896458			
KLKD	8	KLKD008	KLKD 8A	10	KLKD008.T	07945810205	•	•	•
				100	KLKD008.H	07945896459			
KLKD	9	KLKD009	KLKD 9A	10	KLKD009.T	07945810215	•	•	•
				100	KLKD009.H	07945896460			
KLKD	10	KLKD010	KLKD 10A	10	KLKD010.T	07945810206	•	•	•
				100	KLKD010.H	07945896461			
KLKD	12	KLKD012	KLKD 12A	10	KLKD012.T	07945810207	•	•	•
				100	KLKD012.H	07945896462			
KLKD	15	KLKD015	KLKD 15A	10	KLKD015.T	07945810208	•	•	•
				100	KLKD015.H	07945896463			
KLKD	20	KLKD020	KLKD 20A	10	KLKD020.T	07945810209	•	•	•
				100	KLKD020.H	07945896464			
KLKD	25	KLKD025	KLKD 25A	10	KLKD025.T	07945810210	•		•
				100	KLKD025.H	07945896465			
KLKD	30	KLKD030	KLKD 30A	10	KLKD030.T	07945810211	•		•
				100	KLKD030.H	07945896466			

POWR-GARD® Fuse

KLKD SERIES 10 X 38

Ordering Information (PCB 1-Tab Version)

SERIES	AMPERAGE RATING	CATALOG NUMBER	PRODUCT MARKING	PACKING QUANTITY	ORDERING NUMBER	UPC CODE	APPROVALS	
							UL	CSA
KLKD	1/10	KLKD.100R	KLKD 1/10A-R	100	KLKD.100HXR	07945814857	•	•
KLKD	1/2	KLKD.500R	KLKD ½A-R	100	KLKD500.HXR	07945814858	•	•
KLKD	1	KLKD001R	KLKD 1A-R	100	KLKD001.HXR	07945812133	•	•
KLKD	2	KLKD002R	KLKD 2A-R	100	KLKD002.HXR	07945894349	•	•
KLKD	3	KLKD003R	KLKD 3A-R	100	KLKD003.HXR	07945818991	•	•
KLKD	4	KLKD004R	KLKD 4A-R	100	KLKD004.HXR	07945811495	•	•
KLKD	5	KLKD005R	KLKD 5A-R	100	KLKD005.HXR	07945814859	•	•
KLKD	6	KLKD006R	KLKD 6A-R	100	KLKD006.HXR	07945894350	•	•
KLKD	8	KLKD008R	KLKD 8A-R	100	KLKD008.HXR	07945894351	•	•
KLKD	10	KLKD010R	KLKD 10A-R	100	KLKD010.HXR	07945814860	•	•
KLKD	12	KLKD012R	KLKD 12A-R	100	KLKD012.HXR	07945894352	•	•
KLKD	15	KLKD015R	KLKD 15A-R	100	KLKD015.HXR	07945894353	•	•
KLKD	20	KLKD020R	KLKD 20A-R	100	KLKD020.HXR	07945894354	•	•
KLKD	25	KLKD025R	KLKD 25A-R	100	KLKD025.HXR	07945894355	•	•
KLKD	30	KLKD030R	KLKD 30A-R	100	KLKD030.HXR	07945894356	•	•

Electrical Specifications

AMP RATING	CATALOG NUMBER		VOLTAGE		INTERRUPTING RATING (KA)		NOM COLD RESISTANCE (OHMS)	WATTS LOSS AT 100 % RATED CURRENT (W)	WATTS LOSS AT 80 % RATED CURRENT (W)	AVERAGE MELTING I ² t (A ² s)	TOTAL CLEARING I ² t (A ² s) 20 KA @ 600 V DC	TOTAL CLEARING I ² t (A ² s) 100 KA @ 600 V DC
	FERRULE	PCB	AC	DC	AC	DC						
1/10	KLKD.100	KLKD.100R	600	600	200	50	85.5	0.780	0.505	–	0.019	–
1/8	KLKD.125	–	600	600	200	50	65	0.975	0.659	–	0.010	–
2/10	KLKD.200	–	600	600	200	50	30.9	1.213	0.773	–	0.032	–
1/4	KLKD.250	–	600	600	200	50	22	1.364	0.870	–	–	–
3/10	KLKD.300	–	600	600	200	50	16.2	1.519	0.960	–	0.067	–
1/2	KLKD.500	KLKD.500R	600	600	200	50	8.16	1.961	1.237	–	0.197	–
3/4	KLKD.750	–	600	600	200	50	0.402	0.361	1.990	0.234	0.754	–
1	KLKD001	KLKD001R	600	600	200	50	0.252	0.388	0.273	0.678	1.827	0.008
1 1/2	KLKD01.5	–	600	600	200	50	0.134	0.409	0.229	2.890	–	–
2	KLKD002	KLKD002R	600	600	200	50	0.129	0.823	0.606	2.379	3.919	0.012
2 1/2	KLKD02.5	–	600	600	200	50	0.0989	0.912	0.618	5.142	8.877	–
3	KLKD003	KLKD003R	600	600	200	50	0.0773	0.957	0.654	7.821	14.835	–
3 1/2	KLKD03.5	–	600	600	200	50	0.0613	1.120	0.826	12.417	21.048	–
4	KLKD004	KLKD004R	600	600	200	50	0.0511	1.367	0.891	18.945	30.760	0.019
5	KLKD005	KLKD005R	600	600	200	50	0.0363	1.400	0.938	34.163	56.514	0.024
6	KLKD006	KLKD006R	600	600	200	50	0.0261	1.516	0.998	62.951	96.824	0.035
7	KLKD007	–	600	600	200	50	0.0205	1.577	1.066	105.143	168.578	0.087
8	KLKD008	KLKD008R	600	600	200	50	0.0194	1.824	1.205	130.266	210.595	0.656
9	KLKD009	–	600	600	200	50	0.0166	2.208	1.428	164.221	266.633	–
10	KLKD010	KLKD010R	600	600	200	50	0.0128	1.893	1.300	278.390	454.628	211.667
12	KLKD012	KLKD012R	600	600	200	50	0.0103	2.296	1.584	445.010	744.775	440
15	KLKD015	KLKD015R	600	600	200	50	0.007855	2.045	1.570	137.333	351.240	–
20	KLKD020	KLKD020R	600	600	200	50	0.0045	2.133	15.930	462.056	1151.185	2120
25	KLKD025	KLKD025R	600	600	200	50	0.003532	2.550	1.933	834.529	1744.033	2085
30	KLKD030	KLKD030R	600	600	200	50	0.002776	3.701	1.983	1409	2757	3220

Current-Limiting Effects

SHORT CIRCUIT CURRENT*	APPARENT RMS SYMMETRICAL CURRENT FOR VARIOUS FUSE RATINGS			
	1 ½ A	12 A	25 A	30 A
5,000	240	292	654	722
10,000	303	367	823	910
15,000	347	420	943	1042
20,000	381	463	1037	1147
25,000	411	498	1117	1235
30,000	437	530	1188	1313
35,000	460	558	1250	1382
40,000	481	583	1307	1445
50,000	518	628	1408	1556
60,000	550	667	1496	1654
80,000	605	735	1647	1820
100,000	652	791	1774	1961

*Prospective RMS Symmetrical Amperes Short-Circuit Current

Electrical Specification – Agency Requirements

AMPERAGE RATING	OPENING TIME (MINUTES)				
	100 % of Ampere Rating per UL	113 % of Ampere Rating per IEC	135 % of Ampere Rating per UL	145 % of Ampere Rating per IEC	200 % of Ampere Rating per UL
1/10–30	Temperature Stabilization	60 min	60 max	60 max	4 max

Temperature Derating Curve (temperature of air immediately surrounding fuse)

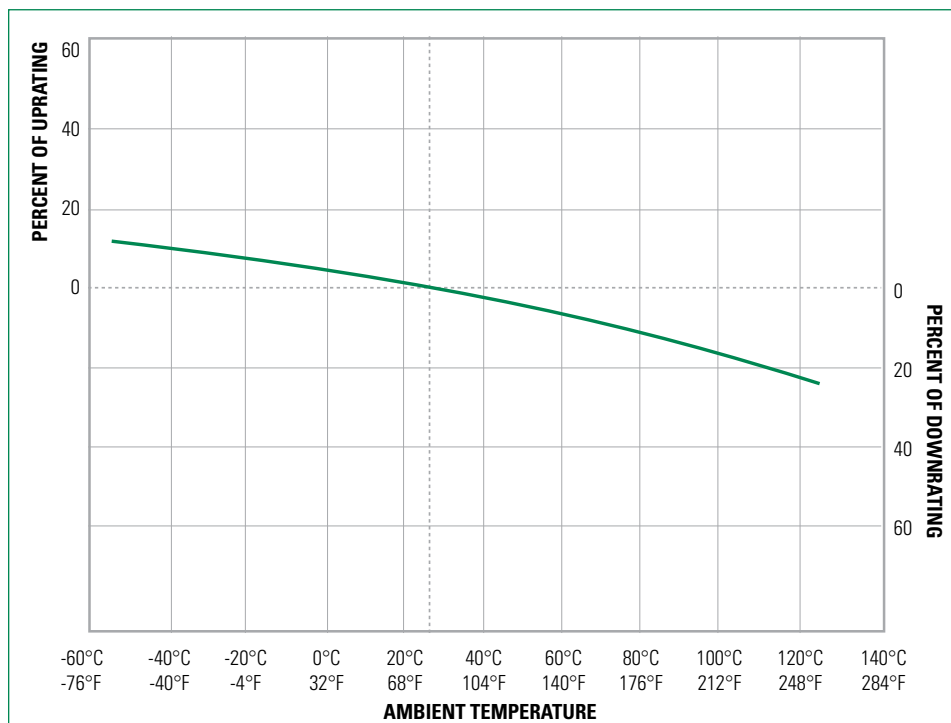

Recommended Process and Soldering Parameters

WAVE PARAMETER	LEAD FREE RECOMMENDATION
Preheat:	(Typical Industry Recommendation)
Temperature Minimum:	130 °C
Temperature Maximum:	—
Pre-heat Time	75 Seconds Maximum
Solder Pot Temperature	280 °C Maximum
Solder Dwell Time	270 °C for 8 Seconds Maximum
Complete Cycle Time	250 Seconds Maximum

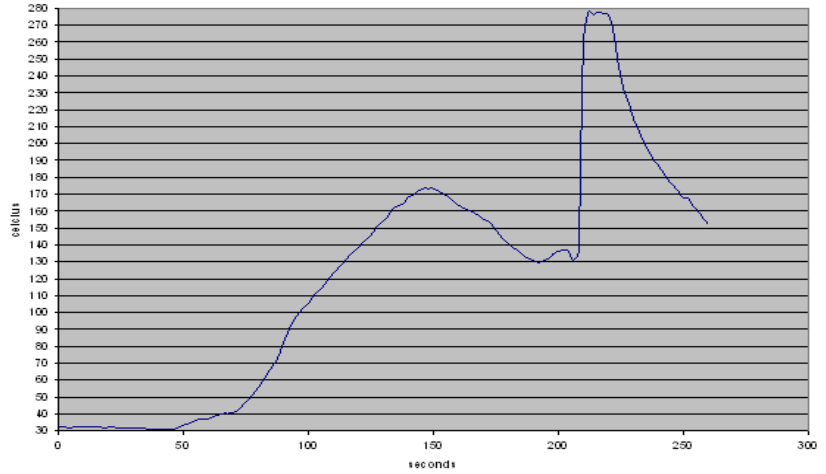

Peak Let Thru Curve

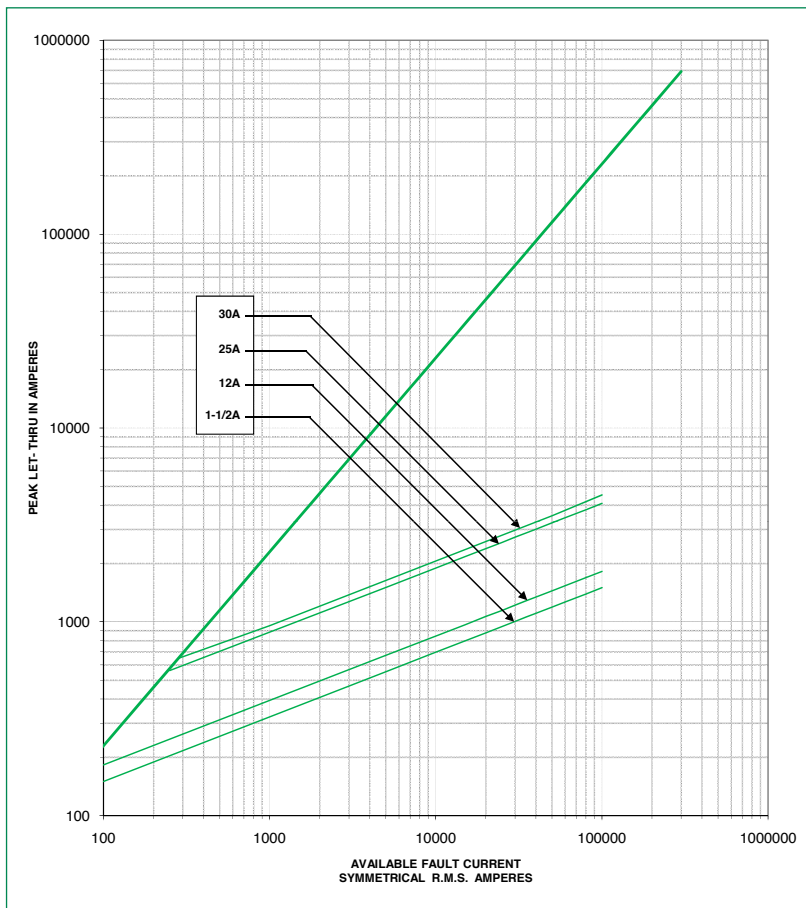

Time Current Curve (1/8–2 1/2 A)

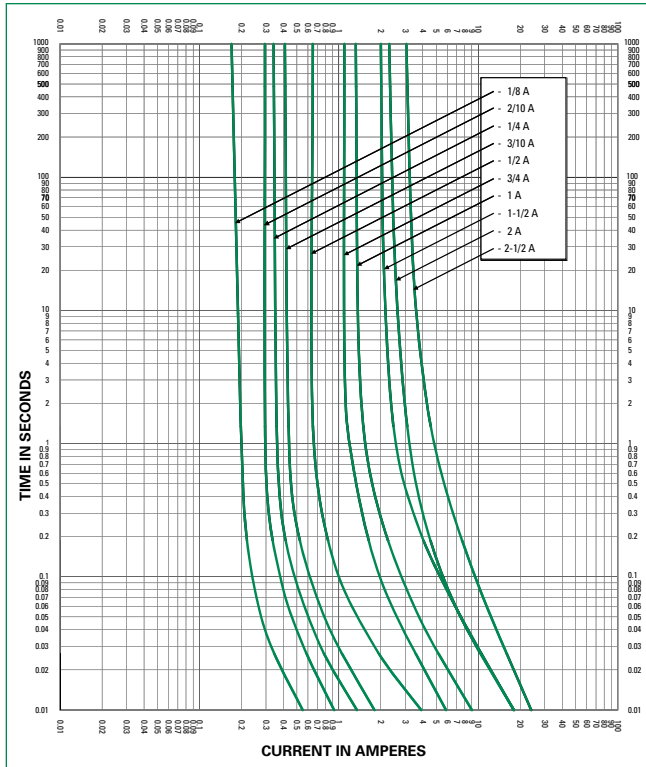

Time Current Curve (3–12 A)

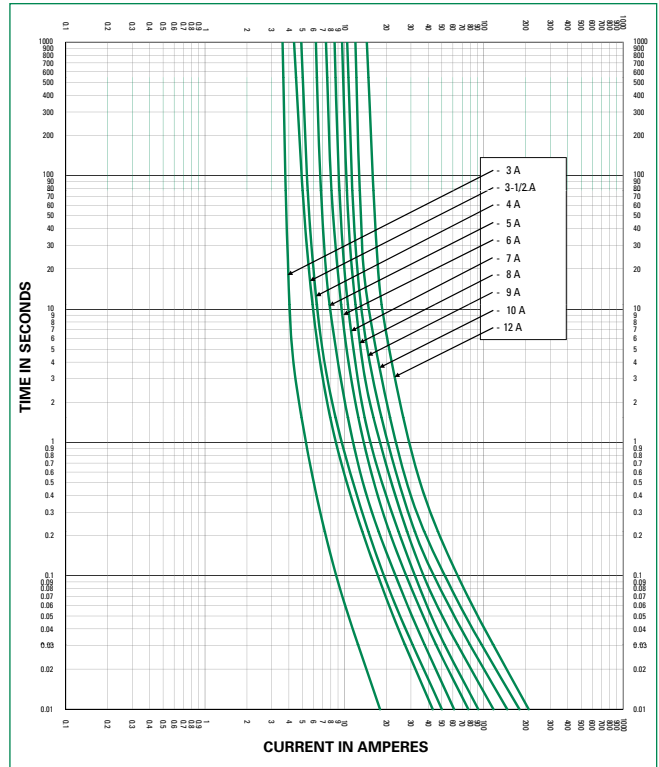

Time Current Curve (15–25 A)

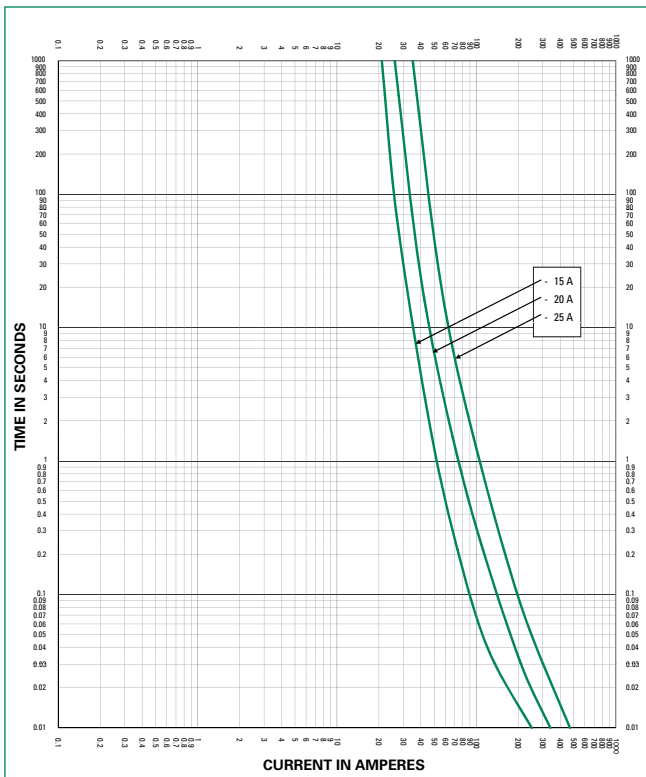

Time Current Curve (30 A)

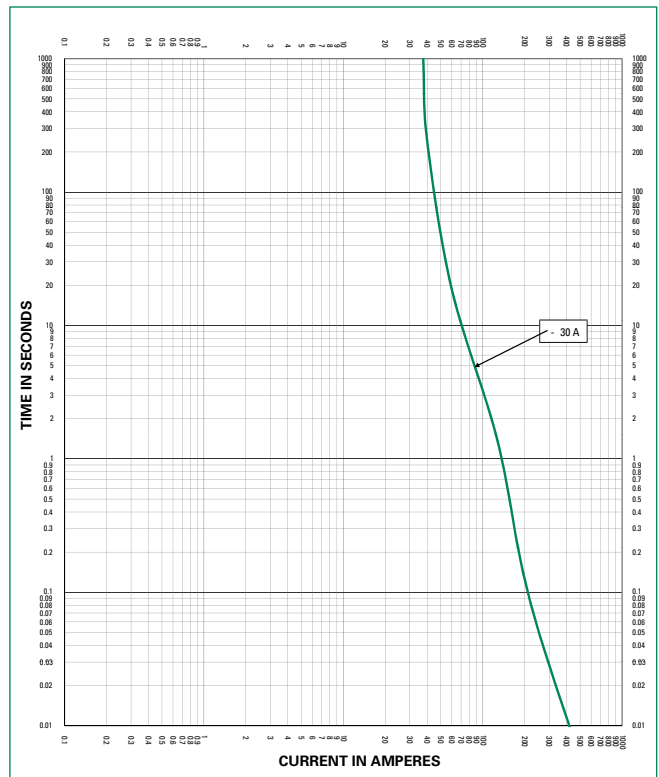

Disclaimer Notice – Information furnished is believed to be accurate and reliable. However, users should independently evaluate the suitability of and test each product selected for their own applications. Littelfuse products are not designed for, and may not be used in, all applications. Read complete Disclaimer Notice at www.littelfuse.com/product-disclaimer.