

FEATURES

- Epitaxial planar die construction.
- Complementary PNP type available (MMBT3906).
- Collector Current Capability $I_{CM} = 200\text{mA}$.
- Collector-emitter Voltage $V_{CEO} = 40\text{V}$.
- MSL 1

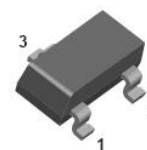

SOT-23

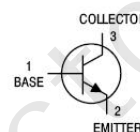

APPLICATIONS

- General switching and amplification

ORDERING INFORMATION

Type No.	Marking	Package Code
MMBT3904	1AM	SOT-23

MAXIMUM RATING @ $T_a = 25^\circ\text{C}$ unless otherwise specified

SYMBOL	PARAMETER	CONDITIONS	Value	UNIT
V_{CBO}	collector-base voltage	open emitter	60	V
V_{CEO}	collector-emitter voltage	open base	40	V
V_{EBO}	emitter-base voltage	open collector	6	V
I_C	collector current (DC)		200	mA
I_{CM}	peak collector current		200	mA
I_{BM}	peak base current		100	mA
P_{tot}	total power dissipation	$T_{amb} \leq 25^\circ\text{C}$	250	mW
T_{stg}	storage temperature		-65 to +150	$^\circ\text{C}$
T_j	junction temperature		150	$^\circ\text{C}$

ELECTRICAL CHARACTERISTICS @ Ta=25°C unless otherwise specified

SYMBOL	PARAMETER	CONDITIONS	MIN.	MAX.	UNIT
I_{CBO}	collector cut-off current	$I_E = 0; V_{CB} = 30\text{ V}$	-	50	nA
I_{EBO}	emitter cut-off current	$I_C = 0; V_{EB} = 6\text{ V}$	-	50	nA
h_{FE}	DC current gain	$V_{CE} = 1\text{ V};$ $I_C = 0.1\text{ mA}$	60	-	
		$I_C = 1\text{ mA}$	80	-	
		$I_C = 10\text{ mA}$	100	300	
		$I_C = 50\text{ mA}$	60	-	
		$I_C = 100\text{ mA}$	30	-	
$V_{CE(sat)}$	collector-emitter saturation voltage	$I_C = 10\text{ mA}; I_B = 1\text{ mA}$	-	200	mV
		$I_C = 50\text{ mA}; I_B = 5\text{ mA}$	-	300	mV
$V_{BE(sat)}$	base-emitter saturation voltage	$I_C = 10\text{ mA}; I_B = 1\text{ mA}$	650	850	mV
		$I_C = 50\text{ mA}; I_B = 5\text{ mA}$	-	950	mV
C_{obo}	Output Capacitance	$I_E = I_e = 0; V_{CB} = 5\text{ V};$ $f = 1\text{ MHz}$	-	4	pF
C_{ibo}	Input Capacitance	$I_C = I_c = 0; V_{BE} = 500\text{ mV};$ $f = 1\text{ MHz}$	-	8	pF
f_T	transition frequency	$I_C = 10\text{ mA}; V_{CE} = 20\text{ V};$ $f = 100\text{ MHz}$	300	-	MHz
F	noise figure	$I_C = 100\text{ mA}; V_{CE} = 5\text{ V};$ $R_S = 1\text{ k}\Omega; f = 10\text{ Hz to } 15.7\text{ kHz}$	-	5	dB
Switching times (between 10% and 90% levels);					
t_d	delay time	$V_{CC} = 3\text{ Vdc}, V_{BE} = -0.5\text{ Vdc}$	-	35	ns
t_r	rise time	$I_C = 10\text{ mA}, I_B = 1\text{ mA}$	-	35	ns
t_s	storage time	$V_{CC} = 3\text{ Vdc}, I_C = 10\text{ mA}$	-	200	ns
t_f	fall time	$I_B = I_{B2} = 1\text{ mA}$	-	50	ns

 Note Pulse test: $t_p \leq 300\text{ ms}; d \leq 0.02$.

TYPICAL CHARACTERISTICS @ $T_a=25^\circ\text{C}$ unless otherwise specified

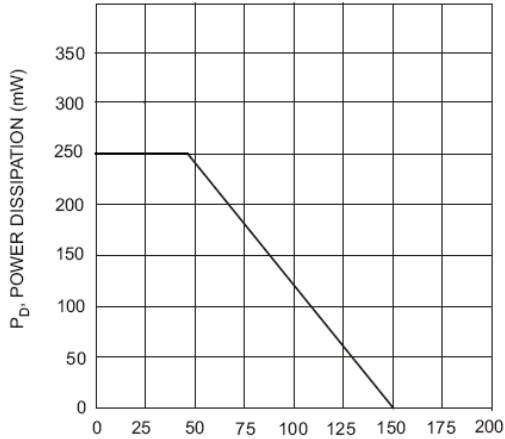

T_A , AMBIENT TEMPERATURE ($^\circ\text{C}$)
Fig. 1, Max Power Dissipation vs Ambient Temperature

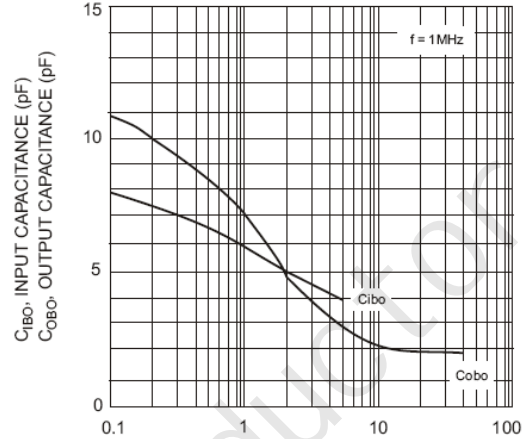

V_{CB} , COLLECTOR-BASE VOLTAGE (V)
Fig. 2, Input and Output Capacitance vs. Collector-Base Voltage

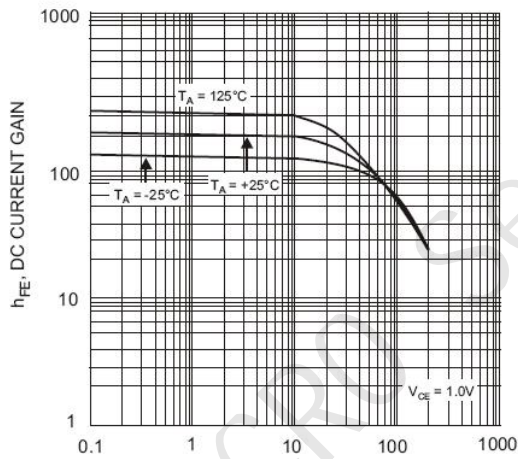

I_C , COLLECTOR CURRENT (mA)
Fig. 3, Typical DC Current Gain vs Collector Current

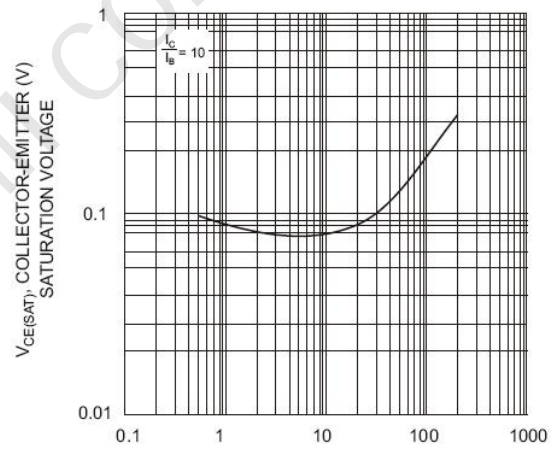

I_C , COLLECTOR CURRENT (mA)
Fig. 4, Typical Collector-Emitter Saturation Voltage vs. Collector Current

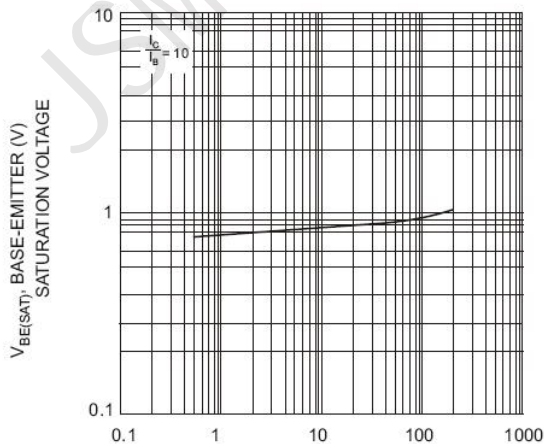

I_C , COLLECTOR CURRENT (mA)
Fig. 5, Typical Base-Emitter Saturation Voltage vs. Collector Current

PACKAGE OUTLINE

Plastic surface mounted package

SOT-23

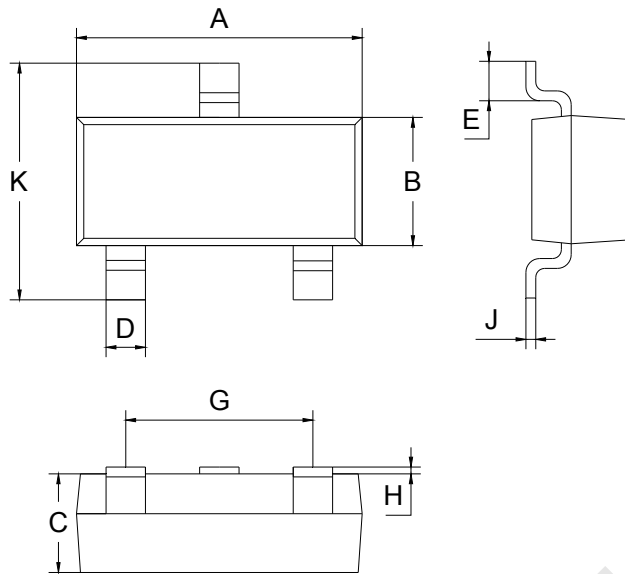

SOT-23		
Dim	Min	Max
A	2.70	3.10
B	1.10	1.50
C	0.90	1.10
D	0.30	0.50
E	0.35	0.48
G	1.80	2.00
H	0.02	0.10
J	0.05	0.15
K	2.20	2.60
All Dimensions in mm		

SOLDERING FOOTPRINT

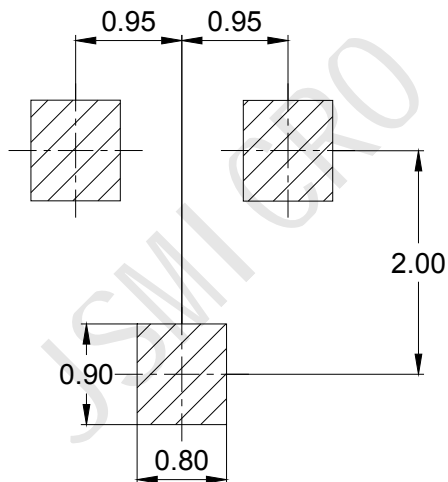

Unit: mm

PACKAGE INFORMATION

Device	Package	Shipping
MMBT3904	SOT-23	3000pcs / Tape & Reel