

**Small Signal Diode**

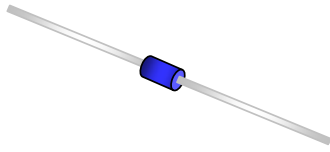

**DO-35 Axial Lead**  
**HERMETICALLY SEALED GLASS**

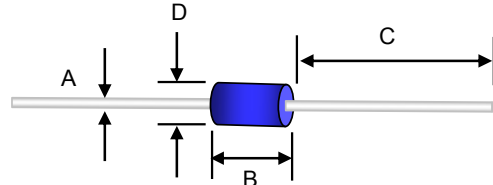

**Features**

- ✧ Designed for through-Hole Device Type Mounting.
- ✧ Hermetically Sealed Glass.
- ✧ All external surface are corrosion resistant and terminals are readily solderable.
- ✧ High reliability glass passivation insuring parameter stability and protection against junction contamination.
- ✧ Pb free version and RoHS compliant

**Mechanical Data**

- ✧ Case :DO-35 Solder Hot Dip Tin (Sn) lead finish
- ✧ Terminal: Pure tin plated, lead free., solderable per MIL-STD-202, Method 208 guaranteed
- ✧ High temperature soldering guaranteed: 260°C/10s
- ✧ Marking : DB3/DB3TG
- ✧ Weight : 0.1255 gram (approximately)

Dimensions	Unit (mm)		Unit (inch)	
	Min	Max	Min	Max
A	0.45	0.55	0.018	0.022
B	3.05	4.00	0.120	0.157
C	25.4	38.1	1.000	1.500
D	1.53	2.28	0.060	0.090

**Ordering Information**

Package	Part No.	Packing	Marking
DO-35	DB3 RI	5K / 10" Reel	DB3
DO-35	DB3TG RI	5K / 10" Reel	DB3TG

**Maximum Ratings and Electrical Characteristics**

Rating at 25°C ambient temperature unless otherwise specified.

**Maximum Ratings**

Type Number	Symbol	Value	Units
Power Dissipation	$P_D$	150	mW
Repetitive Peak Forward Current Pulse Width= 20µsec	$I_{FRM}$	2	A
Thermal Resistance (Junction to Ambient) (Note 1)	$R_{\theta JA}$	400	°C/W
Junction and Storage Temperature Range	$T_J, T_{STG}$	-40 to + 125	°C

Notes:1. Valid provided that electrodes are kept at ambient temperature

**Small Signal Diode**

**Electrical Characteristics**

Type Number		Symbol	DB3	DB3TG	Units	
Break-over Voltage	C= 22nF	$V_{BO}$	Min.	28	30	V
			Typ.	32	32	
			Max.	36	34	
Break-over Voltage Symmetry	C= 22nF	+ / - $V_{BO}$	Max.	+ / - 3	+ / - 2	V
Break-over Current	C= 22nF	$I_{BO}$	Max.	100	15	$\mu A$
Dynamic Breakover Voltage	$I_{BO}$ to $I_F=10mA$	$\Delta V$	Min.	5	9	V
Leakage Current	$V_B= 0.5V_{BO}$ (MAX)	$I_B$	Max.	10		$\mu A$
Output Voltage	*see diagram 1	$V_o$	Min.	5		V

**Tape & Reel specification**

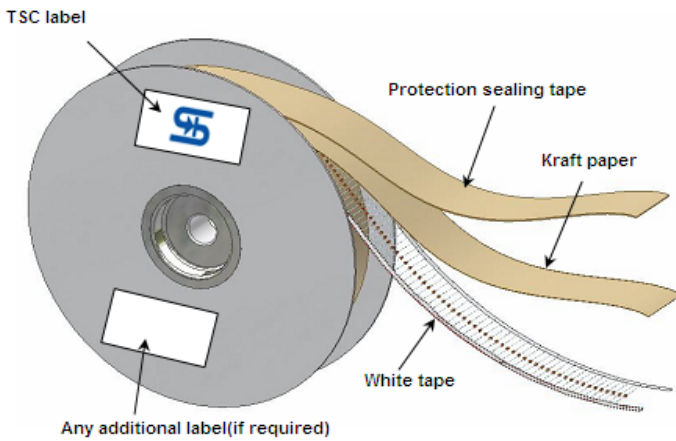

Item	Symbol	Dimension(mm)
Overall width	A	64+1.69/-0.69
Tape spacing	B	52.0+/-0.69
Component Pitch	C	5.08+/-0.40
Untaped lead	L1-L2	+/-0.69
Bent	K	1.2 Max
Tape Mismatch	E	0.55(MAX)
Glass offset	F	0.69(MAX)
Taped lead	G	3.2Min
lead beyond tape	H	0
Reel outside diameter	D	260+/-3
Reel inner diameter	D1	48+/-1
Feed hole width	D2	20+/-0.5
Reel width	W1	72+3/-1

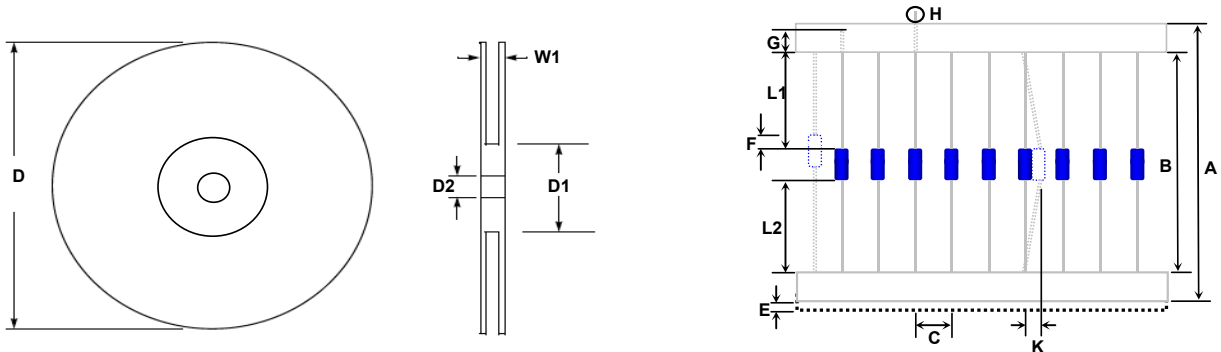

**Small Signal Diode**

**Rating and Characteristic Curves**

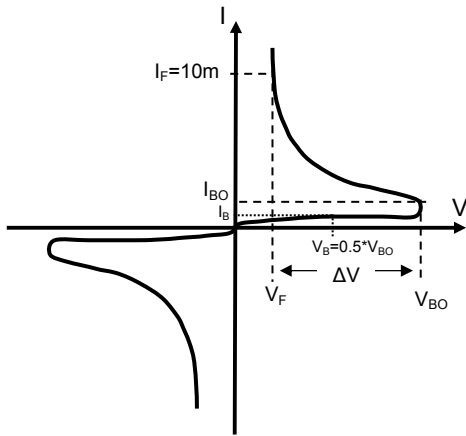

- $V_{BO}$  : Break-Over Voltage
- $I_{BO}$  : Break-Over Current
- $\Delta V$  : Dynamic Breakover Voltage
- $I_B$  : Leakage Current at  $V_B = 0.5 * V_{BO}$
- $V_F$  : Voltage at Current  $I_F = 10mA$

**Diagram 1: Test Circuit**

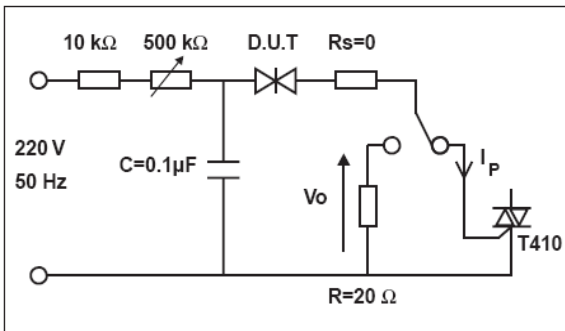

**FIG 1 Admissible Power Dissipation Curve**

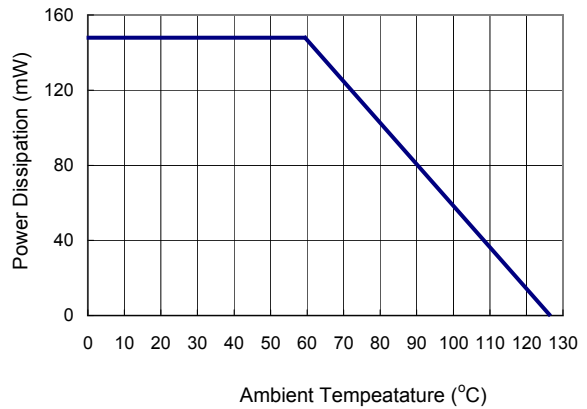

**FIG 2 Relative variation of VBO versus junction temperature (typical values)**

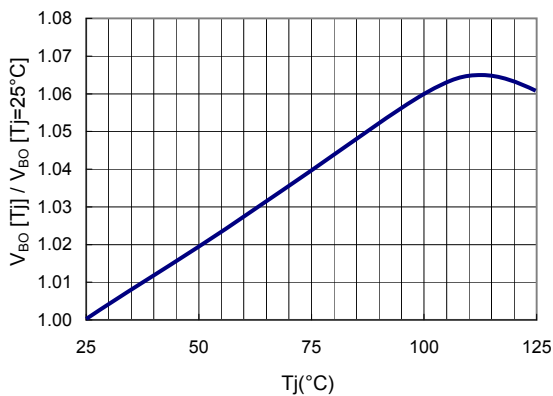

**FIG 3 Repetitive peak pulse current versus pulse duration (maximum values)**

