

High Intensity SMD LED

Description

This device has been designed to meet the increasing demand for white SMD LED.

The package of the TLMW310. is the PLCC-2 (equivalent to a size B tantalum capacitor).

It consists of a lead frame which is embedded in a white thermoplast. The reflector inside this package is filled with a mixture of epoxy and TAG phosphor.

The TAG phosphor converts the blue emission partially to yellow, which mixes with the remaining blue to give white.

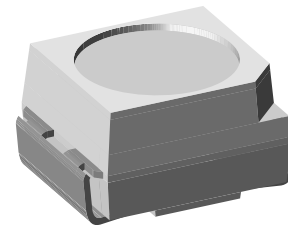

19225



Features

- High efficient InGaN technology
- Chromaticity Coordinate categorized according to CIE1931 per packing unit
- Luminous intensity ratio in one packing unit
 $I_{Vmax}/I_{Vmin} \leq 1.6$
- Typical color temperature 5500 K
- ESD class 1
- EIA and ICE standard package
- Compatible with infrared, vapor phase and wave solder processes according to CECC
- Available in 8 mm tape reel
- Lead-free device

Applications

Automotive: Backlighting in dashboards and switches
 Telecommunication: Indicator and backlighting in telephone and fax
 Backlighting for audio and video equipment
 Backlighting in office equipment
 Indoor and outdoor message boards
 Flat backlight for LCDs, switches and symbols
 Illumination purposes, alternative to incandescent lamps
 General use

Parts Table

Part	Color, Luminous Intensity	Angle of Half Intensity ($\pm\phi$)	Technology
TLMW3100	White, $I_V > 80$ mcd	60 °	InGaN / TAG on SiC
TLMW3101	White, $I_V = (80 \text{ to } 200)$ mcd	60 °	InGaN / TAG on SiC
TLMW3102	White, $I_V = (125 \text{ to } 320)$ mcd	60 °	InGaN / TAG on SiC

Absolute Maximum Ratings

$T_{amb} = 25$ °C, unless otherwise specified

TLMW310.

Parameter	Test condition	Symbol	Value	Unit
Reverse voltage		V_R	5	V
DC Forward current	$T_{amb} \leq 70$ °C	I_F	20	mA
Surge forward current	$t_p \leq 10$ μ s	I_{FSM}	0.1	A
Power dissipation	$T_{amb} \leq 70$ °C	P_V	85	mW
Junction temperature		T_j	100	°C
Operating temperature range		T_{amb}	- 40 to + 100	°C

Parameter	Test condition	Symbol	Value	Unit
Storage temperature range		T_{stg}	- 40 to + 100	°C
Soldering temperature	$t \leq 5$ s	T_{sd}	260	°C
Thermal resistance junction/ambient	mounted on PC board (pad size > 16 mm ²)	R_{thJA}	350	K/W

Optical and Electrical Characteristics

$T_{amb} = 25$ °C, unless otherwise specified

White

TLMW310.

Parameter	Test condition	Part	Symbol	Min	Typ.	Max	Unit
Luminous intensity ¹⁾	$I_F = 20$ mA	TLMW3100	I_V	80	140		mcd
		TLMW3101	I_V	80		200	mcd
		TLMW3102	I_V	125		320	mcd
Chromaticity coordinate x acc. to CIE 1931	$I_F = 20$ mA	TLMW3100	x		0.33		
Chromaticity coordinate y acc. to CIE 1931	$I_F = 20$ mA	TLMW3100	y		0.33		
Angle of half intensity	$I_F = 20$ mA		ϕ		± 60		deg
Forward voltage	$I_F = 20$ mA		V_F		3.5	4.2	V
Reverse voltage	$I_R = 10$ μ A		V_R	5			V
Temperature coefficient of V_F	$I_F = 20$ mA		TC_{VF}		- 4		mV/K
Temperature coefficient of I_V	$I_F = 20$ mA		TC_{IV}		- 0.5		% / K

¹⁾ in one Packing Unit $I_{Vmax}/I_{Vmin} \leq 1.6$

Typical Characteristics ($T_{amb} = 25$ °C unless otherwise specified)

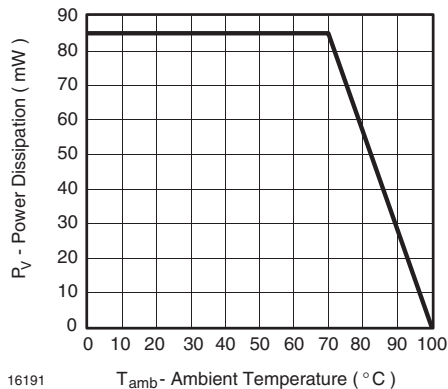

Figure 1. Power Dissipation vs. Ambient Temperature

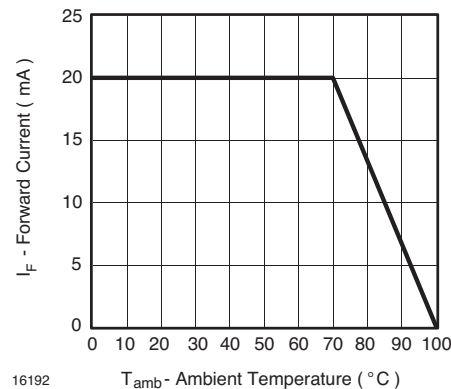

Figure 2. Forward Current vs. Ambient Temperature for AlInGaP

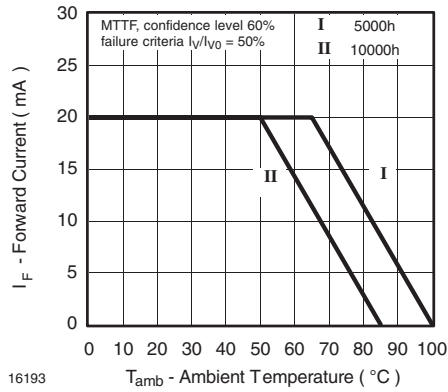

Figure 3. Forward Current vs. Ambient Temperature for AlInGaP

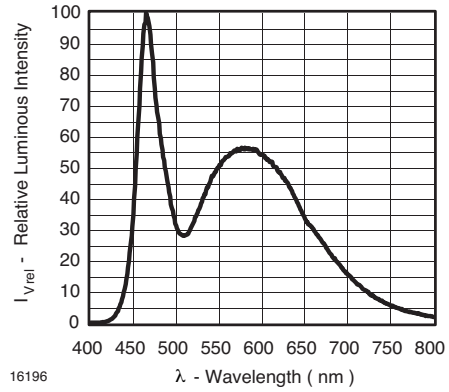

Figure 6. Relative Intensity vs. Wavelength

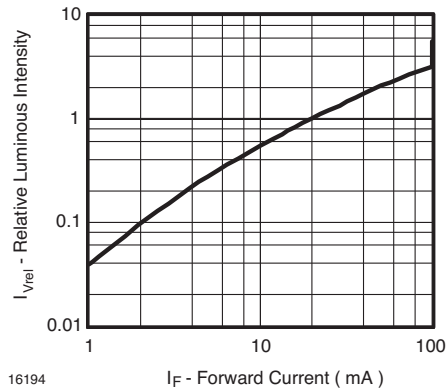

Figure 4. Relative Luminous Intensity vs. Forward Current

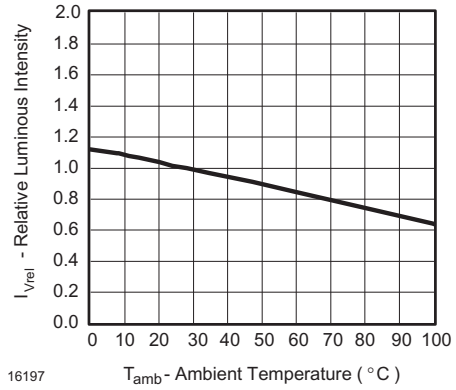

Figure 7. Rel. Luminous Intensity vs. Ambient Temperature

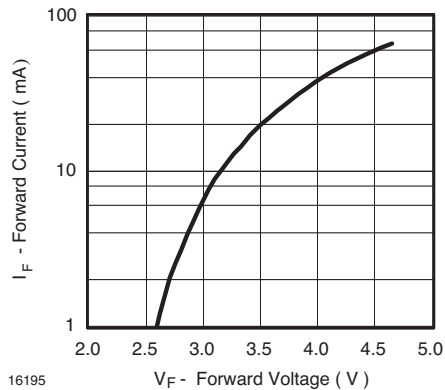

Figure 5. Forward Current vs. Forward Voltage

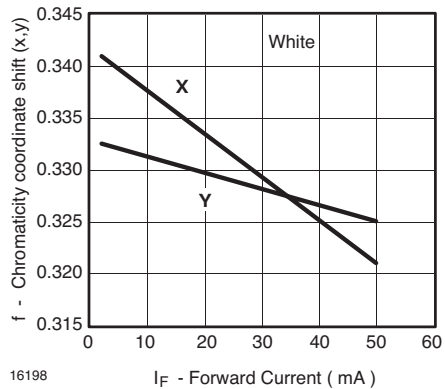

Figure 8. Chromaticity Coordinate Shift vs. Forward Current

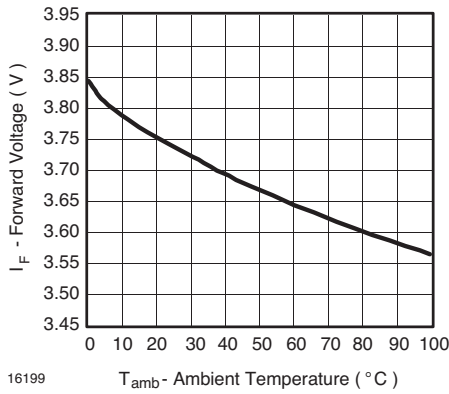
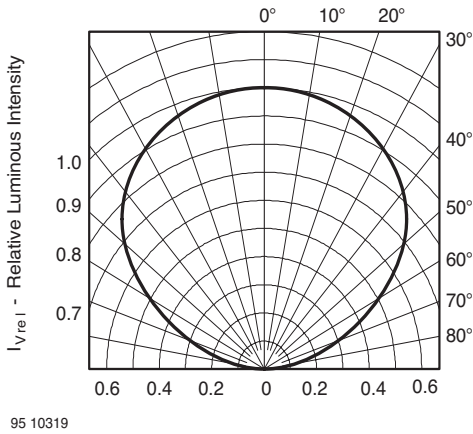
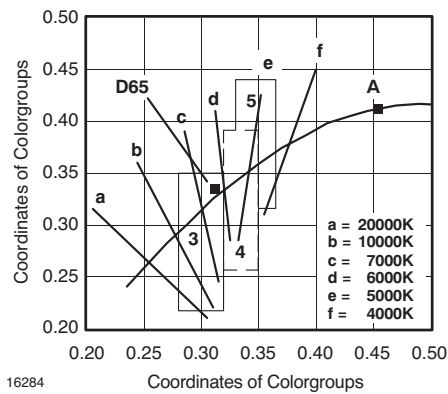

Figure 9. Forward Voltage vs. Ambient Temperature



95 10319

Figure 10. Rel. Luminous Intensity vs. Angular Displacement



16284

Figure 11. Coordinates of Colorgroups

Package Dimensions in mm

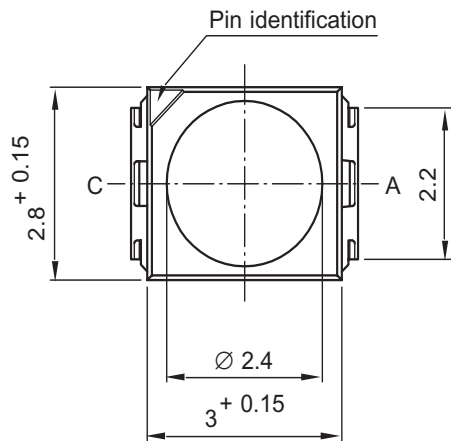
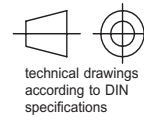
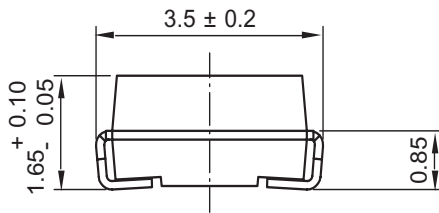

Mounting Pad Layout

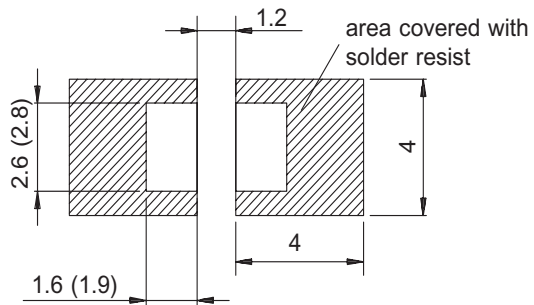

Dimensions: IR and Vaporphase
 (Wave Soldering)

Drawing-No. : 6.541-5025.01-4
 Issue: 7; 05.04.04

95 11314

Ozone Depleting Substances Policy Statement

It is the policy of **Vishay Semiconductor GmbH** to

1. Meet all present and future national and international statutory requirements.
2. Regularly and continuously improve the performance of our products, processes, distribution and operating systems with respect to their impact on the health and safety of our employees and the public, as well as their impact on the environment.

It is particular concern to control or eliminate releases of those substances into the atmosphere which are known as ozone depleting substances (ODSs).

The Montreal Protocol (1987) and its London Amendments (1990) intend to severely restrict the use of ODSs and forbid their use within the next ten years. Various national and international initiatives are pressing for an earlier ban on these substances.

Vishay Semiconductor GmbH has been able to use its policy of continuous improvements to eliminate the use of ODSs listed in the following documents.

1. Annex A, B and list of transitional substances of the Montreal Protocol and the London Amendments respectively
2. Class I and II ozone depleting substances in the Clean Air Act Amendments of 1990 by the Environmental Protection Agency (EPA) in the USA
3. Council Decision 88/540/EEC and 91/690/EEC Annex A, B and C (transitional substances) respectively.

Vishay Semiconductor GmbH can certify that our semiconductors are not manufactured with ozone depleting substances and do not contain such substances.

**We reserve the right to make changes to improve technical design
and may do so without further notice.**

Parameters can vary in different applications. All operating parameters must be validated for each customer application by the customer. Should the buyer use Vishay Semiconductors products for any unintended or unauthorized application, the buyer shall indemnify Vishay Semiconductors against all claims, costs, damages, and expenses, arising out of, directly or indirectly, any claim of personal damage, injury or death associated with such unintended or unauthorized use.

Vishay Semiconductor GmbH, P.O.B. 3535, D-74025 Heilbronn, Germany
Telephone: 49 (0)7131 67 2831, Fax number: 49 (0)7131 67 2423